



Level TROLL 400, 500, 700, and 700H

## Operator's Manual



# Contents

<b>Introduction .....</b>	<b>5</b>
Scope .....	5
Serial number location.....	5
Certification.....	5
Unpacking and inspection .....	5
Warranty.....	5
Contact Information.....	5
Mailing and Shipping Address: .....	5
In-Situ .....	5
<b>Product Specifications .....</b>	<b>6</b>
Level TROLL 400 instrument .....	6
Level TROLL 500 instrument .....	8
Level TROLL 700 instrument .....	10
Level TROLL 700H instrument .....	12
BaroTROLL instrument .....	14
Rugged Cable system.....	16
Suspension wire .....	17
<b>About the Pressure/Level Sensor .....</b>	<b>18</b>
Configuring depth and level for PLC or data logger .....	20
System components .....	21
Power options .....	26
Installation accessories .....	28
<b>Getting started .....</b>	<b>30</b>
Connect the instrument to a Wireless TROLL Com. ....	30
Connect to VuSitu .....	30
Configure and deploy the instrument.....	30
<b>Navigating VuSitu.....</b>	<b>31</b>
About VuSitu.....	31
Connected Instrument Screen .....	31
Live Readings Screen.....	32
Snapshot Mode.....	32
Live Readings Mode.....	32
Changing Parameters and Units.....	33
Downloading and Sharing Your Data .....	33
Sharing Data .....	34

Viewing Data on a Mac or PC.....	34
<b>Field deployment.....</b>	<b>35</b>
Program the instrument.....	35
Position the instrument.....	35
Verify instrument depth.....	36
Secure the cable.....	36
Install the desiccant.....	37
<b>Connecting the Level TROLL to a PLC or Data Logger .....</b>	<b>41</b>
Flying Leads Wire Diagram .....	42
Power connections.....	43
Communication modes.....	43
Redundant logging .....	43
Analog (4-20 mA) wiring diagram.....	43
SDI-12 wiring diagram .....	44
Modbus (RS485) wiring diagram.....	45
Modbus (RS232 with converter) wiring diagram .....	46
<b>Configuring SDI-12 Settings .....</b>	<b>47</b>
About SDI-12 .....	47
Configure SDI-12 Settings in VuSitu .....	47
<b>Modbus PLC Interface .....</b>	<b>47</b>
Overview .....	47
Setting Up Instrument .....	48
Programming the PLC .....	48
Reading Device Information .....	48
Reading Parameters .....	49
<b>Win-Situ overview .....</b>	<b>50</b>
Data tab .....	50
Home tab .....	51
Logging tab.....	52
Sensors tab.....	54
Device setup tab.....	55
Using Win-Situ 5 software.....	56
Using BaroMerge software .....	63
<b>Cleaning &amp; maintenance .....</b>	<b>65</b>
Overview .....	65
Operating considerations .....	65
Desiccant pack options.....	66
Installing desiccant with Twist-lock connectors .....	67

Installing outboard desiccant.....	67
Using the desiccant refill kit.....	68
Antifouling.....	68
O-ring inspection and replacement.....	68
Cleaning the instrument .....	69
Twist-lock connectors.....	69
Storage.....	69
Factory calibration and service .....	70
Guidelines for cleaning returned equipment.....	71
Troubleshooting.....	72
<b>Declarations of Conformity and Similarity.....</b>	<b>74</b>
Level TROLL 400.....	74
Level TROLL 500.....	76
Level TROLL 700.....	78
BaroTROLL .....	80
TROLL Battery Pack.....	82
TROLL Com Communication Device.....	84
<b>Appendix .....</b>	<b>86</b>
Appendix A: Parameter Numbers and Locations .....	86
Appendix B: Unit IDs .....	87

# Introduction

The Level TROLL Instrument is a compact, modular system for measuring level and temperature in natural groundwater, surface water, industrial waters, and other installations.

## Scope

This document is intended to describe the characteristics, operation, calibration, and maintenance of the instrument. Communication registers and SDI-12 programming information can be found in the Modbus and SDI-12 Reference Guides on the In-Situ website.

## Serial number location

The serial number is engraved on the instrument housing. It is also programmed into the instrument and is displayed when the instrument is connected to a computer running Win-Situ Software.

## Certification

See the Declarations of conformity at end of this manual.

## Unpacking and inspection

Your instrument was carefully inspected before shipping. Check for any physical damage sustained during shipment. Notify In-Situ and file a claim with the carriers involved if there is any shipping damage. Accessories may be shipped separately and should also be inspected for physical damage and the fulfillment of your order.



Please save packing materials for future storage and shipping. The shipping boxes have been performance-tested and provide protection for the instrument and its accessories.

## Warranty

See the product specification tables for warranty information.

## Contact Information

### Mailing and Shipping Address:

In-Situ  
221 East Lincoln Avenue  
Fort Collins, CO 80524  
U.S.A.

Phone: 1-970-498-1500 (international & domestic)

Fax: 1-970-498-1598

Internet: [www.in-situ.com](http://www.in-situ.com)

Support: 1-800-446-7488 (U.S.A. & Canada)

# Product Specifications

## Level TROLL 400 instrument

General	Level TROLL 400
Temperature ranges	Operational: -20-80° C (-4-176° F) Storage: -40-80° C (-40-176° F) Calibrated: -5-50° C (23-122° F)
Diameter	1.83 cm (0.72 in.)
Length	21.6 cm (8.5 in.)
Weight	124 g (0.27 lb)
Materials	Titanium, FKM Fluoroelastomer, Acetal
Output options	Modbus/RS485, SDI-12, 4-20 mA
Battery type & life	3.6 V lithium; 10 years or 2M readings
External power	8-36 VDC
Memory	2.0 MB
Data records	130,000
Data logs	50
Log types	Linear, Fast Linear, and Event
Fastest logging rate & Modbus rate	2 per second
Fastest SDI-12 & 4-20 mA output rate	1 per second
Real-time clock	Accurate to 1 second/24-hr period
Sensor type/material	Piezoresistive; titanium
Calibrated range (usable depth)	Absolute (non-vented) 30 psia (11 m, 35 ft) 100 psia (60 m, 197 ft) 300 psia (200 m, 658 ft) 500 psia (341 m, 1120 ft)
Burst pressure	Max. 2x range; burst > 3x range

Accuracy (FS)	±0.05%
Long-term stability	< 0.1% FS
Resolution	±0.005% FS or better
Units of measure	Pressure: psi, kPa, bar, mbar, mmHg, inHg, cmH2O, inH2O Level: in, ft, mm, cm, m
<b>Temperature sensor</b>	
Accuracy & resolution	±0.1° C; 0.01° C or better
Units of measure	Celsius or Fahrenheit
<b>Warranty</b>	<b>3 years</b> <b>Extended warranties are available for all instruments—call for details</b>
Footnotes	<sup>1</sup> Temperature range for non-freezing liquids <sup>2</sup> Typical battery life when used within the factory-calibrated temperature range <sup>3</sup> 1 data record = date/time plus 2 parameters logged (no wrapping) from device within the factory-calibrated temperature range <sup>4</sup> Across factory-calibrated pressure and temperature ranges. Defined as greater than 98% of all readings fall within spec across full temperature and pressure <sup>5</sup> Includes linearity and hysteresis over one year Specifications are subject to change without notice. Delrin is a registered trademark of E.I. du Pont de Nemours and Company.

## Level TROLL 500 instrument

General	Level TROLL 500
Temperature ranges	Operational: -20-80° C (-4-176° F) Storage: -40-80° C (-40-176° F) Calibrated: -5-50° C (23-122° F)
Diameter	1.83 cm (0.72 in.)
Length	21.6 cm (8.5 in.)
Weight	124 g (0.27 lb)
Materials	Titanium, FKM Fluoroelastomer, Acetal
Output options	Modbus/RS485, SDI-12, 4-20 mA
Battery type & life	3.6 V lithium; 10 years or 2M readings
External power	8-36 VDC
Memory Data records Data logs	2.0 MB 130,000 50
Log types	Linear, Fast Linear, and Event
Fastest logging rate & Modbus rate	2 per second
Fastest SDI-12 & 4-20 mA output rate	1 per second
Real-time clock	Accurate to 1 second/24-hr period
Sensor type/material	Piezoresistive; titanium
Calibrated range (usable depth)	Gauged (vented) 5 psig (3.5 m, 11.5 ft) 15 psig (11 m, 35 ft) 30 psig (21 m, 69 ft) 100 psig (70 m, 231 ft) 300 psig (210 m, 692 ft) 500 psig (351 m, 1153 ft)



Burst pressure	Max. 2x range; burst > 3x range
Accuracy (FS)	±0.05%
Resolution	±0.005% FS or better
Long-term stability	< 0.1% FS
Units of measure	Pressure: psi, kPa, bar, mbar, mmHg, inHg, cmH <sub>2</sub> O, inH <sub>2</sub> O Level: in, ft, mm, cm, m
<b>Temperature sensor</b>	
Accuracy & resolution	±0.1° C; 0.01° C or better
Units of measure	Celsius or Fahrenheit
<b>Warranty</b>	<b>3 years</b> <b>Extended warranties are available for all instruments—call for details</b>
Footnotes	See page 7.

## Level TROLL 700 instrument

General	Level TROLL 700
Temperature ranges	Operational: -20-80° C (-4-176° F) Storage: -40-80° C (-40-176° F) Calibrated: -5-50° C (23-122° F)
Diameter	1.83 cm (0.72 in.)
Length	21.6 cm (8.5 in.)
Weight	124 g (0.27 lb)
Materials	Titanium, FKM Fluoroelastomer, Acetal
Output options	Modbus/RS485, SDI-12, 4-20 mA
Battery type & life	3.6 V lithium; 10 years or 2M readings
External power	8-36 VDC
Memory Data records Data logs	4.0 MB 260,000 50
Log types	Linear, Fast Linear, Linear Average, Event, Step Linear, True Logarithmic
Fastest logging rate & Modbus rate	4 per second
Fastest SDI-12 & 4-20 mA output rate	1 per second
Real-time clock	Accurate to 1 second/24-hr period
<b>Sensor type/material</b>	<b>Piezoresistive; titanium</b>

Calibrated range (usable depth)	Absolute (non-vented) 30 psia (11 m, 35 ft) 100 psia (60 m, 197 ft) 300 psia (200 m, 658 ft) 500 psia (341 m, 1120 ft) 1000 psia (693 m, 2273 ft) Gauged (vented) 5 psig (3.5 m, 11.5 ft) 15 psig (11 m, 35 ft) 30 psig (21 m, 69 ft) 100 psig (70 m, 231 ft) 300 psig (210 m, 692 ft) 500 psig (351 m, 1153 ft)
Burst pressure	Max. 2x range; burst > 3x range
Accuracy (FS)	±0.05%
Resolution	±0.005% FS or better
Long-term stability	< 0.1% FS
Units of measure	Pressure: psi, kPa, bar, mbar, mmHg, inHg, cmH2O, inH2O Level: in, ft, mm, cm, m
<b>Temperature sensor</b>	
Accuracy & resolution	±0.1° C; 0.01° C or better
Units of measure	Celsius or Fahrenheit
<b>Warranty</b>	<b>3 years</b> <b>Extended warranties are available for all instruments—call for details</b>
Footnotes	See page 7.

## Level TROLL 700H instrument

Comply with the Office of Surface Water by using the most accurate pressure transducer available. The Level TROLL 700H meets the surface-water specification of  $\pm 0.01$  foot.

For accuracy under all operating conditions, instruments are calibrated over the full pressure and temperature range. Each instrument includes a serialized, NIST-traceable calibration report.

General	Level TROLL700H
Temperature ranges	Operational: -20-80° C (-4-176° F) Storage: -40-80° C (-40-176° F) Calibrated: 0-40° C (32-104° F)
Diameter	1.83 cm (0.72 in.)
Length	21.6 cm (8.5 in.)
Weight	124 g (0.27 lb)
Materials	Titanium, FKM Fluoroelastomer, Acetal
Output options	Modbus/RS485, SDI-12, 4-20 mA
Battery type & life	3.6 V lithium; 10 years or 2M readings
External power	8-36 VDC
Memory Data records Data logs	4.0 MB 260,000 50
Log types	Linear, Fast Linear, Linear Average, Event, Step Linear, True Logarithmic
Fastest logging rate & Modbus rate	4 per second
Fastest SDI-12 & 4-20 mA output rate	1 per second
Real-time clock	Accurate to 1 second/24-hr period
Pressure sensor type/material	Piezoresistive; titanium
Calibrated range (usable depth)	Gauged (vented) 15 psig (11 m, 35 ft)
Burst pressure	Max. 2x range; burst > 3x range
Accuracy	$\pm 0.01$ foot up to 15 ft and $\pm 0.1\%$ of reading > 15 ft

Resolution	±0.005% FS or better
Units of measure	Pressure: psi, kPa, bar, mbar, mmHg, inHg, cmH2O, inH2O Level: mm, cm, m, in, ft,
<b>Temperature sensor</b>	
Accuracy & resolution	±0.1° C; 0.01° C or better
Units of measure	Celsius or Fahrenheit
<b>Warranty</b>	<b>3 years</b> <b>Extended warranties are available for all instruments—call for details</b>
Footnotes	See page 7.

## BaroTROLL instrument

The titanium BaroTROLL measures and logs barometric pressure and temperature. Use the BaroTROLL in conjunction with non-vented In-Situ Instruments.

Win-Situ BaroMerge Software simplifies post-correction of water level data by automatically subtracting barometric readings from data collected by a non-vented instrument to compensate for changes in pressure due to barometric fluctuations.

General	BaroTROLL
Temperature ranges	Operational: -20-80° C (-4-176° F) Storage: -40-80° C (-40-176° F) Calibrated: -5-50° C (23-122° F)
Diameter	1.83 cm (0.72 in.)
Length	21.6 cm (8.5 in.)
Weight	124 g (0.27 lb)
Materials	Titanium, FKM Fluoroelastomer, Acetal
Output options	Modbus/RS485, SDI-12, 4-20 mA
Battery type & life	3.6 V lithium; 10 years or 2M readings
External power	8-36 VDC
Memory Data records Data logs	1.0 MB 65,000 2
Log types	Linear
Fastest logging rate & Modbus rate	1 per minute
Fastest SDI-12 & 4-20 mA output rate	1 per second
Real-time clock	Accurate to 1 second/24-hr period
Sensor type/material	Piezoresistive; titanium
Calibrated range (usable depth)	30 psia (usable up to 16.5 psi, 1.14 bar)
Burst pressure	Vacuum/over-pressure above 16.5 psi damages sensor
Accuracy @ 15° C	±0.1% FS

Accuracy (FS)	±0.2% FS
Resolution	±0.005% FS or better
Units of measure	Pressure: psi, kPa, bar, mbar, mmHg, inHg, cmH2O, inH2O
<b>Temperature sensor</b>	
Accuracy & resolution	±0.1° C; 0.01° C or better
Units of measure	Celsius or Fahrenheit
<b>Warranty</b>	<b>3 years Extended warranties are available for all instruments—call for details</b>
Footnotes	See page 7.

## Rugged Cable system

General	Rugged Cable system
Operating temperature range	-25° to 80° C (-13° to 176° F)
Jacket options	TPU (thermoplastic polyurethane) Tefzel (ETFE fluoropolymer)
Vent options	Non-vented (absolute) Vented (gauged) with desiccant (used to mitigate moisture/humidity)
Conductors	6 conductors, 24 AWG, polypropylene insulation
Cable diameter	TPU: 6.7 mm (0.265 in.) Tefzel: 6.35 mm (0.25 in.)
Connector diameter	18.5 mm (0.73 in.)
Weight	Non-vented, TPU: 16 kg/300 m (35.6 lbs/1,000 ft) Non-vented, Tefzel: 14 kg/300 m (32 lbs/1,000 ft) Vented, TPU: 14 kg/300 m (32 lbs/1,000 ft) Vented, Tefzel: 14 kg/300 m (32 lbs/1,000 ft)
Minimum bend radius	2X cable diameter (13.5 mm; 0.54 in.)
Break strength	127 kg (280 lbs)
Maximum cable length	1,219 m (4,000 ft) for RS485
Desiccant pack (required for vented systems)	Large and extra large desiccant packs available with titanium, ABS, or flying leads termination.
<b>Warranty</b>	<b>2 years</b>



## *Suspension wire*

<b>General</b>	<b>Suspension wire</b>
Material	304 stainless steel, 7 x 7 strand
Coating	15 mil polyester elastomer insulation
Weight	0.28 kg / 30 m (0.60 lb / 100 ft)
Break strength	122 kg (270 lb) with proper clip tightening

## About the Pressure/Level Sensor

A pressure transducer senses changes in pressure, measured in force per square unit of surface area, exerted by water or other fluid on an internal media-isolated strain gauge. In-Situ offers instruments with either absolute (non-vented) or gauged (vented) pressure sensors.



The “Absolute vs. Gauged: Comparing Absolute and Gauged Pressure Sensors” technical note describes the difference between absolute and gauged pressure sensors and explains the proper use of each type of sensor in different applications.

### Absolute pressure sensor

An absolute or non-vented pressure sensor measures all pressure forces detected by the strain gauge, including atmospheric pressure (PATM). The unit of measure is PSIA (pounds per square inch absolute), measured with respect to zero pressure. The back of an absolute pressure sensor is sealed from the atmosphere. Therefore, the front of the absolute pressure sensor responds to both atmospheric pressure and the pressure head of water above the sensor.

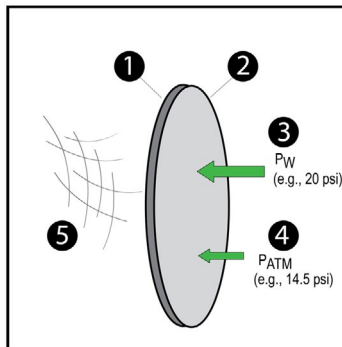

Absolute sensor	
1	Sensor back
2	Sensor front
3	Water pressure, $P_w$ (e.g., 20 PSI)
4	Atmospheric pressure $P_{ATM}$ (e.g., 14.5 PSI)
5	Vacuum

## Gauged pressure sensor

A gauged or vented pressure sensor eliminates the effects of atmospheric pressure because the vent tube in the cable allows atmospheric pressure to be applied to the back of the sensor. The unit of measure is PSIG (pounds per square inch gauge), measured with respect to atmospheric pressure.

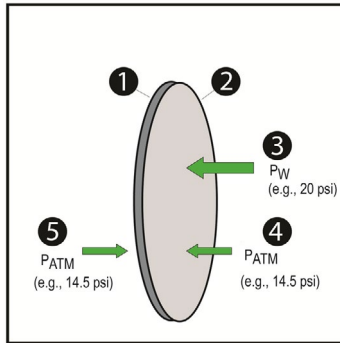

Gauged pressure sensor	
1	Sensor back
2	Sensor front
3	Water pressure, $P_w$ (e.g., 20 PSI)
4	Atmospheric pressure $P_{ATM}$ (e.g., 14.5 PSI)
5	Atmospheric pressure $P_{ATM}$ (e.g., 14.5 PSI)

## BaroTROLL atmospheric pressure sensor

Barometric pressure applies a direct stress upon open wells and surface water. Locally, barometric effects can change significantly from location to location as a result of topographical and micro-meteorological changes. Therefore, it is important to compensate for the barometric pressure changes when monitoring water elevation.

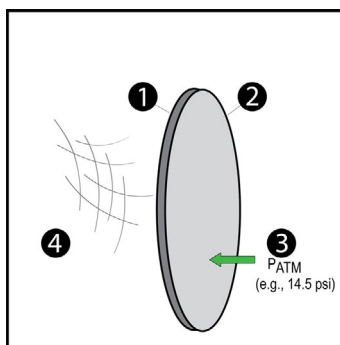

BaroTROLL sensor	
1	Sensor back
2	Sensor front
3	Atmospheric pressure $P_{ATM}$ (e.g., 14.5 PSI)
4	Vacuum

## Configuring depth and level for PLC or data logger

When you configure level using the Sensors tab, the settings are stored in the instrument and are available for use in Modbus, SDI-12, or 4-20 mA analog communication. A different configuration can be selected when you set up a log.

1. Connect the instrument to the software.
2. Click the Sensors tab.
3. Select the level/pressure sensor and click the Configure button. The Sensor Setup tab appears.



4. In the Sensor Setup window, select the level parameter, and then click Configure. The Level Setup Wizard opens.

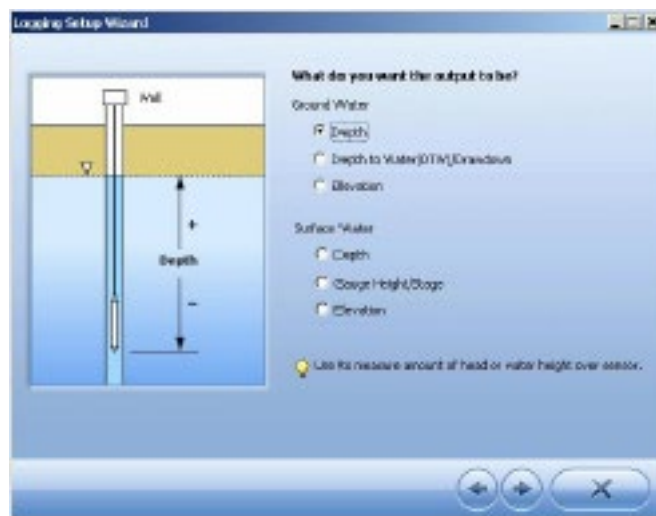

5. In the Level Setup Wizard, select the options you want. For more information, view the help inside Win-Situ 5 software.

## System components

### Instrument

The Level TROLL Instrument is completely sealed and contains no user-serviceable parts. The instrument includes pressure and temperature sensors, a real-time clock, microprocessor, sealed lithium battery, data logger, and memory. Options include a vented or non-vented pressure sensor in a variety of ranges.

### Rugged Cable system

RuggedCable Systems are custom-built, durable, direct-read cables that include the following items.

1. Titanium twist-lock connectors for quick, reliable connections to the instrument, desiccant, and communication cable
2. Metal shield beneath the cable jacket to prevent electrical interferences
3. Kellems grip for secure instrument deployment
4. Small desiccant for vented systems (for storage only)



Non-vented cables are marked with VF, which means vent free.

### Vented or non-vented

Vented cable is used with vented pressure sensors to produce gauged measurements. The cable vent tube ensures that atmospheric pressure is applied to the back of the sensor diaphragm.

Non-vented cable is used with non-vented instruments for absolute measurements. Compensate absolute measurements by using a BaroTROLL Instrument and Win-Situ Baro Merge Software.



The vented cable is shipped with a small desiccant to protect against condensation. Larger desiccants are necessary for deployment.

### Jacket options

Tefzel (vented) or thermoplastic polyurethane (TPU, vented or non-vented)

### Customizable cable lengths

Cables can be ordered up to 1,219 m (4,000 ft).

### Cable termination

Cables can be ordered with a twist-lock termination (female connector) on both ends that connect to the instrument, the TROLL Com Communication Device, desiccant, and other accessories.

Cables can also be ordered with flying leads termination for wiring to a data logger or controller using SDI-12, analog (4-20 mA), or Modbus communication protocol.



1	Rugged Cable System with female to female connectors
2	In-Situ Rugged Cable with Flying Leads with female connector
3	In-Situ Rugged Cable with Flying Leads with male connector (short length that converts a cable with a twist-lock connector to a flying leads cable)

### Suspension wire

Polyurethane-coated stainless steel suspension cable can be used to deploy instruments with non-vented pressure sensors such as the Level TROLL 400 Instrument, the non-vented Level TROLL 700 Instrument, and the BaroTROLL Instrument. Suspension wire is appropriate to use when direct communication with the instrument is not necessary during deployment.



Description	Part number
Suspension wire - 300 feet	0066450
Suspension wire - 150 feet	0066460
Suspension wire - 50 feet	0066470





## Communication cables

The TROLL Com Communication Device provides an interface between the instrument and a desktop/laptop PC for calibrating and programming the instrument and for profiling and downloading data. The TROLL Com Communication Device is offered in either a cable-connect or direct-connect configuration including a 0.9 m (3 ft) vented polyurethane cable, external power input jack, and vent with replaceable membrane.

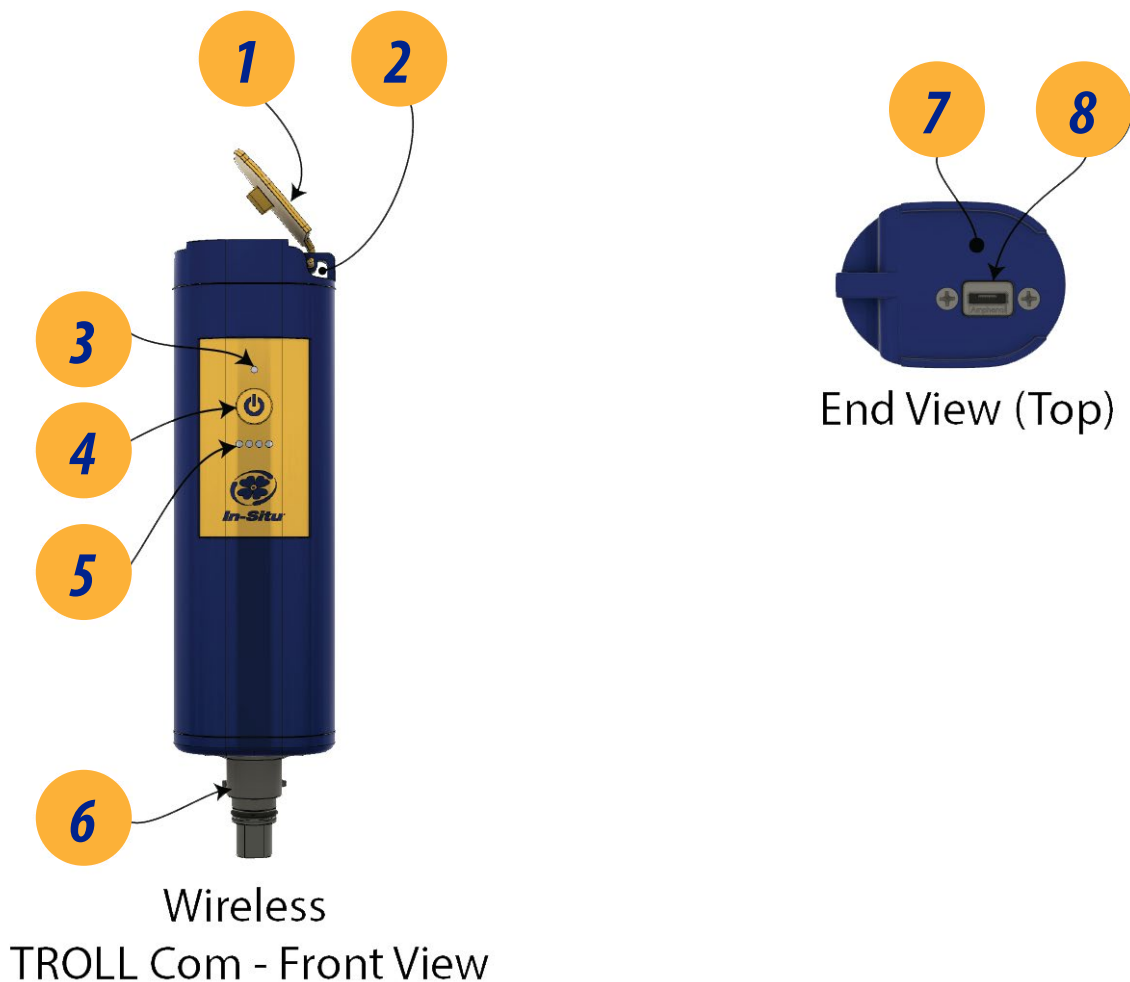
### Description

The Wireless TROLL Com enables wireless communication between a Bluetooth-enabled Android or iOS device and an instrument deployed on a cable. You can also use the Wireless TROLL Com as a replacement for a standard wired TROLL Communication Device.



1	Dust cover for the USB connection
2	<p>Connection status</p> <p>Red (flashing) = The communication device, instrument, and Bluetooth-enabled device are not connected.</p> <p>Red (continuous) = The communication device and instrument are connected, but the communication device is not connected to the Bluetooth-enabled device.</p> <p>-OR-</p> <p>The communication device is connected via USB cable.</p> <p>Green (flashing) = The communication device is connected to the Bluetooth-enabled device, but is not connected to the instrument.</p> <p>Green (continuous) = The communication device, instrument, and Bluetooth-enabled device are connected.</p>
3	On/Off button
4	<p>Battery charge status:</p> <p> 100% - 90%</p> <p> 90% - 75%</p> <p> 75% - 50%</p> <p> 50% - 25%</p> <p> Less than 25%</p>
5	Cable connector to the instrument
6	Lanyard connector
7	Serial number
8	USB connection to a power source for charging the internal battery or wired connection to a computer

### Charging the communication device

1. Remove the protective cover from the USB slot.
2. Connect the USB cable to the device.
3. Plug the USB cable into the wall charger or a powered USB port such as a computer that has a charger plugged in.
4. The device lights will turn on and blink according to charge level.



## Battery tips

A fully-charged communication device will run for up to 40-50 continuous hours.

The communication device uses an internal, rechargeable Lithium-ion (Li-ion) battery to supply power. While these batteries last for years with minimal decrease in performance, there are a few tips to prolong the life of the battery.

1. Avoid full discharges and charge the battery more often between uses.
2. Avoid storing the communication device in a high temperature (above 86° F / 30° C) area.

## Connecting to a Wireless TROLL Com

A Wireless TROLL Com can be used to connect the instrument to software if the instrument is deployed on a cable.

1. Turn on the Wireless TROLL Com.
2. Make sure the cable is connected to the instrument as well as the communication device.
3. Go to Bluetooth settings on your mobile device or computer.
4. From the Bluetooth section, search for devices.
5. Tap or click the serial number of the communication device to pair the device with the phone or computer. The serial number is located under the USB flap.

## Connecting to VuSitu

1. Open the VuSitu Mobile App. If you have correctly paired your Wireless TROLL Com with your wireless device, and the instrument is available, the software will connect and display readings.



If the Searching screen continues to show, tap "Choose another device" and select the device you are trying to connect to.

## Connecting to Win-Situ 5

1. Open Win-Situ 5 Software.
2. When prompted, "Connect to device now?" click No.
3. Plug the USB charging cable into the computer and Wireless TROLL Com.
4. Click Preferences, then click Comm Settings.
5. Select the correct Com port used by the charging cable, then select the communication settings for the instrument you are connecting. The following default communication settings are most common for In-Situ instruments:
  - Baud: 19200
  - Data Bits: 8
  - Parity Bits: Even
  - Stop Bits: 1
  - Device Address: 1
  - Mode: Modbus-RTU

If you cannot connect using these settings, click the "Search for Devices" or "Reset All Devices" button.

6. Click the checkmark, then click the Connect button in the lower right hand corner.

## Power options

### Internal power—batteries

Internal batteries are not user-replaceable. The approximate percentage of the power remaining in an internal battery is displayed on the Home Screen when an instrument is connected to Win-Situ Software. The instrument is powered by 3.6 VDC, supplied by a sealed, non-replaceable AA lithium battery. Battery life depends on sampling speed. The battery typically lasts for 10 years or 2,000,000 readings, whichever occurs first.

When an instrument is wired to a data logger or PLC controller, power to the instrument is supplied by the data logger or controller.

### AC adapter

The AC adapter provides 24 VDC, 0.75 A, AC input 100-250 V and includes a North American power cord. The TROLL Com Communication Device includes an external power input port for connection to the AC adapter.

Description	Part number
AC adapter 24 VDC	0052440



Use only In-Situ Inc.'s AC adapter. Damage to the instrument caused by the use of third-party converters is not covered by the warranty.

### External power—external battery packs

External battery packs can significantly increase the life of an instrument, either for long-term deployments or to preserve an aging instrument.

#### TROLL battery pack

The sealed, submersible TROLL Battery Pack supplements internal battery power when an instrument is used for fast, frequent sampling or during long-term deployments. When this power source is connected, the instrument will use the external battery source first and switch to the internal batteries when external battery power is depleted. Total battery life depends on the sampling speed.



Description	Part number
TROLL Battery Pack	0051450

The sealed, submersible TROLL Battery Pack supplies 14.4 V. When this power source is connected, the Level TROLL will use the external battery source first and switch to the internal batteries when external battery power is depleted.

0.5 second sampling interval	1.2 months
1 second sampling interval	2.3 months
1 minute (or longer) sampling interval	1 year

## TROLL replacement battery pack

The TROLL Replaceable Battery Pack supplements internal battery power when a Level TROLL or Aqua TROLL 100 or 200 Instrument is used for frequent, fast sampling or during long-term deployments. When this power source is connected, the TROLL instrument will use the external battery source first and switch to the internal batteries when external battery power is depleted. Battery life depends on sampling rate. This battery pack allows for 1.5 V UM-3 or size AA batteries (8) that are replaced by the user.



The TROLL replaceable battery pack is not submersible.



Description	Part number
TROLL Replaceable Battery Pack	0090000

## Estimated battery lifetime

TROLL battery pack	Level TROLL family
15 minute logging rate*	1.1 years
1 hour logging rate	1.1 years

\*Logging with all sensors. Actual battery lifetime varies based on site conditions.

TROLL replaceable battery pack	Level TROLL family
15 minute logging rate*	1.6 years
1 hour logging rate	1.7 years

\*Logging with all sensors. Actual battery lifetime varies based on site conditions.

## Installation accessories

### NPT adapter

The 0.25 in. NPT adapter allows instrument installation in piping.

Part number	Image	Description
0051470		NPT Adapter

### Cable extender

The cable extender connects two lengths of RuggedCable System to meet varying installation needs.

Part number	Image	Description
0051490		Cable Extender

### Twist-lock hanger

The Twist-Lock Hanger is used with a suspension wire to install a non-vented instrument when the user does not require direct communication.

Part number	Image	Description
0051480		Twist-lock Hanger, titanium for Level TROLL 400, 700, 700H, BaroTROLL

### Bulkhead connector

The panel-mounted bulkhead connector provides connection between RuggedCable System and a controller panel.

Part number	Image	Description
0053240		Bulkhead Connector

## Locking well cap



Description	Part number
Locking Well Cap, 2"	0020360
Locking Well Cap, 2" vented	0020370
Locking Well Cap, 4"	0020380
Locking Well Cap, 4" vented	0020390

## Well dock installation ring

The well dock installation ring provides installation support for 2", 4", and 6" well casings.

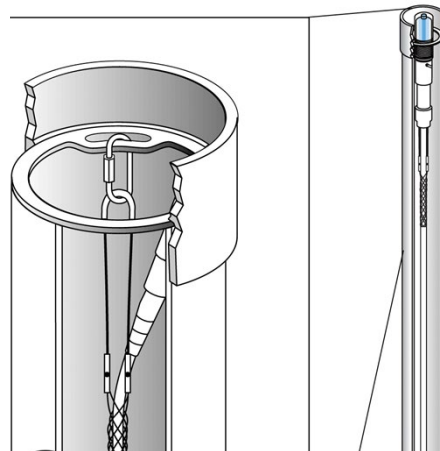

Description	Part number
Well Dock Installation Ring, 2"	0004690
Well Dock Installation Ring, 4"	0004700
Well Dock Installation Ring, 6"	0020650

# Getting started



Follow the steps below to configure and deploy the instrument.

## 1 Connect the instrument to a Wireless TROLL Com.

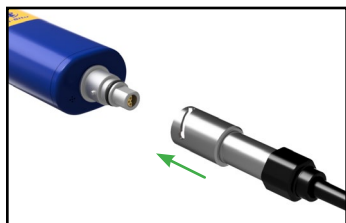

Attach the instrument's twist-lock connector to the end of the Wireless TROLL Com.

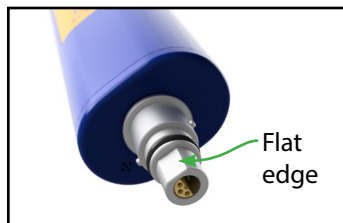

Make sure the flat edges of the connectors align, and then push and twist.



You will hear a click when the cable is connected properly.



Press the power button on the Wireless TROLL Com.



You must have the VuSitu mobile app to use the instrument with a mobile device. Download VuSitu from the Google Play Store or the Apple App Store.

## 2 Connect to VuSitu

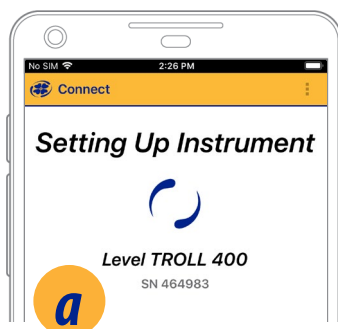

Attach an instrument and turn on the Wireless Rugged TROLL Com. Launch VuSitu to automatically connect.

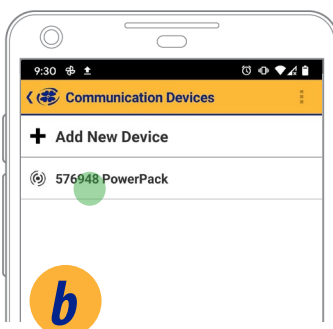

To connect to another instrument, press **Disconnect**. VuSitu displays a list of available connections.

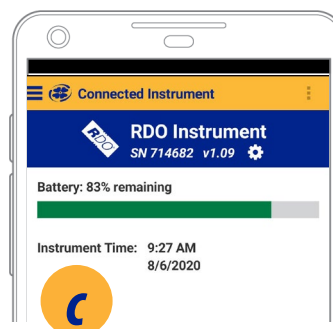

VuSitu displays the Connected Instrument screen when pairing is complete.

## 3 Configure and deploy the instrument.



VuSitu will guide you through logging, taking readings, and configuring your instrument. Use the menu options to get started.

# Navigating VuSitu

The Level TROLL can be programmed using the VuSitu Mobile App or using Win-Situ 5 Software.

## About VuSitu

VuSitu is the mobile user interface and control application for In-Situ water quality instruments. You can use VuSitu on mobile devices with Android operating system 4.4, Bluetooth 2.0 and newer. Download the latest version of the app from the Google Play Store at [play.google.com](https://play.google.com).

VuSitu allows you to accomplish the following tasks.

- View live readings that update every 10 seconds
- Change parameters and units
- Set up a data log
- Record data
- Email data in spreadsheet format
- Download data to mobile device
- Transfer data from mobile device to a computer
- Organize data by Location
- Calibrate Sensors and View Reports

## Connected Instrument Screen

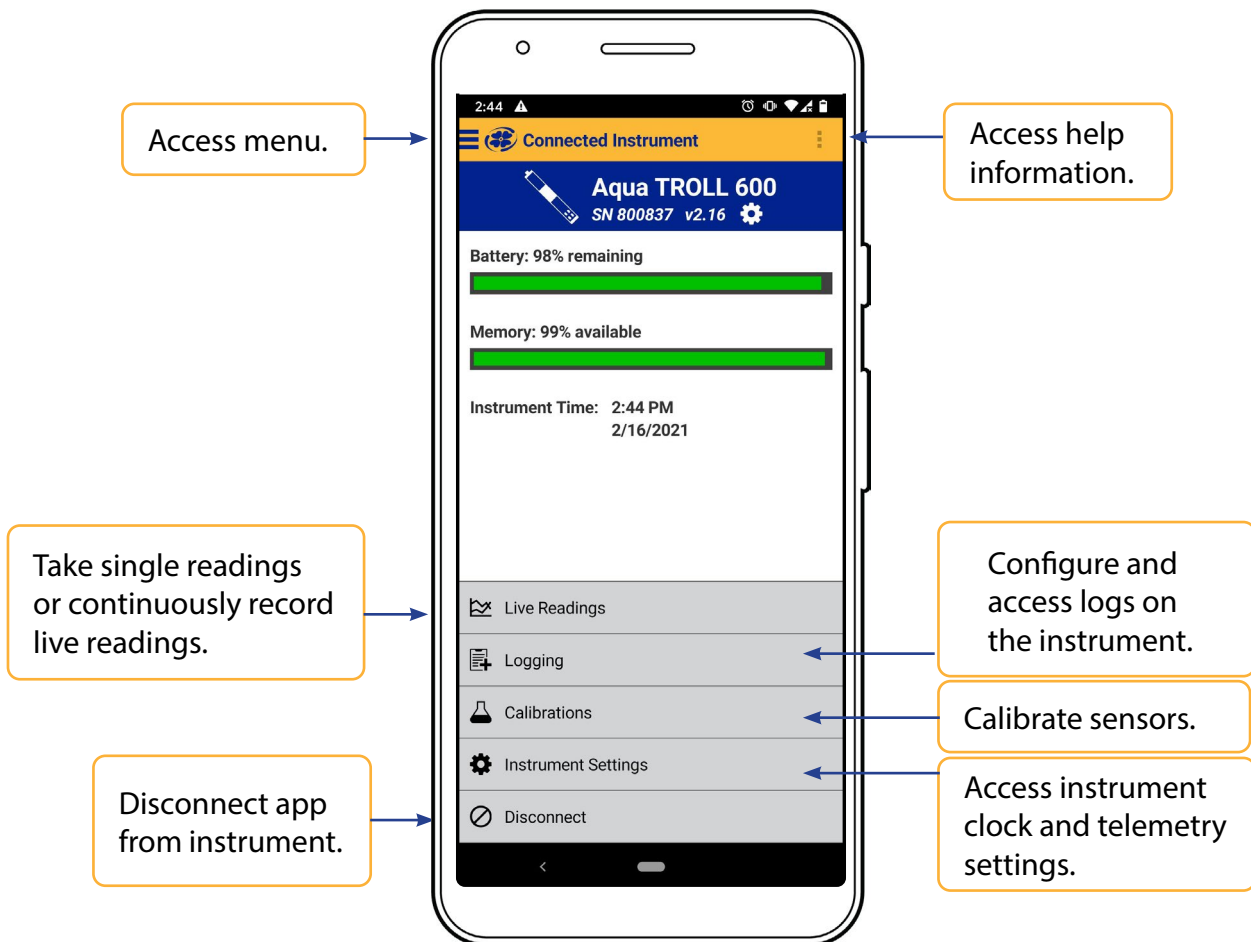

## Live Readings Screen



The live readings screen displays measurements taken from the instrument every two seconds. You can save these readings and share them via email or cloud storage.

## Snapshot Mode

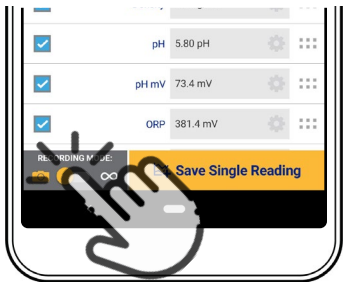

Tap the button on the bottom left to toggle between snapshot and live readings modes.

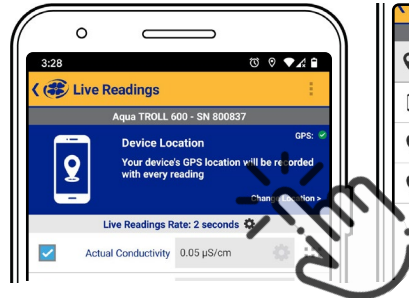

Tap **Change Location** in the top right corner if you wish to associate this data with a different location.

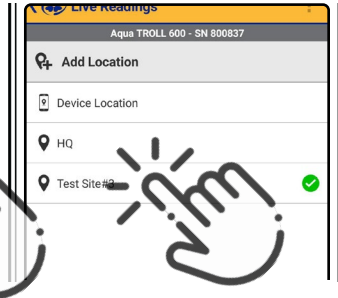

Choose the desired location and press **Save** in the bottom right corner of the screen.

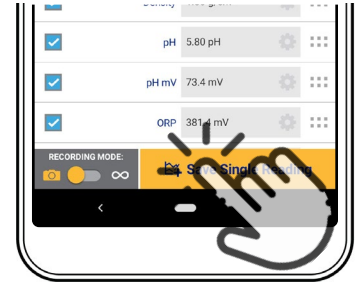

Tap **Save Single Reading** to create a snapshot.

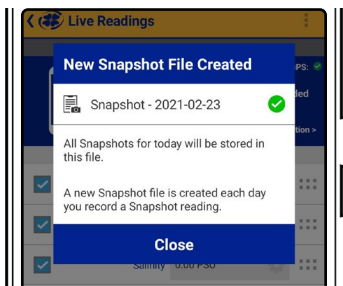

VuSitu confirms the new snapshot file.

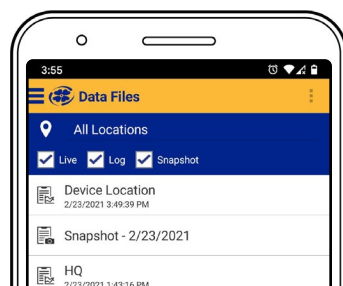

View the file from the Data Files screen.

## Live Readings Mode

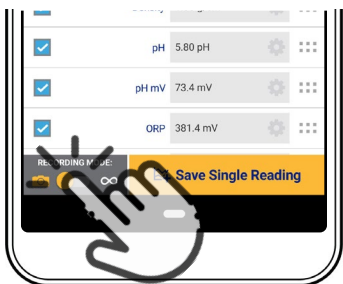

Tap the button on the bottom left to switch from snapshot mode to live readings mode.



Tap **Start Recording**. The instrument takes a reading every two seconds.



Tap **Stop** to end the recording. VuSitu displays a summary of the live readings data.

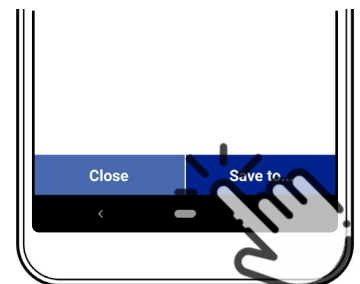

Tap **Save to** if you wish to share the Live Readings file via email or cloud storage.



## Changing Parameters and Units

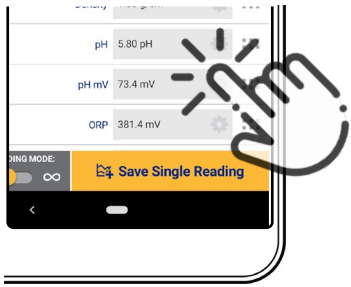

From the Live Readings screen, tap the settings wheel next to the field that contains the measurement value.



Tap the parameter drop-down arrow and tap the parameter you want to display.



Tap the units drop-down arrow and tap the unit you want to display.



Tap the **OK** button to set the options and return to the Live Readings screen.

## Downloading and Sharing Your Data



You can transfer a data file from your mobile device to a PC via Bluetooth, email it to yourself or any valid email address, or upload it to Google Drive.

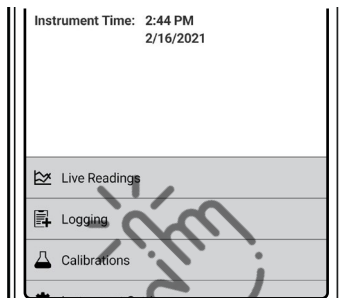

Pair VuSitu with the instrument. Select **Logging** from the Connected Instrument screen.

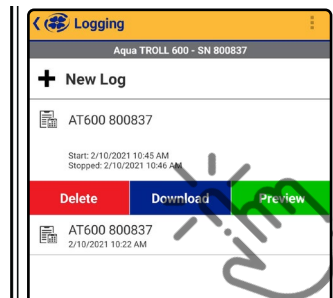

Tap a log and press the **Download** button.

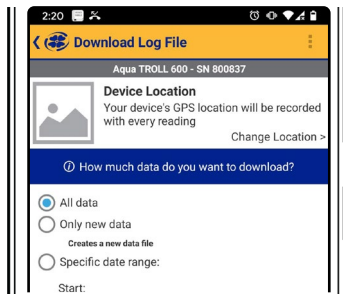

Choose the data you wish to download. To save the entire log to your phone, choose **All data**.

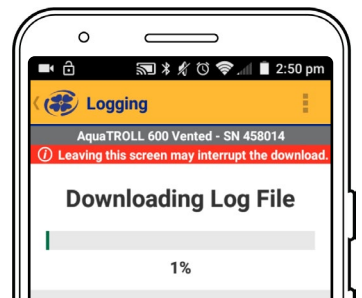

VuSitu displays a progress bar while downloading.

## Sharing Data

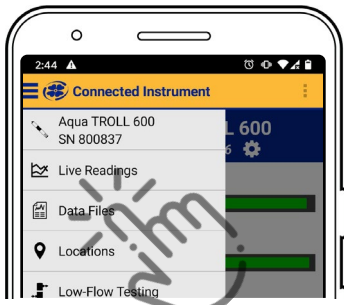

Select **Data Files** from the menu at the top left corner of the screen.

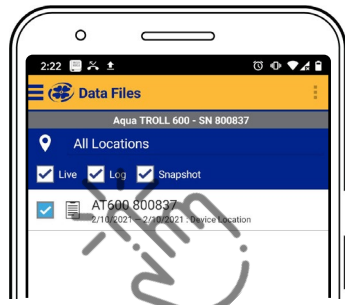

Tap and hold the name of the log you want to share.

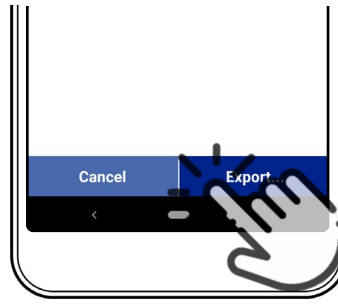

Select **Export**.

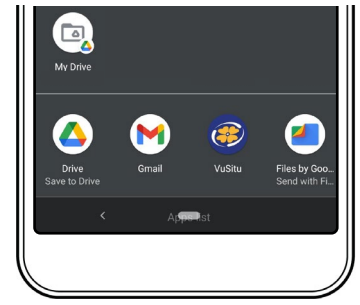

Choose email, cloud storage, or another sharing option.



To save data locally on your mobile device, export to a third-party file management app.

## Viewing Data on a Mac or PC



You'll need to extract your files to view them. To do that on a Mac, double-click the Zip folder. On a PC, right-click on the folder and choose **Extract**. Then open your files in Excel.

# Field deployment

## 1 Program the instrument.

In order to set up a log or download data, you must connect the instrument to a computer running Win-Situ 5 software or to a mobile device with the VuSitu app. See page 52.

## 2 Position the instrument.

Place the instrument at the desired depth. Position the instrument below the lowest anticipated water level, but not so low that the pressure sensor range might be exceeded at the highest anticipated water level. Refer to the tables below to determine usable depth.



A BaroTROLL Instrument can be deployed with a non-vented instrument to compensate level data for changes in atmospheric pressure. Make sure the clocks on both instruments are synchronized, and install the BaroTROLL in a location that will never be submerged in water.

Non-vented Level TROLL instrument

Range	Effective range		Usable depth	
	PSIA	kPA	Meters	Feet
30	15.5	106.9	11	35
100	85.5	589.5	60	197
300	285.5	1968	200	658
500	485.5	3347	341	1120
1000	985.5	6795	693	2273

Vented Level TROLL instrument

Range		Usable depth	
PSIG	kPA	Meters	Feet
5	34.5	3.5	11.5
15	103.4	11	35
30	206.8	21	69
100	689.5	70	231
300	2068	210	692
500	3447	351	1153

### 3 *Verify instrument depth.*

After you have installed the instrument, it is possible to connect the instrument to a computer or mobile device, open the software, and take a reading to verify the installation position. If the reading confirms that the instrument is in the correct position, you can secure it as described below.

During log setup there was an option to “Remind Me Later” for setting a level reference. If you set the log to remind you later, ensure that the instrument is submerged and set the level reference when prompted.

### 4 *Secure the cable.*

The Rugged Cable System includes a Kellems grip near the up-hole end. You can compress the wire mesh and slide the grip to the desired location on the cable. Pull on the grip to tighten it on the cable.

Use the loop on the Kellems grip to anchor the cable to a convenient stationary object such as the In-Situ well dock installation ring. To install the Kellems grip to the installation ring, insert the loop into the locking clip on the well dock and position the assembly at the top of a well casing.

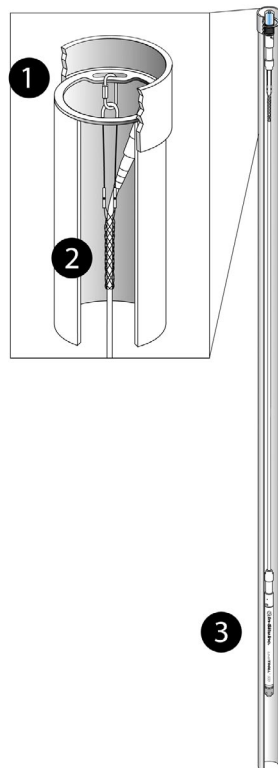

1	Well Dock Installation Ring
2	Kellems Grip
3	Instrument installed in well

## 5 Install the desiccant.



Vented cable must be protected with a desiccant pack that is properly sized for site conditions.

### Desiccant

Desiccant protects cables, connections, and internal components from condensation, which can cause irreparable damage and loss of data. Indicating desiccant changes from blue to pink as it becomes saturated with moisture.

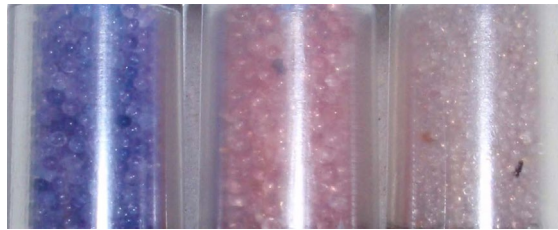

*Desiccant stages (from left)*

*New, nearly expired (replace now), expired*

It is extremely important to use a properly-sized desiccant for your deployment and to change desiccant often. Desiccant should be changed before the entire volume has turned pink, and you should use enough desiccant to effectively keep your equipment dry until your next scheduled maintenance. Desiccant longevity is dependent on site conditions and can vary from one site to the next.

### Installation guidelines

- Never let the instrument fall freely down a well. Doing so will damage the sensor.
- After you have installed the instrument, verify the water level reading. Move the instrument and take another reading to ensure that the instrument shows reasonable change. The instrument could be wedged against the well casing with a loop of cable hanging below. An instrument in such a position could become dislodged and move while it is logging data, which would record a false change in the water level.
- For accurate measurements, the instrument should remain immobile while it is logging data.
- Make sure that the uphole cable end is protected. The vented cable must be protected with a desiccant, and the non-vented cable must be protected with a dust cap. The uphole cable end must be positioned above the highest anticipated water level. Avoid placing this end in a location that might flood.
- Do not deploy instruments in such a way that ice may form on or near the sensor or cable connections. Ice formation is a powerful expansive force that can over-pressurize the sensor or otherwise cause damage. Damage associated with ice formation is not covered by the instrument warranty.
- Do not allow vented cable to bend enough to obstruct the internal vent tube. The recommended bend radius is 13.5 mm (0.54 in), which is twice the cable diameter.

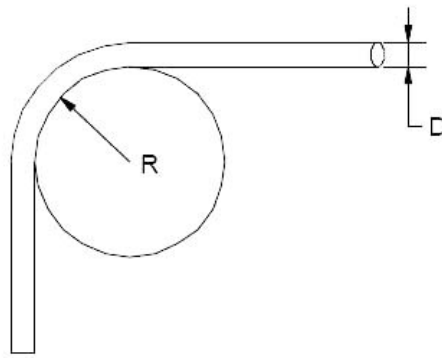

R	Bend radius 13.5 mm (0.54 in)
D	Cable diameter

### Stabilization time

After you have installed the instrument, allow it to stabilize to the environment for about 10 minutes before logging data. The T95 response time for temperature is less than 9 minutes.

A generous stabilization time is always desirable, especially in long-term deployments. Even though the cable is shielded, temperature stabilization, stretching, and relaxing can cause changes to readings.



If you intend to monitor water levels to the instrument's stringent accuracy specifications, allow up to 60 minutes for the probe and cable to stabilize to the environment.

## BaroTROLL Instrument Installation

The BaroTROLL Instrument is designed to log barometric pressure from 0 to 16.5 PSIA (1.14 bar, 33.59 inHg) at the surface near a submerged non-vented Level TROLL Instrument or Aqua TROLL 200 Instrument. BaroTROLL data may then be used to correct the water level data for barometric pressure fluctuations.



### Programming the Baro TROLL instrument

Connect the BaroTROLL to Win-Situ 5 software or the VuSitu mobile app and sync the clock. Set up a log with the same start time and sample interval as you set up in the non-vented level instrument.

### Installation

After the BaroTROLL Instrument is programmed, install it in a protected location above the water level near the submerged water level instrument. One installation configuration option is shown below using a twist-lock hanger and a suspension wire.



To prevent flooding of the BaroTROLL electronics, attach the twist-lock hanger before you install the BaroTROLL. Do not submerge the Baro TROLL Instrument.

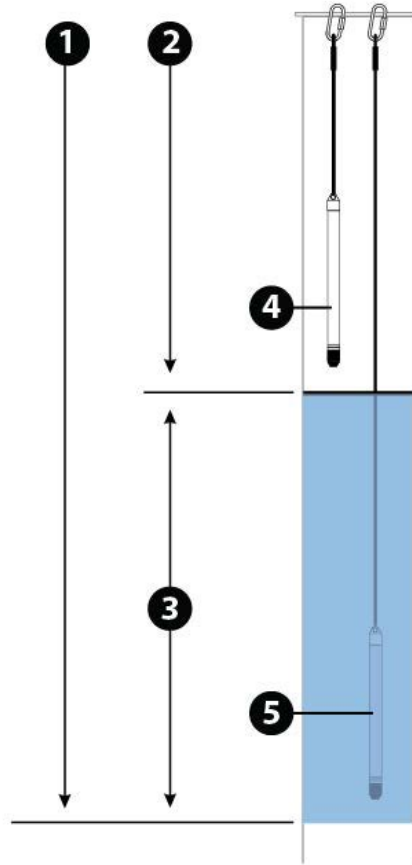

1	Atmospheric pressure + water pressure (as measured by a non-vented pressure sensor)
2	Atmospheric pressure (as measured by the BaroTROLL)
3	Water pressure (as measured by a vented pressure sensor, or by subtracting BaroTROLL data from non-vented pressure sensor data)
4	BaroTROLL Instrument (Do not submerge.)
5	Non-vented Level TROLL Instrument



## Connecting the Level TROLL to a PLC or Data Logger

The Level TROLL may be connected to a controller or logger for communication via:

- Analog 4-20 mA (provides a configurable 4-20 mA current loop output)
- SDI-12
- RS485 Modbus
- RS232 to Modbus (with a customer-supplied converter)

The flying leads cable has a female twist-lock connector on one end to connect with the Level TROLL instrument. The uphole end terminates in wires for connection to a PLC or data logger.

A shorter cable ending in a male twist-lock connector to connect with RuggedCable is also available.

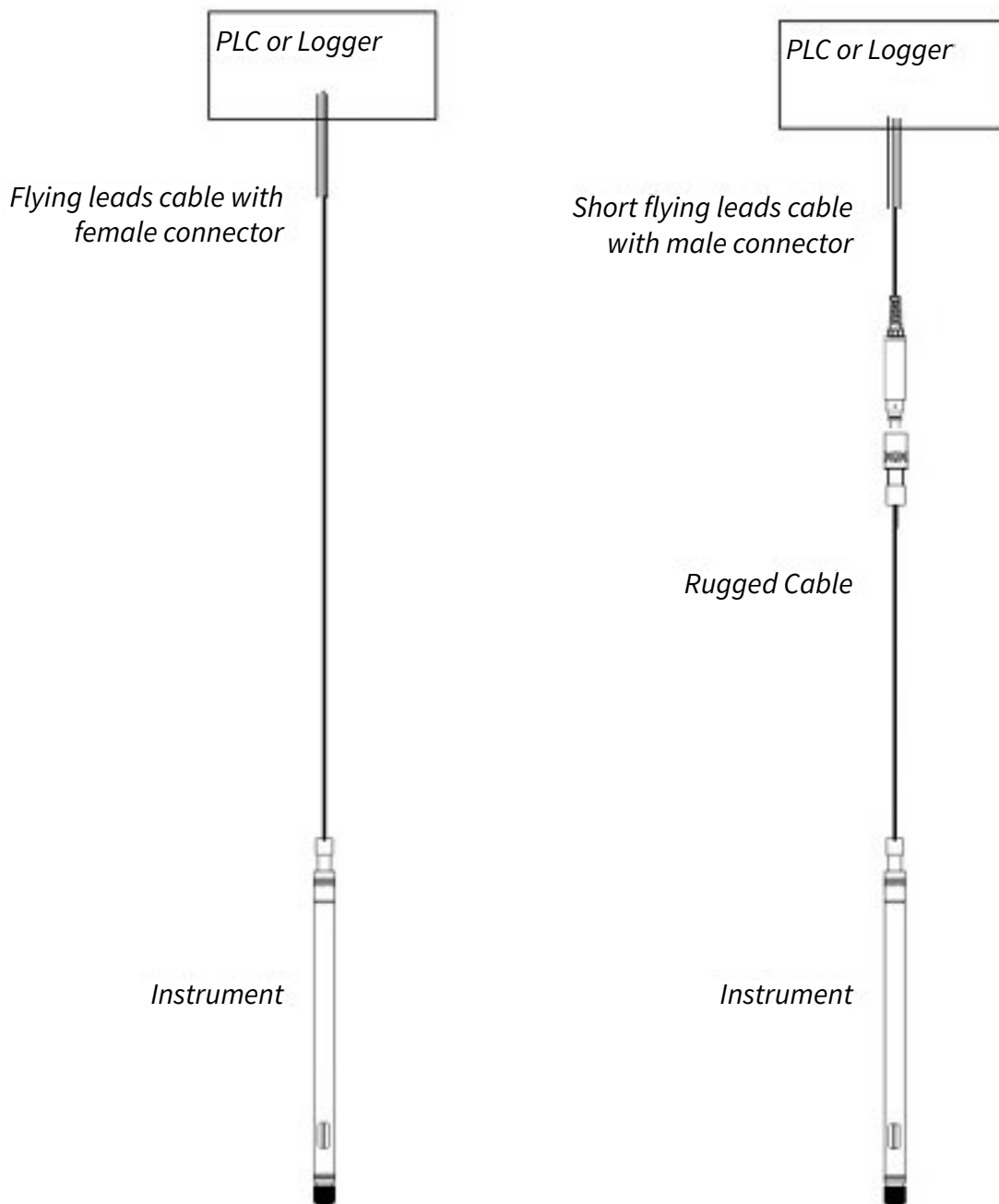

## Flying Leads Wire Diagram



Refer to the diagrams on the following pages for PLC wiring diagrams. Unused leads should not be touching.

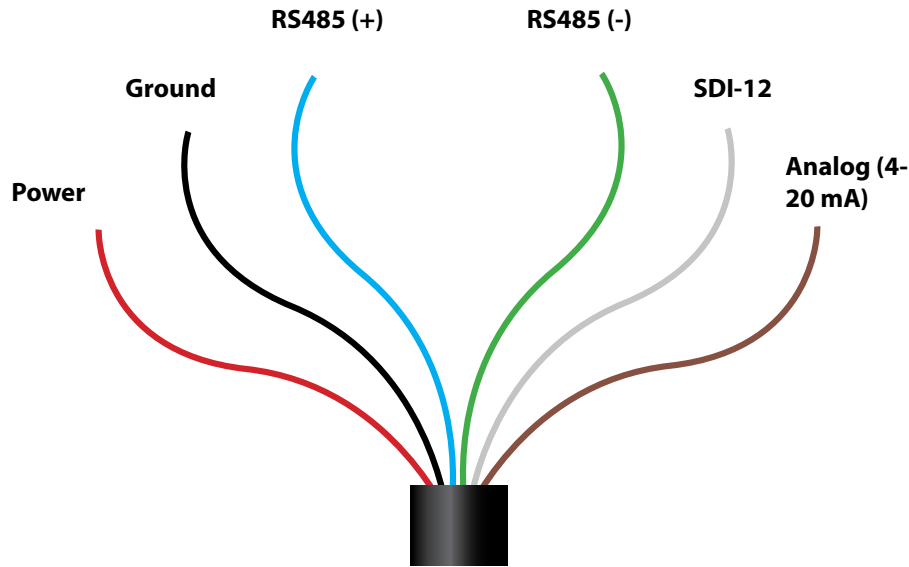

**Flying Leads Cable Wire Legend**

Wire Color	Signal
Red	External Power
Black	Ground/4-20 mA Return
Blue	RS485 (+)
Green	RS485 (-)
White	SDI-12
Brown	Analog 4-20 mA Power

### Desiccant

Vented cable must be installed with outboard desiccant to protect the cable vent tube and Level TROLL electronics from condensation in high-humidity environments.

The desiccant is replaceable and may be temporarily removed from the vent tube during installation.

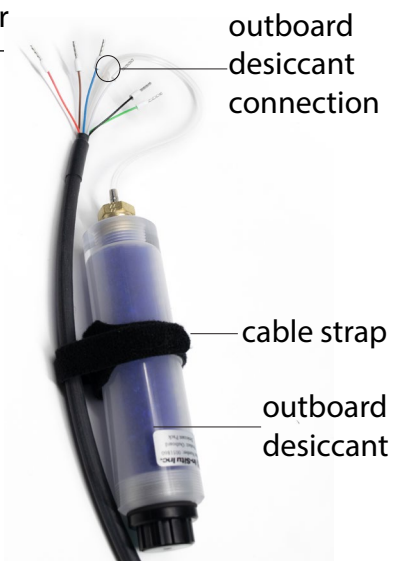

## Power connections

The red wire provides power for Modbus and SDI-12 communication modes. The brown wire provides power for analog communication. If power is present on the brown wire and not on the red wire, the device enters the 4-20 mA mode automatically and stays in the 4-20 mode until power is removed from the brown wire or is applied to the red wire. The red wire has priority. If power is applied to the red and brown wires at the same time, the device will operate in Modbus or SDI-12 modes but not in 4-20.

## Communication modes

The device automatically switches between Modbus and SDI-12 modes depending on which of the two interfaces has activity. Modbus and SDI-12 cannot be used at the same time — whichever one is currently in use will block communication on the other. The 4-20 mA current loop output cannot be used at the same time as Modbus or SDI-12 mode.

## Redundant logging

The Level TROLL can continue recording data to a log while connected to a PLC. If the PLC or recorder loses data or stops recording, the Level TROLL will continue to collect data using its own internal batteries and clock. See the VuSitu section of this manual for more information on setting up a data log on the instrument.

## Analog (4-20 mA) wiring diagram

### Analog (4-20 mA) 2 Wire

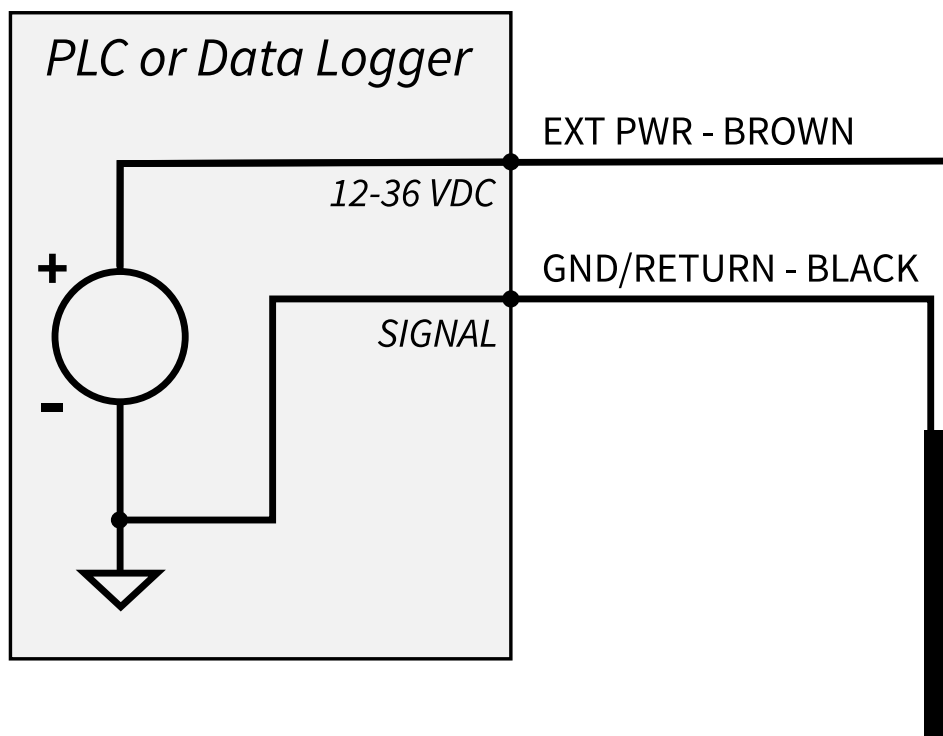

*SDI-12 wiring diagram*

**SDI-12 3 WIRE**

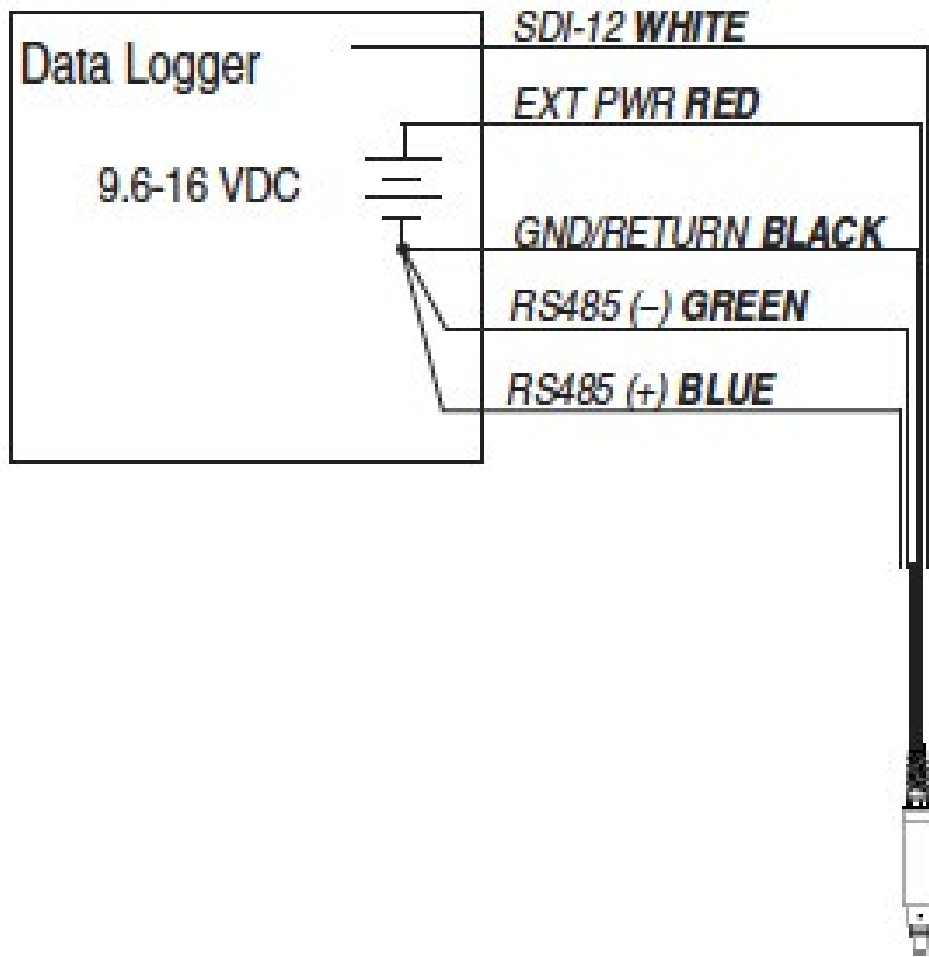

## Modbus (RS485) wiring diagram

### MODBUS MASTER with RS485 built in



# Modbus (RS232 with converter) wiring diagram

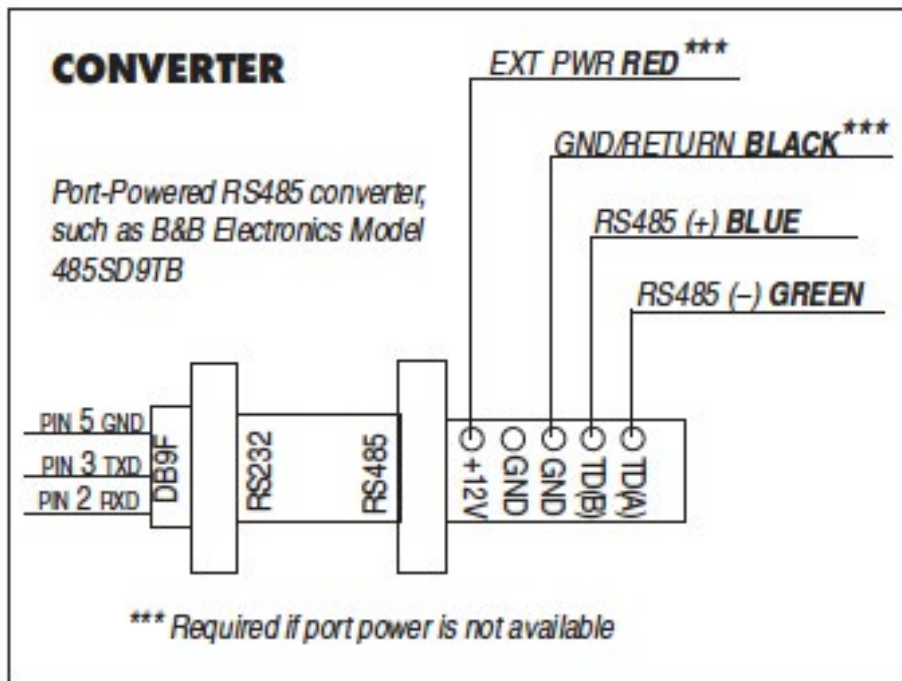
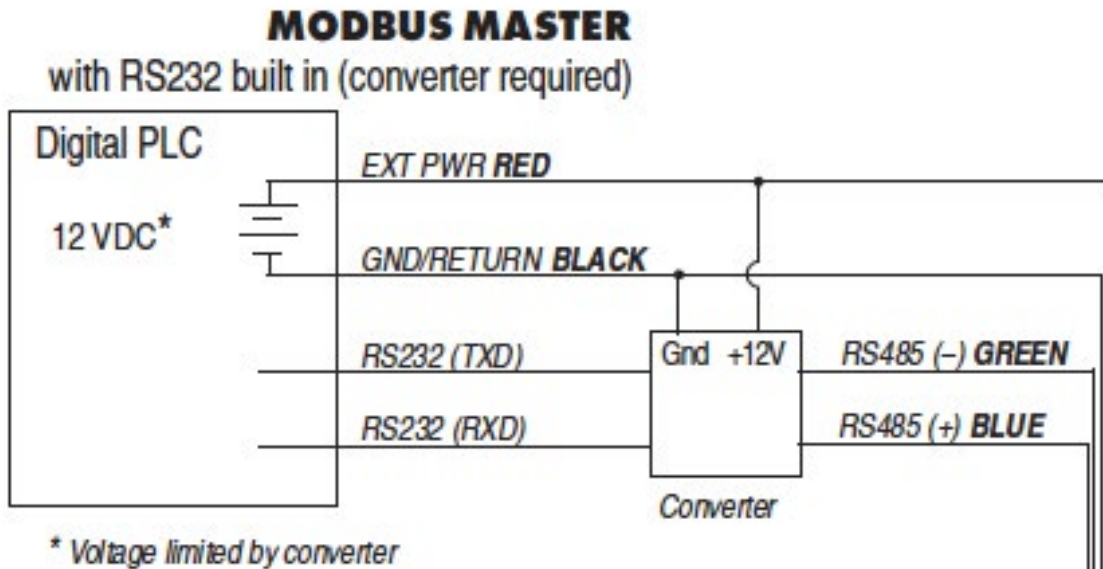

# Configuring SDI-12 Settings

## About SDI-12

You can configure the list of SDI-12 parameters in VuSitu under **Instrument Settings**.

The Level TROLL conforms to the general SDI-12 Standard Version 1.3. For more information about SDI-12 commands, see the SDI-12 Standard Version 1.3 document from the SDI-12 Support Group Technical Committee.

## Configure SDI-12 Settings in VuSitu

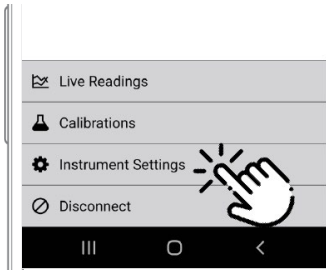

Connect to VuSitu and select **Instrument Settings**.

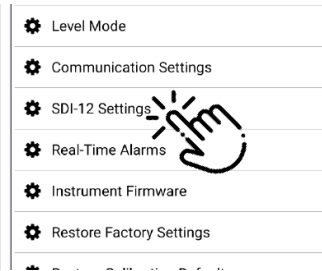

Choose **SDI-12 Settings**.

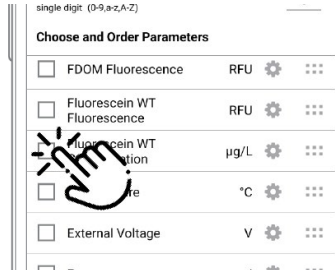

Use the checkboxes to select parameters to display.

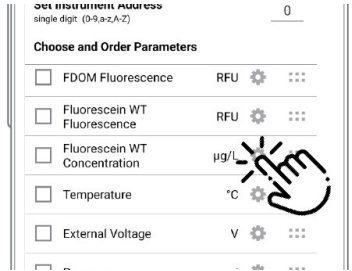

Tap the gear icon to adjust the units for each parameter.

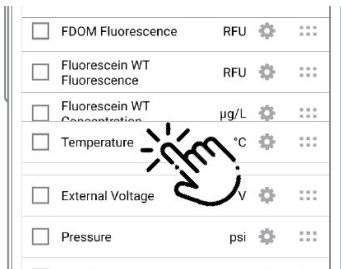

Drag and drop parameters to change the order.

# Modbus PLC Interface

## Overview

The Modbus PLC Interface is a simplified method of communicating with the Level TROLL using the Modbus protocol. For information about the specific Modbus registers and Unit IDs for your Level TROLL, see Appendices A and B. The Level TROLL conforms to the Modbus standard. For more information about Modbus communication, see [www.modbus.org](http://www.modbus.org).

## Setting Up Instrument

1. Connect power, and wire the instrument.
2. The setup below is using the instrument's factory default settings. Use VuSitu to reset the instrument to factory defaults if they have been changed. Take note of any changes in default units setup.

## Programming the PLC

1. Set up the serial communication to match the instrument communication settings. Communication settings can be changed with the VuSitu mobile app. The default communication settings are:

Mode	Start Bit	Baud Rate	Data Bits	Parity	Stop Bit
RTU	1	19200	8	Even	1

2. Set the device address match the instrument address. The default device address is 1.
3. Set the PLC to wake-up the device by sending a carriage return (0x0D) or any Modbus command.
  - a. Allow one second before sending a second command. The instrument needs this time to wake up.
  - b. After the wake-up command, the next reading must be taken before the end of session timeout. If the reading interval exceeds the end of session timeout, send a new wake-up command before requesting a new reading. The default end of session timeout is 5 seconds, and may be longer if the instrument has been connected to VuSitu.
4. Select the register to read on the PLC using the information in the following sections.
  - a. Some PLC devices use the register number directly in programming statements, others use register addresses, which are one less than the register number. Refer to PLC manufacturer instructions to determine which programming style to use.
  - b. Each register is a holding register. Some PLCs require you to add 40000 to the register number or address. For example: 5451 would be 45451.
5. Set the type of register to: 32-bit float
  - a. If asked by the PLC this is 2 registers
6. Set the byte order to: Big Endian (MSB)
  - a. This should be the default and may not be configurable on all PLCs

## Reading Device Information

Use the following registers to read general information about the instrument.

Holding Register Number	Holding Register Address	Size (Registers)	Data Type	Description
9001	9000	1	uint16	Device Id: 30 = Level TROLL 400 1 = Level TROLL 500 2 = Level TROLL 700/700H 3 = Baro TROLL
9002	9001	2	uint32	Serial Number
9007	9006	1	uint16	Firmware version (100 = 1.00)



## Reading Parameters

Each parameter contains a block of 7 registers as shown in the table below. To read measurements for a specific parameter, look up the starting register for that parameter from the list of Parameter Numbers and Locations in Appendix A. Once you have the starting register, add the number of offset registers for additional information about the reading.

Register Offset	Size (Registers)	Mode (R/W)	Data Type	Description
0	2	R	float	The measured value from sensor
2	1	R	uint16	Data Quality ID: 0 = No errors or warnings 3 = Error reading parameter 5 = RDO Cap expired For additional errors or information, contact technical support.
3	1	R/W	uint16	Units ID for this parameter. See: Appendix B.
4	1	R	uint16	Parameter ID for this parameter. See: Appendix A.
5	2	R/W	float	Off line sentinel value: The value that's returned on error or if the parameter isn't available. The default sentinel is 0.0

For example, you can apply this information to collect a reading for Pressure.

From the list in Appendix A, you can find that the starting register for Pressure is 0038. A reading from register number 0038 (register address 0037) will return the measured value of Pressure

Some PLC devices use the register number directly in programming statements, others use register addresses. Refer to PLC manufacturer instructions to determine which programming style to use.

You can use the register offsets listed in the table above to collect additional information about the reading. Adding the register offset of 2 to the starting register, you can find that register number 0040 (register address 0039) will return the Data Quality ID for the most recent Pressure measurement. Likewise, register number 0041 (register address 0040) will return the Units ID, which can be interpreted from Appendix B. Register number 0042 (register address 0041) will return the Parameter ID, which can be interpreted from Appendix A. Register number 0043 (register address 0042) will return the sentinel value.





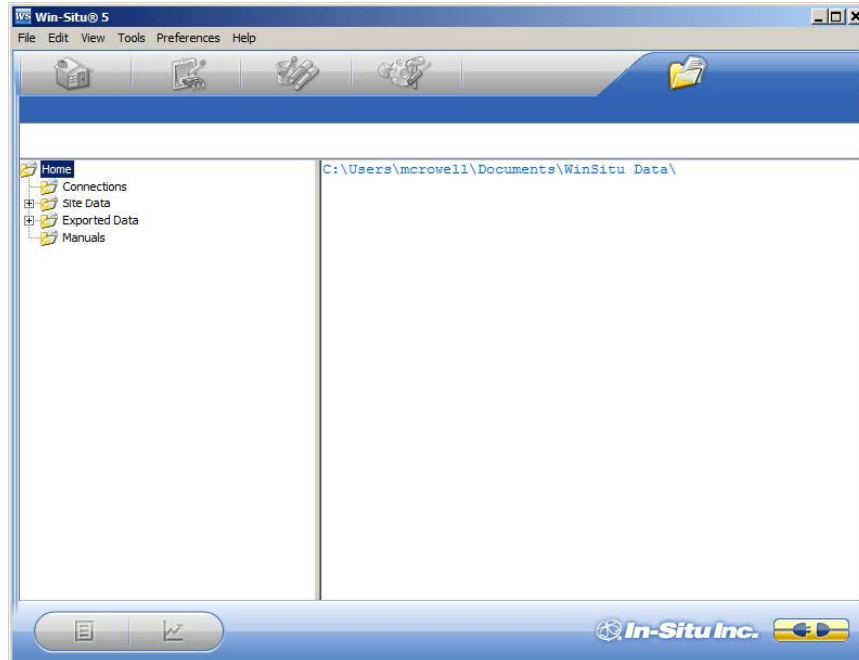

The Units ID and Sentinel Value are writable registers. Measurements can be changed to other units using the Units ID as shown in Appendix B. For example, if register number 0041 (Pressure Units ID) returns 17, Pressure is configured to report in psi. Looking at Appendix B, you can find that kPa is also a valid unit which can be set by writing Units ID 19 to register number 0041.

# Win-Situ overview

## Data tab

When you open Win-Situ 5 Software, the Data tab appears. The left side of the screen contains a file tree where you can view previously downloaded site data as well as data you have exported to Microsoft Office Excel. The links on the right side of the screen show where downloaded data are stored on your computer. The disconnected plug icon in the lower-right corner of the screen indicates that the software is not yet communicating with an instrument.





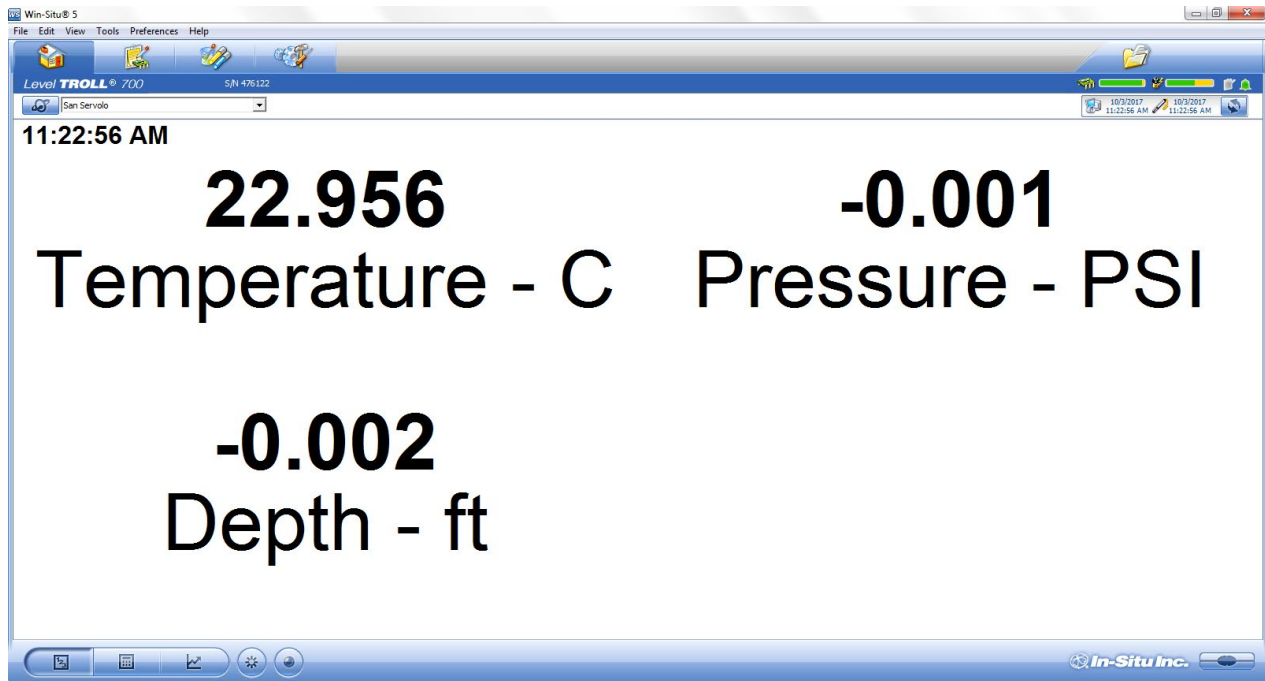

Screen element	Definition
	The disconnected plug indicates the instrument is not communicating with the software. Click to establish communication with a connected instrument.
	The connected plug indicates the instrument is communicating with the software. Click to disconnect the software from the instrument.
	The Home tab displays real-time readings from the instrument. When connection to the instrument is first established, the software displays one reading of all available parameters in light gray. You must click the Play button at the bottom of the screen to view real-time readings.
	The Logging tab displays a list of logs stored in the connected instrument. When you click the Logging tab, it can take a moment for the software to retrieve information from the instrument. (Not applicable for the RDO PRO-X and the Aqua TROLL 400.)
	The Sensors tab lists the sensors in the connected instrument, along with their serial numbers and the dates of factory calibration and user calibration. Use the buttons in this tab to calibrate sensors that support user calibration and configure sensors that are supported by the instrument.
	The Device Setup tab allows access to instrument information and settings such as instrument name, serial number, firmware version, communication settings, diagnostics, and factory reset options.

## Home tab

The Home tab displays real-time readings from a connected instrument. When you first establish communication, the software displays one reading of all available parameters.



Screen element	Definition
	The Sites button allows you to add, edit, or delete a site. Click the drop-down arrow next to the button to view the list of sites.
	The Device Memory gauge turns yellow when the internal memory is used. Note: Non-logging instruments do not have internal memory, however, the gauge shows 100 percent green when power is applied.
	The Device Battery gauge turns yellow as the battery is depleted. This example shows 80 percent of the battery remaining (green) and 20 percent used (yellow). Note: Non-logging instruments do not have internal batteries, however, the gauge shows 100 percent green when power is applied.
	The Logging Status icon: Green—The instrument is actively logging data. Gray—The instrument has no logs pending or running. Non-logging instruments always show a gray status icon. Yellow—The instrument has log data that was collected according to specific instructions in the “Pending” or “Suspended” state.

	<p>The Alarm icon provides additional instrument status information.</p> <p>Green—No alarms or warnings  Yellow—One or more warnings  Red—One or more alarms</p> <p>Move the cursor over the alarm icon to view a description. Click the Device Setup tab for detailed information on the alarm or warning.</p> <p>Note: Disregard the Device Reset alarm for non-logging instruments such as the RDO PRO Probe or the Aqua TROLL 400.</p>
	<p>System Time is displayed on the left. Device Time is displayed on the right. Clocks are updated once every two seconds. When the Device Time is displayed in red, it differs from the current System Time, and should be synchronized.</p>
	<p>The Time Sync button is used to write the current PC time to the instrument. If you need to set the instrument clock to a time other than the system (PC) time, use the Set Clock button on the Device Setup tab.</p>
	<p>Meter View shows the last known parameter values, displayed with current units and time stamp. Readings are sized to occupy the entire screen. This is the default display in the Home tab. If the type is black, the readings are updating in real time.</p>
	<p>List View is a running list of the most recent records. New readings are continuously added to the top of the list and old readings scroll off the bottom.</p>
	<p>Graph View shows a real-time trend graph of the selected parameters.</p>
	<p>The Snapshot button records one set of readings.</p>
	<p>The Record button logs data to a CSV file that can be opened in a spreadsheet program. This is not the same as recording data in a log on the instrument.</p>

## Logging tab

The Logging tab displays a list of logs in the instrument. When you click the Logging tab, it may take a moment for the software to retrieve information from the instrument.

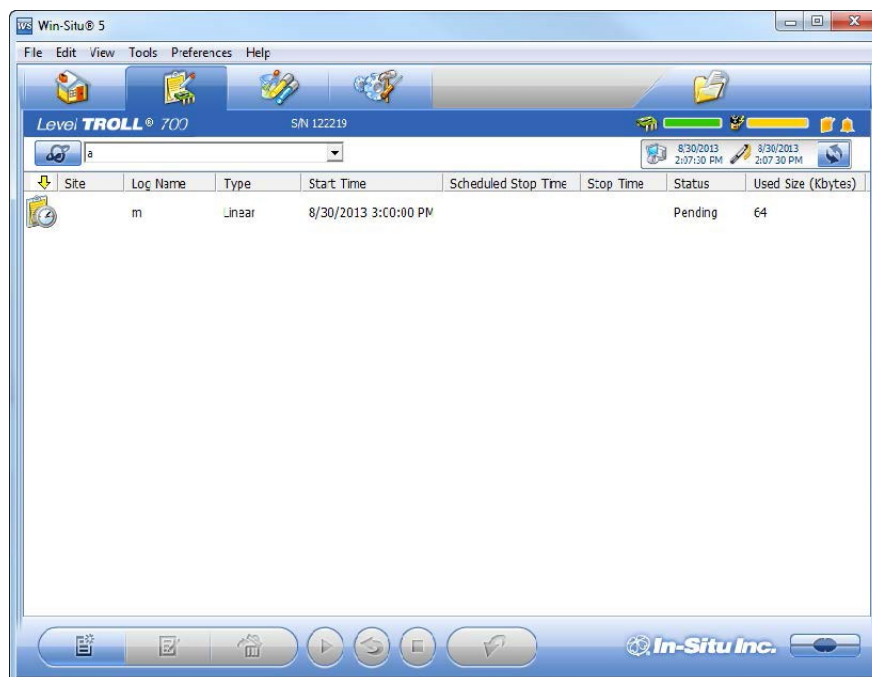







## Log information

Columns across the Logging screen show information about the logs in the instrument.

- **Symbol**—This is a graphic representation of the information in the Status column.
- **Site**—The site that was specified when the log was configured.
- **Log Name**—The name that was entered when the log was configured.
- **Type**—The logging method that was selected when the log was configured.
- **Start Time**—For a Pending log, the scheduled start time is shown. For a Ready log that has not yet started, this column displays “Manual.” For a Running or Stopped log, the actual start time is shown.
- **Scheduled Stop Time**—For a log with a scheduled stop, the scheduled stop time is shown. For a log without a scheduled stop time, this column is blank.
- **Stop Time**—For a Pending or Ready log, this column is blank. For a Running log, the time of the last data point is shown. For a Stopped log, the actual stop time is shown.
- **Status**—Each log has a specific status. See Log Status for details.
- **Used Size**—Kilobytes of instrument memory allocated for this log. For a Pending or Ready log, the current size of the log configuration is shown. For a Completed log, the size of the entire log file is shown. For a Running log, the current size of the log up to the last data point is shown.

## Log status

The status of each log in the instrument is displayed in the Logging tab by a symbol beside the log name, and in the Status column.





-  Ready—Manual Start log is ready to start.
-  Pending—Scheduled start log is ready to start at its programmed time, or when you click the Start button.
-  Running—The log is actively logging data.
-  Suspended—The log has been paused (stopped temporarily).
-  Stopped—The log has been stopped, either manually or on a schedule.
-  Deleted—The log has been marked for deletion and will be deleted from the instrument when memory is needed. The software manages this automatically.
-  Invalid—The log as programmed cannot be run.



Ready, Pending, Running, and Suspended logs are considered active. Only one log can be active in the instrument.

## Log control buttons

You can control the status of a log by selecting the log and clicking the appropriate button in the Logging tab control panel:



-  The Start button starts a Ready or Pending log, or resumes a Suspended log.
-  The Pause button pauses a Running log allowing you the option to resume it.
-  The Restart button restarts the selected Running log from the beginning. This can be useful during aquifer testing using a logarithmic data collection schedule.
-  The Stop button permanently stops the selected Running log.

## Log operations

Use the buttons in the control panel to perform the following actions:

-  Create a new log.

The New button is disabled if a Ready, Pending, Running, or Suspended log is on the instrument. When the instrument contains its maximum number of logs, the New button is unavailable.

-  Edit (or review) the log configuration for a Ready, Pending, or Invalid log.
-  Delete the log. (Note that you must delete a log twice before it is permanently removed.)
-  Download the log to a PC.

## Sensors tab

The Sensors tab lists the sensors in the instrument, along with their serial numbers and calibration dates. Use the buttons in this tab to calibrate and configure sensors.

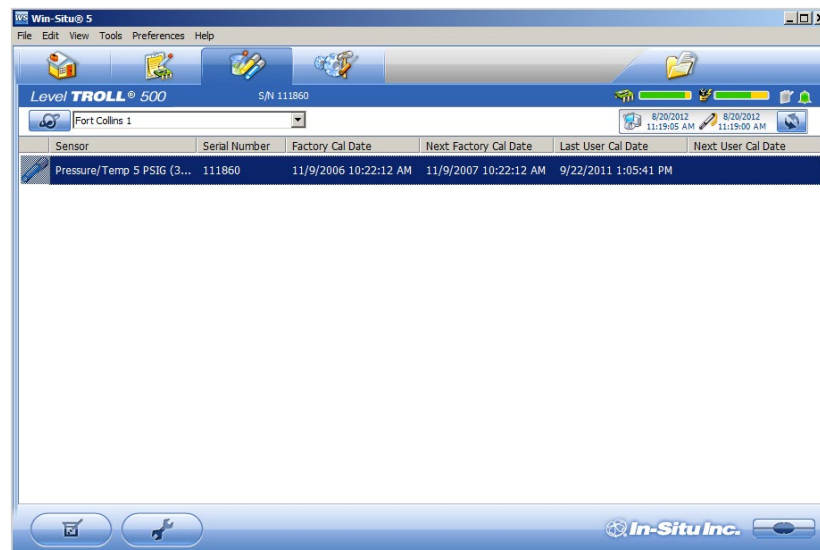

## Calibrate

Use the Calibration button to calibrate sensors or to adjust a level reference that is currently stored on the instrument. The Calibrate button is not available when the instrument does not support calibration (e.g. BaroTROLL Instrument).

1. With the instrument connected to the software, select the Sensors tab.
2. Select the parameter you intend to calibrate.
3. Click the Calibrate button

## Configure

Use the Configure button to select parameter units and to configure parameters that support configuration. Examples include Level/Depth, Specific Conductivity, and Total Dissolved Solids. Parameters cannot be configured while the instrument is showing live data on the Home screen or while the instrument contains an active log.

1. With the instrument connected to the software, select the Sensors tab.
2. Select the parameter you intend to configure.
3. Click the Configure button



When you configure the Level parameter using the Sensors tab, the settings are stored in the instrument and are available for use in Modbus, SDI-12, or analog communication (if available). If desired, a different configuration can be selected when setting up a log.

## Device setup tab

In general, you should not use the Device Setup tab unless you are corresponding with the In-Situ technical support team. However, you can use this screen to set up communication protocols if you are connecting the instrument to a PLC or data logger.

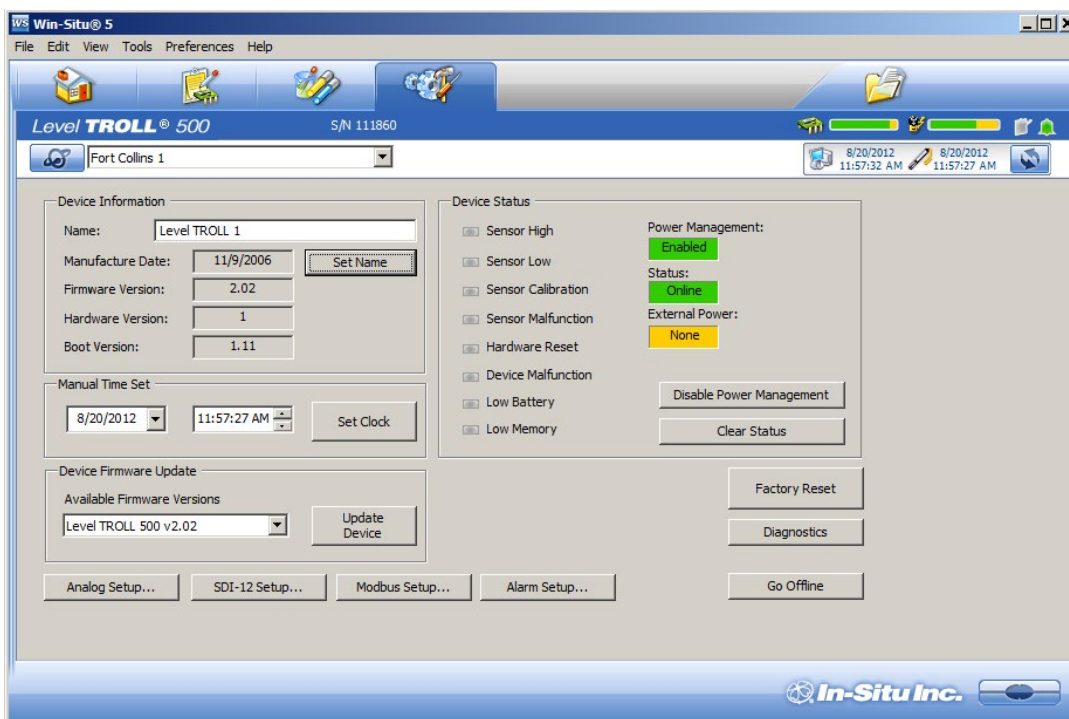

## Using Win-Situ 5 software

### Connecting an Instrument to the Software

When you open Win-Situ 5 Software, you are asked if you want to connect to your device. Click Yes. Synchronize the instrument clock to the PC clock.

The software displays an error message if a connection cannot be established.

### Selecting the correct COM port

If you are using a USB TROLL Com, select the correct COM port by following the steps below. If you are using a serial TROLL Com, the Win-Situ Software should default to the correct COM port, which is usually COM 1.

#### Steps for Windows 8.1 and Windows 10 systems.

1. Right-click the Start button.
2. Click Device Manager.
3. Click the arrow next to Ports (COM and LPT), and locate the USB Serial Port listing. The number listed next to this entry is your COM port address.

#### Steps for Windows 8 systems.

1. Right-click the Start screen.
2. Select All Apps.
3. Click Control Panel.
4. Open the Device Manager.
5. Click the arrow next to Ports (Com and LPT), and locate the USB Serial Port listing. The number listed next to this entry is your COM port address.

#### Steps for Windows 7 systems.

1. Click the Start button, and open the Control Panel.
2. Click Hardware and Sound, and open the Device Manager.
3. Click the arrow next to Ports (COM and LPT), and locate the USB Serial Port listing. The number listed next to this entry is your COM port address.

#### Steps for Windows XP systems.

1. Click the Start button, and open the Control Panel.
2. Double-click the System icon. Click the Hardware tab, and open the Device Manager.
3. Click the plus sign next to Ports (COM and LPT), and locate the USB Serial Port listing. The number listed next to this entry is your COM port address.



The following steps apply for all Windows operating systems.

1. Once you have determined the correct COM port address in your operating system, reopen Win-Situ 5 Software.
2. Close any open windows in Win-Situ Software.
3. Click Preferences.
4. Click Comm Settings, and then click the Port Number menu.
5. Scroll down to find the correct COM port address. Click the check mark to accept the changes.
6. Click the yellow Connect button in the lower right corner to establish a connection to the instrument.



## Bluetooth & Wireless TROLL Com

Connect the cable to the Wireless TROLL Com and the Level TROLL instrument. Turn on the Wireless TROLL Com and open Win-Situ 5. Choose File > Connect to access the Default Communication Settings window.

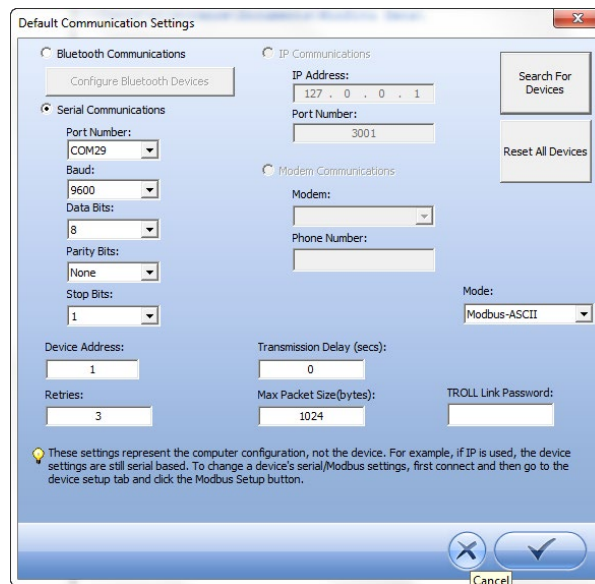

Select the radio button labeled Bluetooth Communications and click Configure Bluetooth Devices. You will see a list of nearby Bluetooth devices. Click the Wireless TROLL Com you are using and click the check mark.

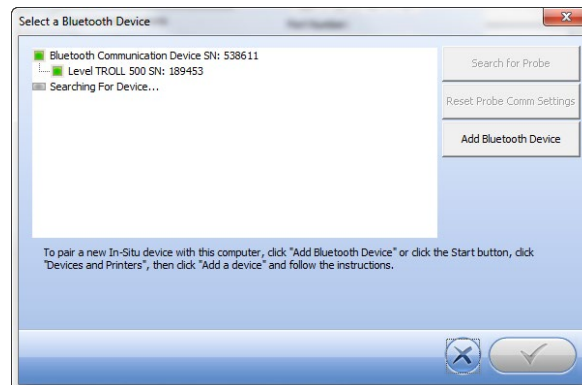

Finally, click the yellow Connect button at the bottom right of the screen to complete the connection.

### Setting the instrument time

The instrument time and the current PC time are shown at the top of the screen when an instrument is connected to the software.

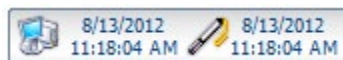

The PC time appears on the left, the instrument time on the right. Both clocks are updated at 0.5 Hz (once every two seconds). The device time is displayed in red if it differs by more than a few seconds from the current PC time. Data logging schedules depend on a correct instrument time.

To synchronize the instrument time to the current PC time, click the Clock Sync button Win-Situ writes the current PC time to the instrument.

## Adding a new site

To add a new site to the site database in your working directory do one of the following:

On the Data tab, click the Site Data folder, select File> New > Site.

or



On the Home tab, click the Site button to display the site list, then click New . Enter a name for the site. This is the only required field.

Click Save to save the new site. The new site will appear in the Site Data folder, and Win-Situ will add it to the site database in the working directory on your computer. It is now available to select for any instrument log.

## Log setup

The Log Setup Wizard presents sequential screens to help you supply all the information necessary to set up a data log in the instrument.

To access the Log Setup Wizard the instrument must be connected to the software.

1. Click the Logging tab. 
2. Click the New button. 
3. Select the Site where the set of data will be logged and supply a name for the log.
4. Click the right arrow to continue after each step.
5. Select the parameters you intend to measure, choose the measurement units, and specify the order in which the selected parameters will be logged.
6. Select the logging method you intend to use.
7. Select the log interval. A log interval is how often a measurement will be taken and stored.
8. Select the start condition, stop condition, and specify how to handle full device memory.
9. If you selected Level or Depth as a parameter to measure, specify how you intend to log this parameter.
10. The final screen summarizes the log setup. Click the check mark to write this information to the instrument.

## Logging method descriptions

The following is a list of log types and their descriptions. The log types that are available on an instrument vary depending upon the capabilities of the instrument.

### Logging methods for long-term monitoring

#### Linear

Linear log type measures and records at a user-defined fixed interval of one minute or more.

This method is used for long-term studies, landfill monitoring, stream gauging, tidal studies, and background monitoring prior to aquifer testing. Intervals are measured in days, hours, or minutes.

## Linear Average

Linear Average log type can smooth out anomalous highs and lows that may occur in a data set, for example, when a water wave passes over the instrument. Each stored measurement is the average of several rapid measurements. This method is used for long-term studies, stream gauging, tidal and open-water studies where trends are more important than accuracy. Intervals are measured in days, hours, minutes, or seconds.

## Event

Linear Event log type combines basic fixed-interval logging of specified parameters with the ability to log data at a faster interval when a single-parameter event condition is present.

## Logging methods for long-term monitoring

### True Logarithmic

True Logarithmic log type captures early-time water-level data during aquifer testing. Measurements are very closely spaced at the start of the test (4 measurements per second) and move further apart on a logarithmically decaying schedule as the test progresses. There are 40 measurements per log decade. This log type is commonly used for rapid step-drawdown pump tests, constant-rate pump tests, and slug tests.

### Fast Linear

Fast Linear log type measures and records at a user-defined fixed interval of one minute or less. The interval is small

(seconds, milliseconds), and the test is usually of short duration due to the volume of data logged and the impact of very fast sampling on battery life.

### Step Linear

Step Linear log type measures and records data according to a number of user-defined elapsed time intervals or “steps” within a schedule. Both the elapsed time and the number of measurements within each step can vary. After completing the elapsed time for each step, the schedule will automatically move to the next step. Up to 10 separate steps can be defined.

## About the level reference

A Level Reference, also called an offset, is a user-specified starting point for logged Level readings. Depth mode does not require that you enter a Level Reference.

The Level Reference can be any value you choose. Here are some examples:

- **Elevation**—If you calculate the water level above mean sea level (MSL) and enter this as the Level Reference, then elevations above MSL will be logged.
- **Depth to Water**—If you measure the depth to the water surface (DTW) from the top of the well casing and enter this as the Level Reference, then DTW (also called drawdown) values will be logged.
- **Zero**—A Level Reference of 0 effectively sets the probe to zero at the start of the log. Changes, both positive and negative, from the starting water level, will be logged.

Once you have determined the value of your Level Reference, the software gives you three options for entering it. These control when the level reference is applied.

- **New Reference**—This option is designed to be used with an active software connection when the device is installed in the water.



A new level reference must be entered while the device's pressure sensor is submerged in its final position in the water. This is because the current probe reading is set equal to the Level Reference to create the offset that takes effect at the start of the data log. The log header will show the probe reading at the time you entered the Level Reference.

During log setup, the software presents two additional options for entering the Level Reference:

- Set first logged reading—Use this option when the instrument will be deployed on wire rather than cable because you will not be able to communicate with the instrument when it is submerged.
- Remind me to set reference later—Use this option to defer the entry of the Level Reference during log setup and set a reminder to enter it when the device is submerged in its final position.

## Starting a log

Every log is programmed for either a manual or a scheduled start. A log with a manual start time is displayed in the Logging screen with Ready in the Status column. A log with a scheduled start time is displayed with Pending in the Status column.

### Starting a Pending Log

A Pending log automatically starts at the scheduled time without any user intervention.



A scheduled log with Pending status can be manually started at any time before its scheduled start.

### Starting a manual log

1. With the instrument connected to the software, select the Logging tab.
2. Select the Ready log you want to start.
3. Click the **Start Log** button. The log starts and the symbol changes. The Status column displays Running.

### Suspending (pausing) a log

A running log may be temporarily paused. For example, you might want to reposition an instrument, calibrate a sensor, or clean a sensor and later resume the log. A log can be suspended and resumed three times.

1. With the instrument connected to the software, select the **Logging** tab.
2. Select the log you intend to suspend.
3. Click the **Suspend** button. Suspended appears in the Status column.

### Resuming a suspended log

1. To resume logging after a log has been suspended, select the Logging tab.
2. Select the Suspended log.
3. Click the Start Log button. Logging resumes. Running appears in the Status column. The data file will show the time when the log was suspended and the time when it restarted.

## Stopping a log

A log can be manually stopped at any time, even if a stop time has been previously scheduled. If you did not specify a stop condition when you defined the log, the log will run until the instrument is out of memory or battery power, or until you manually stop it.



A log that has been stopped cannot be resumed. If you intend to resume a log later, you should suspend a log rather than stop it.

1. To manually stop a log, the instrument must be connected to the software.
2. Select the Logging tab.
3. Select the running log you intend to stop.
4. Click the Stop Log button.

### Downloading data to a PC

This procedure copies the data log from the instrument to a PC. It does not remove the data log from the instrument. After a log is downloaded, it can be exported to a CSV file format that can be used by spreadsheet programs. The time shown in the log name is the time the log was downloaded.

1. With an instrument connected, select the Logging tab
2. Select the log you intend to download.
3. Choose a Running, Suspended, Stopped, or Deleted log.
4. Click the **Download** button.
5. In the next screen, select one of the three download options.
  - All data
  - New data (data logged since the last download)
  - Time interval to download



New data is downloaded by default to a new log file. To append new data to the last download of this log, be sure the option "Append logs on download" is selected in the General Settings dialog (Preferences > General Settings).

1. The log is copied to the connected PC into your Win-Situ working directory folder. View or change the working directory using **File > Settings**.
2. At the end of the download, Win-Situ gives you the option of viewing the data.
3. Select **Yes** and the log is displayed in the Data screen.
4. Select **No** and the Logging screen appears. You can view the data at any time by selecting it in the Data tab.

### Viewing logged data

1. To view the data stored in the instrument, you must first download the data. A connection to an instrument is not needed after the data log has been downloaded.
2. Select the Data tab.
3. On the left side of the screen, select the log you want to view. To expand a folder shown in the navigation tree, double-click the folder. The content of the data log is displayed on the right side of the screen in text or graph format.



To switch between view formats, click the Text or the Graph button in the control panel. To customize the text or graph view, select Preferences > Graph Settings or Preferences > Data View Settings. These options apply to all downloaded data until you change the options.

## Importing VuSitu data to Win-Situ

You can import data files from VuSitu into Win-Situ 5 from the File menu.

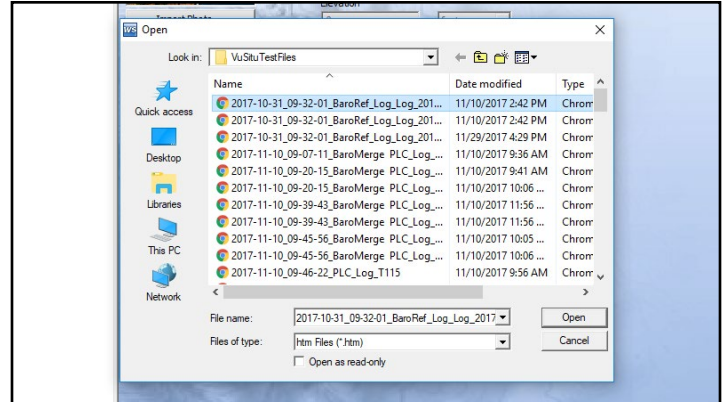
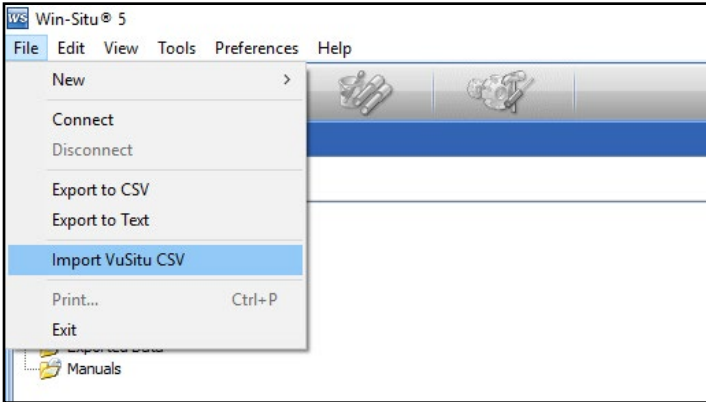

Click File > Import VuSitu CSV in the menu bar at the top of the screen.

Select the file you wish to import and click Open.

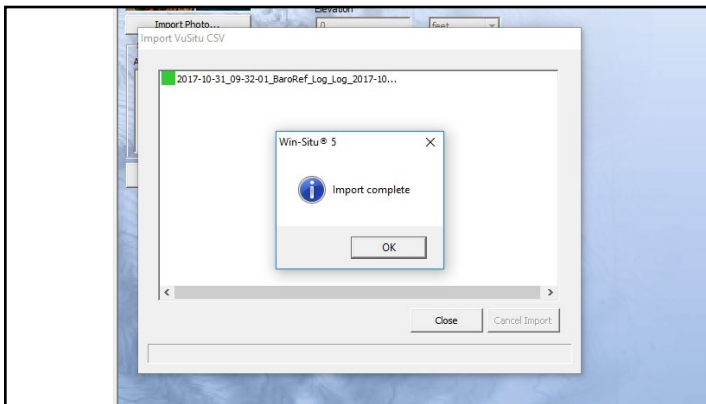

Select **OK** at the prompt.

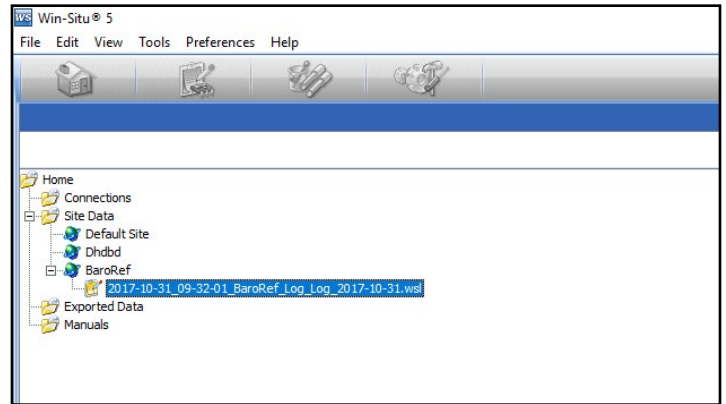

Click on the file name to view it.

## Using BaroMerge software

BaroMerge Software is used to post-correct absolute (non-vented) level sensor data to eliminate barometric pressure effects from the measurements. BaroMerge Software can be accessed through the Win-Situ 5 Software Tools menu. BaroMerge provides three options to correct data.

- Fixed Correction—A single offset value is applied to all selected log data. Use this option if you know the barometric pressure of the site during the log, and know that it did not change.
- Manual Entry—Specify two or more correction values to apply to the log data. Use this option if you wish to manually enter a data set of barometric pressure values.
- BaroTROLL log file—Absolute level sensor data points are individually corrected to reflect barometric pressure changes that were logged by a BaroTROLL instrument during the approximate time period.



## BaroMerge input—BaroTROLL file

Log files that contain absolute data can be barometrically compensated using values logged by the In-Situ Inc. BaroTROLL Instrument. Select this method when you have access to a BaroTROLL log file covering approximately the same time period as the data file you intend to correct.

To use this correction method, you need the name of the BaroTROLL log file and the name(s) of the absolute log file(s) you want to correct.

1. From the Tools menu in Win-Situ 5 Software, select Win-Situ BaroMerge.



2. Select the “Use a BaroTROLL file:” option.
3. Click the browse button to the right of the file field.
4. Select a BaroTROLL file and click the check mark.
5. Values from the BaroTROLL file will be displayed in the next window. You can edit these values if necessary.
6. Click the right arrow button.
7. Select the log file(s) you intend to correct and click the check mark.
8. Compensated data files can be viewed or exported from the Data tab.

## BaroMerge output

Your original log file is not changed. A new, corrected log file with the same name and path is created. The original “.wsl” extension is replaced by “-Baro Merge.wsl”.

## Disconnecting an instrument from the software

Click the plug icon in the lower-right corner of the screen to disconnect the instrument from the software. Disconnect the instrument from the communication device. Attach a desiccant pack if you are using a vented cable.



# Cleaning & maintenance

## Overview

It is important for users to perform scheduled maintenance on their instruments to sustain the accuracy and longevity of the probes and cables. The frequency of this maintenance depends on the characteristics of the deployment site, including humidity levels and the degree of fouling.

Users should be aware of the conditions at their deployment sites and develop appropriate maintenance schedules to replace desiccant, clean the instruments, and send in the instruments for factory calibration. Users should check instruments often during the first portion of the deployment to determine the frequency of maintenance. General maintenance should be performed as often as possible. Factory maintenance and calibration should be performed every 12 to 18 months.

## Operating considerations

The instrument has been designed to withstand harsh field conditions. However, as with any electronic instrument, it can be permanently damaged if used outside its operating specifications.

### Temperature

Review the instrument specifications to determine the operating range. Do not deploy instruments in such a way that ice may form on or near the sensors or cable connections. Ice formation is a powerful expansive force that can over-pressurize the sensor or otherwise cause damage that is not covered by the warranty.

### Pressure range

The instrument can withstand pressures of up to two times (2X) the rated range of the pressure sensor without damage, although it may not read correctly at such pressure. If the pressure range is exceeded by 3X, the sensor will be destroyed.

### Batteries

Internal batteries in the instrument are not user-replaceable. The approximate percentage remaining is displayed in Win-Situ software or the Vu-Situ mobile app when the instrument is connected. If batteries are completely exhausted, external power and battery pack options are available. See page 24.

## Desiccant pack options

### Small desiccant

The Small Desiccant is a disposable cap that ships with In-Situ products. The small desiccant is meant to protect the instrument and cable only during shipping and should not be used for deployments.



### Large and extra large desiccant

The Large and Extra-Large Desiccant are used to protect equipment deployed in the field. The Large Desiccant is best suited for low-humidity environments or deployments where maintenance occurs regularly. The Extra-Large Desiccant is designed for high-humidity environments or deployments where maintenance occurs infrequently. Extra-Large Desiccants provide six times the drying capability of the Large Desiccant. When the desiccant expires, both can be refilled with fresh desiccant and re-used (see Desiccant Refill Kit below). The Large Desiccant is available with an ABS or a titanium twist-lock connector, while the Extra Large Desiccant uses a titanium connector only.



Description	Part number
Large desiccant, titanium	0051810
Large desiccant, ABS	0053550
Extra large desiccant	0090420

### Desiccant refill kit

The Desiccant Refill Kit supplies desiccant for the Large Desiccant, Extra Large Desiccant, and the Outboard Desiccant. It also contains replacement glass wool.

Description	Part number
Desiccant refill kit	0029140

### Outboard Desiccant

The Outboard Desiccant is a replaceable desiccant pack designed to attach to the vent tube of the flying leads.

Description	Part number
Outboard Desiccant	0051380

## Installing desiccant with Twist-lock connectors

1. Remove the protective dust cap from the bottom of the desiccant pack, if applicable.
2. Remove expiring desiccant (if present) from the cable by grasping the textured section of the cable connector in one hand and the desiccant in the other. Twist in opposite directions to unlock the desiccant from the cable.
3. Attach the new desiccant pack to the twist-lock connector on the cable.



## Installing outboard desiccant

Vented cable must be installed with outboard desiccant to protect the cable and instrument electronics from condensation in high-humidity environments.

The desiccant can be removed from the vent tube, if necessary, to trim the conductor wires. However, you must reinstall the desiccant after trimming and connecting the wires.

1. Cut off the knot at the bottom of the vent tube extension.
2. Firmly attach the vent tube extension to the cable vent tube. Cover at least 6.4 mm (0.25 in.) of the cable vent tube for a secure attachment.
3. Use the attached hook-and-loop strap to secure the desiccant to the cable.
4. Remove the red dust cap from the black nylon cap to allow air to reach the cable's vent tube.

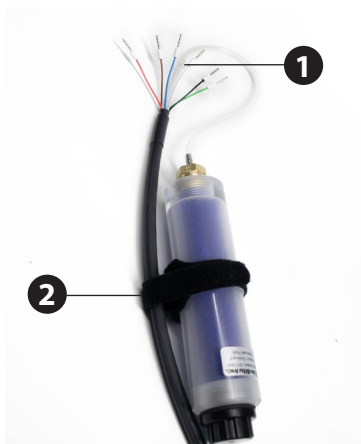

1	Outboard desiccant is attached to the cable vent tube.
2	Desiccant is secured to the cable with a strap.

## Using the desiccant refill kit

1. Remove the black nylon vent cap from the top of the desiccant.
2. Pour out and discard the used desiccant. Check the glass wool in the bottom of the container and replace if necessary.
3. Fill the container with fresh desiccant. Replace the vent cap. Reattach to cable if removed.



The glass wool prevents the desiccant beads from falling out the cable end of the desiccant pack. If the wool glass does this effectively, there is no need to replace it when refilling the desiccant.

## Antifouling

### TROLL shield nose cone

The copper TROLL Shield Nose Cone is designed to reduce macro- and micro-fouling of the pressure sensor on Level TROLL and Aqua TROLL Instruments. Reduced fouling on the sensor improves measurement accuracy and extends the length of deployments.

For optimum performance, the TROLL Shield Nose Cone should be replaced every 12 months or sooner if site conditions are extremely harsh.

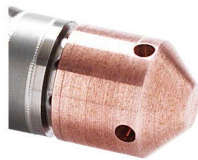

Description	Part number
TROLL shield nose cone	0081480

## O-ring inspection and replacement

Examine O-rings for wear, dryness, discoloration, stretching, cracks, nicks, and brittleness. Replace O-rings when any of these conditions are present. Replacing O-rings on an annual basis, regardless of their condition, is the best way to protect against moisture damage.

Perform the following steps to replace an O-ring.

1. Remove and discard the damaged O-ring.
2. Use a clean, dry, soft cloth to clean the O-ring groove to remove dirt or residue.
3. Lubricate the new O-ring using high-vacuum grease.
  - a. Wash your hands thoroughly.
  - b. Apply a small amount of grease to the pad of your index finger, and rub your index finger and thumb together to spread the grease evenly.
  - c. Inspect the new O-ring and remove any debris stuck to it.
4. Rub your fingers around the O-ring until there is a thin layer of grease on the entire O-ring.
5. Install the O-ring in the groove and remove any excess lubricant with a clean cloth.



Do not allow water or lubricant to enter the connector.

## Cleaning the instrument

Clean the instrument body with water and a soft brush or plastic scouring pad, or soak overnight in a mild acidic solution, such as household vinegar. NEVER submerge the connector portion of the instrument when it is not connected to a cable.

If the ports near the pressure sensor are clogged with silt or mud, try the following procedures.

- Agitate the instrument vigorously in a bucket of clean water.
- Apply a gentle rinse of water from a wash bottle.
- In severe cases, remove the nose cone and clean out the holes with a soft brush or pipe cleaner.

Do not attempt to remove material from the instrument by tapping the instrument against a surface. To avoid damage to the pressure sensor diaphragm, do not insert any object into the sensor opening or attempt to dig out dirt or other materials. You void the instrument's warranty by inserting anything into the sensor opening. If contamination cannot be removed using the recommendations above, please contact In-Situ for cleaning.



Do not insert ANY object into the sensor opening. Doing so voids the warranty.

## Twist-lock connectors

Keep the pins on all connectors free of dirt and moisture by using the soft protective dust caps when cable is not attached.

## Storage

Store the instrument in a clean, dry place. Place the protective red dust cap on the cable end or store with cable attached to protect the connector pins and O-ring. For vented cables, ensure the desiccant used is the appropriate size and change it when needed. Store the instrument where it will not roll off a bench onto a hard surface or sustain other mechanical shock. Protect the instrument from temperature extremes using the following guidelines:



Level TROLL Instruments—store within the temperature range -40° C to +80° C (-40° F to 176° F)

## ***Factory calibration and service***

### **In-house factory calibration**

Factory calibration of In-Situ instruments should be performed every 12 to 18 months, or at any point when the data appears to drift significantly. Factory calibration includes a thorough cleaning, all operational checks, necessary firmware upgrades, O-ring replacement, and full range calibrations of the pressure sensor, temperature sensor, and conductivity sensor (when applicable).

### **Return Materials Authorization (RMA) Form**

To obtain a factory calibration, fill out and return the online Return Materials Authorization (RMA) form located at [www.in-situ.com/](http://www.in-situ.com/).

### **Obtaining repair service**

If you suspect your system is malfunctioning and repair is needed, you can help assure efficient servicing by following these guidelines:

1. Call or email In-Situ Technical Support. Have the product model and serial number available.
2. Be prepared to describe the problem, including how the product was used and the conditions noted at the time of the malfunction.
3. If Technical Support determines that service is needed, they will ask your company to fill out the RMA form and pre-approve a specified monetary amount for repair charges. When the form and pre-approval is received, Technical Support will assign an RMA (Return Material Authorization) number.
4. Clean the product as described in the manual.
5. If the product contains a removable battery, remove and retain it unless you are returning the system for a refund or Technical Support states otherwise.
6. Carefully pack your product in its original shipping box, if possible.
7. Mark the RMA number clearly on the outside of the box.
8. Send the package, shipping prepaid, to:

In-Situ  
ATTN: Repairs  
221 East Lincoln Avenue  
Fort Collins, CO 80524

The warranty does not cover damage during transit. In-Situ recommends insurance for all shipments. Warranty repairs will be shipped back prepaid.

### **Outside the US**

Contact your international In-Situ distributor for repair and service information.

## Guidelines for cleaning returned equipment

Please help us protect the health and safety of our employees by cleaning and decontaminating equipment that has been subjected to potential biological or health hazards, and labeling such equipment. Unfortunately, we cannot service your equipment without such notification. Please complete and sign the form on page 78 (or a similar statement certifying that the equipment has been cleaned and decontaminated) and send it to us with each instrument.

- We recommend the glassware cleaning product, Alconox, available from In-Situ and from laboratory supply companies.
- Clean all cables and remove all foreign matter.
- Clean the cable connectors with a clean, dry cloth. Do not submerge the connectors.
- Clean the instrument including the nosecone, cable head, and protective caps.



If an instrument is returned to our Service Center for repair or recalibration without a statement that it has been cleaned and decontaminated, or if it is the opinion of our Service Representatives that the equipment presents a potential health or biological hazard, we reserve the right to withhold service until proper certification is obtained.

### ***Decontamination & cleaning statement***

Company Name	Phone
Address	
City	State
Instrument Type	Serial Number
Contaminant(s) if known	
Decontamination procedure(s) used	
Cleaning verified by	Title
Date	

## Troubleshooting

In addition to the following troubleshooting items, the In-Situ website includes instructional videos, technical notes, and more. See [www.help.in-situ.com](http://www.help.in-situ.com).

Problem	Possible cause	Solution
Win-Situ 5 Software cannot connect to the instrument.	Wrong COM port is selected, communication settings are incompatible, cable connections are loose or dirty, or batteries are low.	<p>Make sure cable connections are tight and connectors are clean and dry.</p> <p>Make sure the cable is securely attached to the instrument.</p> <p>Make sure the correct COM port is selected (select Preferences &gt; Comm Settings to verify).</p> <p>Make sure the communication settings in Win-Situ and in the instrument match. To reset the device communication settings to the serial defaults, click "Reset all Devices" in the Comm Settings dialog (Preferences &gt; Comm Settings).</p> <p>Make sure the internal battery has voltage remaining, or external power is supplied.</p> <p>See <a href="http://www.in-situ.com/Technical_notes">www.in-situ.com/Technical_notes</a> and scroll to the Communications and Software Technical Notes section for more information.</p>
Real-time readings display the wrong units.	Default units are being used.	Click the Sensors tab, select the sensor, click the configure button and select the desired units for each parameter in the Sensor Setup window.
Cannot add a new log.	<p>Only one active log can reside in the device at a time—an active log is a log that is Ready, Pending, Running, or Suspended as shown in the Status column of the Logging Tab.</p> <p>The device has its maximum number of logs already stored—the Level TROLL 300, 500, and Baro TROLL have a capacity of 2 logs.</p>	<p>Stop or delete the log if possible. Alternatively, configure the new log after the active log is completed.</p> <p>Download, and then delete a log you no longer need. This will make room for an additional log on the device.</p>



<p>New log exceeds available memory (software message).</p>	<p>The log as configured would exceed the device memory.</p>	<p>Edit the log and select a longer sampling interval.          If available, select the “wrap data” option. This causes more recent data to overwrite older data when memory is full.          For a log with a scheduled start, select None as the stop condition, or select a stop time that is closer to the start time.</p>
<p>Cannot configure level or other parameters using the Configure button on the Sensors tab. The Sensor Setup screen is shown, but the Configure... button is dim.</p>	<p>The instrument is actively polling (continually updating real-time readings) in the Home tab. The instrument has an active log—a log that is Ready, Pending, Running, or Suspended as shown in the Status column of the Logging tab. Only one active log can reside in the device at a time.</p>	<p>Return to the Home tab and stop real-time readings by clicking the Play button.           Stop or delete the log if possible. Alternatively, configure parameters after the log is complete.</p>

# Declarations of Conformity and Similarity

## Level TROLL 400



# In-Situ

Innovations in Water Monitoring

### CE Declaration of Similarity

**Manufacturer:** In-Situ, Inc.  
221 East Lincoln Avenue, Fort Collins, CO 80524, USA

Declares that performance of each of the following products is equivalent to the Level TROLL 700 :

Product name: Level TROLL 400

Model: Level TROLL 400

Part Numbers: 0099240, 0099250, 0099260, 0099270

Product Description: The Level TROLL 400 is a sensor used to measure and log the depth of water.

Model Variants: Variants of the Level TROLL 400 include sensors which are Gauged (vented) which are denoted with a "G" and Actual (non-vented) which are denoted with an "A". The numerical values indicate the maximum pressure range. These are the model variants: 5 PSIG, 15 PSIG, 30 PSIG, 100 PSIG, 300 PSIG, 500 PSIG, 30 PSIA, 100 PSIA, 300 PSIA, 500 PSIA.

These are in compliance with the following Directives:

- 2014/30/EU EMC Directive
- 2014/35/EU Low-Voltage Directive
- Restriction of the use of certain hazardous substances in electrical and electronic equipment (RoHS) Directive, 2011/65/EU and Commission Delegated Directive, (EU) 2015/863

and meet or exceed the following international requirements and compliance standards:

**EMC Standard:**

EN 61326-1:2021

**Safety Standard:**

EN 60300-1:2010 + A1:2019

**RoHS Standard:**

EN 63000:2018

The CE mark is affixed accordingly.

David A. Bossie  
Regulatory Compliance Manager  
In-Situ, Inc.  
July 12, 2022





## UKCA Declaration of Similarity

**Manufacturer:** In-Situ, Inc.  
221 East Lincoln Avenue, Fort Collins, CO 80524, USA

Declares that performance of each of the following products is equivalent to the Level TROLL 700 :

Product name: Level TROLL 400

Model: Level TROLL 400

Part Numbers: 0099246, 0099250, 0099258, 0099270

Product Description: The Level TROLL 400 is a sensor used to measure and log the depth of water.

Model Variants: Variants of the Level TROLL 400 include sensors which are Gauged (vented) which are denoted with a "G" and Actual (non-vented) which are denoted with an "A". The numerical values indicate the maximum pressure range. These are the model variants: 5 PSIG, 15 PSIG, 30 PSIG, 100 PSIG, 300 PSIG, 500 PSIG, 30 PSIA, 100 PSIA, 300 PSIA, 500 PSIA.

These products are in compliance with the following Regulations:

- EMC Regulation 2016
- Electrical Equipment (Safety) Regulation 2018
- Restriction of the use of certain hazardous substances in electrical and electronic equipment (RoHS) Regulation (S.I. 2012:3032)

and meet or exceed the following British requirements and compliance standards:

- EMC Standard: BS 61326:2021
- Safety Standard: BS EN 61010-1:2010 + A1:2018
- RoHS: BS 63001:2018

The UKCA mark is affixed accordingly.

**David A. Bossie**  
Regulatory Compliance Manager  
In-Situ, Inc.  
July 12, 2022





### CE Declaration of Similarity

**Manufacturer:** In-Situ, Inc.  
221 East Lincoln Avenue, Fort Collins, CO 80524, USA

Declares that performance of each of the following products is equivalent to the Level TROLL 700 :

Product name: Level TROLL 500

Model: Level TROLL 500

Part Numbers: 0005000, 0005010, 0005020, 0005030, 0005040, 0005050

Product Description: The Level TROLL 500 is a sensor used to measure and log the depth of water.

Model Variants: Variants of the Level TROLL 400 include sensors which are Gauged (vented) which are denoted with a "G" and Actual (non-vented) which are denoted with an "A". The numerical values indicate the maximum pressure range. These are the model variants: 5 PSIG, 15 PSIG, 30 PSIG, 100 PSIG, 300 PSIG, 500 PSIG, 30 PSIA, 100 PSIA, 300 PSIA, 500 PSIA.

These are in compliance with the following Directives:

- 2014/30/EU EMC Directive
- 2014/35/EU Low-Voltage Directive
- Restriction of the use of certain hazardous substances in electrical and electronic equipment (RoHS) Directive, 2011/65/EU and Commission Delegated Directive, (EU) 2015/863

and meet or exceed the following international requirements and compliance standards:

**EMC Standard:**

EN 61326-1:2021

**Safety Standard:**

EN 60900-1:2010 + A1:2019

**RoHS Standard:**

EN 60900:2018

The CE mark is affixed accordingly.

David A. Bossie  
Regulatory Compliance Manager  
In-Situ, Inc.  
July 12, 2022





## UKCA Declaration of Similarity

**Manufacturer:** In-Situ, Inc.  
221 East Lincoln Avenue, Fort Collins, CO 80524, USA

Declares that performance of each of the following products is equivalent to the Level TROLL 700 :

Product name: Level TROLL 500

Model: Level TROLL 500

Part Numbers: 0003000, 0003010, 0003020, 0003030, 0003040, 0003050

Product Description: The Level TROLL 500 is a sensor used to measure and log the depth of water.

Model Variants: Variants of the Level TROLL 400 include sensors which are Gauged (vented) which are denoted with a "G" and Actual (non-vented) which are denoted with an "A". The numerical values indicate the maximum pressure range. These are the model variants: 5 PSIG, 15 PSIG, 30 PSIG, 100 PSIG, 300 PSIG, 500 PSIG, 30 PSIA, 100 PSIA, 300 PSIA, 500 PSIA.

These products are in compliance with the following Regulations:

- EMC Regulation 2016
- Electrical Equipment (Safety) Regulation 2018
- Restriction of the use of certain hazardous substances in electrical and electronic equipment (RoHS) Regulation (S.I. 2012:3032)

and meet or exceed the following British requirements and compliance standards:

- EMC Standard: BS 61326:2021
- Safety Standard: BS EN 61010-1:2010 + A1:2018
- RoHS: BS 63001:2018

The UKCA mark is affixed accordingly.

David A. Bossie  
Regulatory Compliance Manager  
In-Situ, Inc.  
July 12, 2022





### CE Declaration of Conformity

**Manufacturer:** In-Situ, Inc.  
221 East Lincoln Avenue, Fort Collins, CO 80524, USA

Declares that the following product:

Product name: Level TROLL 700

Model: Level TROLL 700

Part Number(s): 0088110, 0088120, 0088130, 0088140, 0088150, 0088160, 0088550

Product Description: The Level TROLL 700 is a sensor used to measure and log the depth of water.

Model Variants: Variants of the Level TROLL 700 include sensors which are Gauged (vented) which are denoted with a "G" and Actual (non-vented) which are denoted with an "A". The numerical values indicate the maximum pressure range. These are the model variants: 5 PSIG, 15 PSIG, 30 PSIG, 100 PSIG, 300 PSIG, 500 PSIG, 30 PSIA, 100 PSIA, 300 PSIA, 500 PSIA, 1000 PSIA.

is in compliance with the following Directive

- 2014/30/EU EMC Directive
- Restriction of the use of certain hazardous substances in electrical and electronic equipment (RoHS) Directive, 2011/65/EU and Commission Delegated Directive, (EU) 2015/863

and meets or exceeds the following international requirements and compliance standards:

**EMC Standards:**

EN 61326-1:2021

**RoHS Standard:**

EN 63000:2018

The CE mark is affixed accordingly.

David A. Bossie  
Regulatory Compliance Manager  
In-Situ, Inc.  
July 12, 2022





## UKCA Declaration of Conformity

**Manufacturer:** In-Situ, Inc.  
221 East Lincoln Avenue, Fort Collins, CO 80524, USA

We declare that the performance of the following product:

**Product name:** Level TROLL 700

**Model:** Level TROLL 700

**Part Number(s):** 0088110, 0088120, 0088130, 0088140, 0088150, 0088160, 0088550

**Product Description:** The Level TROLL 700 is a sensor used to measure and log the depth of water.

**Model Variants:** Variants of the Level TROLL 700 include sensors which are Gauged (vented) which are denoted with a "G" and Actual (non-vented) which are denoted with an "A". The numerical values indicate the maximum pressure range. These are the model variants: 5 PSIG, 15 PSIG, 30 PSIG, 100 PSIG, 300 PSIG, 500 PSIG, 30 PSIA, 100 PSIA, 300 PSIA, 500 PSIA.

is in compliance with the following Regulations:

- EMC Regulation 2016
- Restriction of the use of certain hazardous substances in electrical and electronic equipment (RoHS) Regulation (S.I. 2012:3032)

and meets or exceeds the following British requirements and compliance standards:

- EMC: BS 61328-1:2021
- RoHS: BS 63001:2018

The UKCA mark is affixed accordingly.

David A. Bossie  
Regulatory Compliance Manager  
In-Situ, Inc.  
July 12, 2022





**CE Declaration of Similarity**

**Manufacturer:** In-Situ, Inc.  
221 East Lincoln Avenue, Fort Collins, CO 80524, USA

Declares that performance of each of the following products is equivalent to the Level TROLL 700 :

Product name: Baro TROLL

Model: Baro TROLL

Part Number: 0089100

Product Description: Barometric pressure Data Logger

Model Variants: None

This is in compliance with the following Directives:

- 2014/53/EU EMC Directive
- Restriction of the use of certain hazardous substances in electrical and electronic equipment (RoHS) Directive, 2011/65/EU and Commission Delegated Directive, (EU) 2015/863

and meets or exceeds the following international requirements and compliance standards:

**EMC Standard:**  
EN 61326-1:2021

**RoHS Standard:**  
EN 63000:2018

The CE mark is affixed accordingly.

David A. Bossie  
Regulatory Compliance Manager  
In-Situ, Inc.  
July 12, 2022







## UKCA Declaration of Similarity

**Manufacturer:** In-Situ, Inc.  
221 East Lincoln Avenue, Fort Collins, CO 80524, USA

**Declares that performance of each of the following products is equivalent to the Level TROLL 700 :**

**Product name:** Baro TROLL

**Model:** Baro TROLL

**Part Number:** 0089100

**Product Description:** Barometric pressure Data Logger

**Model Variants:** None

**This is in compliance with the following Regulations:**

- EMC Regulation 2016
- Restriction of the use of certain hazardous substances in electrical and electronic equipment (RoHS) Regulation (S.I. 2012:3032)

**and meets or exceeds the following British requirements and compliance standards:**

- EMC Standard: BS 61326:2021
- RoHS: BS 63001:2018

**The UKCA mark is affixed accordingly.**

**David A. Bossie**  
Regulatory Compliance Manager  
In-Situ, Inc.  
July 12, 2022





**CE Declaration of Similarity**

**Manufacturer:** In-Situ, Inc.  
221 East Lincoln Avenue, Fort Collins, CO 80524, USA

Declares that performance of each of the following products is equivalent to the Level TROLL 700 :  
**Product name:** TROLL Battery Pack  
**Model:** TROLL Battery Pack  
**Part Number:** 0051450  
**Product Description:** This product provides power to the Level TROLL products in the event their internal batteries are depleted.  
**Model Variants:** None

This is in compliance with the following Directives:

- 2014/30/EU EMC Directive
- Restriction of the use of certain hazardous substances in electrical and electronic equipment (RoHS) Directive, 2011/65/EU and Commission Delegated Directive, (EU) 2015/863

and meets or exceeds the following international requirements and compliance standards:

**EMC Standard:**  
EN 61326-1:2021

**RoHS Standard:**  
EN 63000:2018

The CE mark is affixed accordingly.

**David A. Bossie**  
**Regulatory Compliance Manager**  
**In-Situ, Inc.**  
**July 13, 2022**





## UKCA Declaration of Similarity

**Manufacturer:** In-Situ, Inc.  
221 East Lincoln Avenue, Fort Collins, CO 80524, USA

Declares that performance of each of the following products is equivalent to the Level TROLL 700 :

Product name: TROLL Battery Pack

Model: TROLL Battery Pack

Part Number: 0051450

Product Description: This product provides power to the Level TROLL products in the event their internal batteries are depleted.

Model Variants: None

This product is in compliance with the following Regulations:

- EMC Regulation 2016
- Restriction of the use of certain hazardous substances in electrical and electronic equipment (RoHS) Regulation (S.I. 2012:3032)

and meets or exceeds the following British requirements and compliance standards:

- EMC Standard: BS 61328:2021
- RoHS: BS 63001:2018

The UKCA mark is affixed accordingly.

David A. Bossie  
Regulatory Compliance Manager  
In-Situ, Inc.  
July 13, 2022





**CE Declaration of Conformity**

**Manufacturer:** In-Situ, Inc.  
221 East Lincoln Avenue, Fort Collins, CO 80524, USA

**Declares that the following product:**

**Product name:** TROLL Com

**Model:** TROLL Com

**Part Number(s):** 0052500, 0052510

**Product Description:** The TROLL Com is used to connect a water quality sensor to the laptop computer to monitor results or to set up and download a log.

**Model Variants:** The TROLL Com models vary by the type of connection through which the product connects to the sensor. The TROLL Com is available with a Direct connection or twist-lock connection.

**is in compliance with the following Directive**

- 2014/53/EU EMC Directive
- Restriction of the use of certain hazardous substances in electrical and electronic equipment (RoHS) Directive, 2011/65/EU and Commission Delegated Directive, (EU) 2015/863

**and meets or exceeds the following international requirements and compliance standards:**

**EMC Standards:**

EN 61326-1:2021

**RoHS Standard:**

EN 63000:2018

**The CE mark is affixed accordingly.**

**David A. Bossie**  
**Regulatory Compliance Manager**  
In-Situ, Inc.  
July 13, 2022





## UKCA Declaration of Conformity

**Manufacturer:** In-Situ, Inc.  
221 East Lincoln Avenue, Fort Collins, CO 80524, USA

We declare that the performance of the following product:

**Product name:** TROLL Cam

**Model:** TROLL Cam

**Part Number(s):** 0052500, 0052510

**Product Description:** The TROLL Cam is used to connect a water quality sensor to the laptop computer to monitor results or to set up and download a log.

**Model Variants:** The TROLL Cam models vary by the type of connection through which the product connects to the sensor. The TROLL Cam is available with a Direct connection or twist-lock connection.

is in compliance with the following Regulations:

- EMC Regulation 2016
- Restriction of the use of certain hazardous substances in electrical and electronic equipment (RoHS) Regulation (S.I. 2012:3032)

and meets or exceeds the following British requirements and compliance standards:

- EMC: BS 61328-1:2021
- RoHS: BS 63001:2018

The UKCA mark is affixed accordingly.

David A. Bossie  
Regulatory Compliance Manager  
In-Situ, Inc.  
July 13, 2022



# Appendix

## Appendix A: Parameter Numbers and Locations

ID	Parameter Name	Holding Register Number	Holding Register Address	Default Units
1	Temperature	0046	0045	1 = °C
2	Pressure	0038	0037	17 = PSI
3	Depth	0054	0053	38 = feet
4	Level, Depth to Water (Enable with VuSitu)	0054	0053	38 = feet
5	Level, Surface Elevation (Enable with VuSitu)	0054	0053	38 = feet

## Appendix B: Unit IDs

ID	Abbreviation	Units
1	C	Celsius
2	F	Fahrenheit
<b>Pressure, Barometric Pressure (17-32)</b>		
17	PSI	Pounds per square inch
19	kPa	Kilopascals
20	Bar	Bars
21	mBar	Millibars
22	mmHg	Millimeters of Mercury (0 to C)
23	inHg	Inches of Mercury (4 to C)
24	cmH <sub>2</sub> O	Centimeters of water (4 to C)
25	inH <sub>2</sub> O	Inches of water (4 to C)
<b>Distance/Length (33-48)</b>		
33	mm	Millimeters
34	cm	Centimeters
35	m	Meters
37	in	Inches
38	ft	Feet