

**Model 42i
High Level**

Instruction Manual

Chemiluminescence NO-NO₂-NO_x Analyzer

Part Number 101903-00

20Dec2007



CE

Thermo
SCIENTIFIC

© 2007 Thermo Fisher Scientific Inc. All rights reserved.

Specifications, terms and pricing are subject to change. Not all products are available in all countries. Please consult your local sales representative for details.

Thermo Fisher Scientific
Air Quality Instruments
27 Forge Parkway
Franklin, MA 02038
1-508-520-0430
www.thermo.com/aqi

WEEE Compliance

This product is required to comply with the European Union's Waste Electrical & Electronic Equipment (WEEE) Directive 2002/96/EC. It is marked with the following symbol:



Thermo Fisher Scientific has contracted with one or more recycling/disposal companies in each EU Member State, and this product should be disposed of or recycled through them. Further information on Thermo Fisher Scientific's compliance with these Directives, the recyclers in your country, and information on Thermo Fisher Scientific products which may assist the detection of substances subject to the RoHS Directive are available at: www.thermo.com/WEEERoHS.

Contents

Chapter 1	Introduction	1-1
	Principle of Operation	1-2
	Specifications	1-3
Chapter 2	Installation	2-1
	Lifting.....	2-1
	Unpacking and Inspection	2-1
	Setup Procedure.....	2-2
	Startup	2-5
Chapter 3	Operation	3-1
	Display.....	3-2
	Pushbuttons	3-3
	Soft Keys.....	3-4
	Software Overview	3-4
	Power-Up Screen	3-6
	Run Screen.....	3-6
	Main Menu.....	3-7
	Range Menu	3-8
	Single Range Mode.....	3-8
	Dual Range Mode.....	3-10
	Auto Range Mode.....	3-11
	Gas Units	3-14
	NO, NO ₂ , and NO _x Ranges.....	3-14
	Set Custom Ranges	3-16
	Averaging Time.....	3-17
	Calibration Factors Menu	3-18
	NO and NO _x Backgrounds.....	3-18
	NO, NO ₂ , and NO _x Coefficients	3-20
	Calibration Pressure	3-21
	Calibration Menu	3-22
	Calibrate NO and NO _x Background.....	3-23
	Calibrate NO, NO ₂ , and NO _x Coefficients	3-24
	Calibrate Pressure.....	3-25
	Zero/Span Check	3-25

Instrument Controls Menu	3-29
Ozonator.....	3-29
PMT Supply	3-30
Auto/Manual Mode	3-30
Datalogging Settings	3-31
Communication Settings.....	3-41
I/O Configuration.....	3-49
Temperature Compensation.....	3-61
Pressure Compensation	3-62
Screen Contrast.....	3-63
Service Mode	3-63
Date/Time	3-64
Diagnostics Menu	3-64
Program Version	3-65
Voltages	3-65
Temperatures	3-67
Pressure.....	3-67
Flow.....	3-67
Analog Input Readings.....	3-68
Analog Input Voltages.....	3-68
Digital Inputs.....	3-69
Relay States.....	3-69
Test Analog Outputs.....	3-69
Instrument Configuration	3-71
Contact Information	3-71
Alarms Menu	3-72
Internal Temperature	3-73
Chamber Temperature.....	3-74
Cooler Temperature.....	3-75
Converter Temperature.....	3-76
Pressure.....	3-77
Flow.....	3-78
Ozonator Flow.....	3-78
Zero and Span Check.....	3-79
Zero and Span Auto Calibration	3-80
NO, NO ₂ , and NO _x Concentration	3-80

Service Menu	3-82
PMT Voltage Adjustment	3-83
Range Mode Select.....	3-83
Converter Set Temperature	3-84
Pressure Calibration	3-84
Flow Calibration	3-87
Input Board Calibration.....	3-89
Temperature Calibration.....	3-91
Analog Output Calibration	3-92
Analog Input Calibration	3-94
Ozonator Safety	3-95
Dilution Ratio.....	3-96
Display Pixel Test	3-96
Restore User Defaults.....	3-97
Password	3-98
Set Password	3-98
Lock Instrument	3-99
Change Password	3-99
Remove Password.....	3-100
Unlock Instrument	3-100
Chapter 4 Calibration.....	4-1
Equipment Required.....	4-1
Pre-Calibration	4-1
Calibration.....	4-2
Connecting the GPT Apparatus.....	4-3
Dynamic Parameter Specifications for Gas Phase Titrator	4-4
Adjusting Instrument Gain	4-6
Preparing NO, NO _x , and NO ₂ Calibration Curves	4-9
Calibration in Dual Range and Auto Range Mode.....	4-11
Calibrate Low NO	4-13
Calibrate Low NO _x	4-13
Calibrate Low NO ₂	4-14
Calibrate High NO.....	4-14
Calibrate High NO _x	4-15
Calibrate High NO ₂	4-15
Zero and Span Check.....	4-16
Chapter 5 Preventive Maintenance	5-1
Safety Precautions	5-1
Replacement Parts.....	5-1
Cleaning the Outside Case.....	5-2
Ozonator Air Feed Drying Column Replacement	5-2
Capillaries Inspection and Replacement	5-2

	Thermoelectric Cooler Fins Inspection and Cleaning.....	5-4
	Fan Filters Inspection and Cleaning.....	5-4
	Pump Rebuilding.....	5-5
Chapter 6	Troubleshooting.....	6-1
	Safety Precautions	6-1
	Troubleshooting Guides.....	6-2
	Board-Level Connection Diagrams	6-6
	Connector Pin Descriptions	6-8
	Service Locations.....	6-22
Chapter 7	Servicing.....	7-1
	Safety Precautions	7-3
	Firmware Updates.....	7-4
	Replacement Parts List	7-4
	Cable List.....	7-6
	Removing the Measurement Bench and Lowering the Partition Panel	7-8
	Pump Replacement	7-9
	Fan Replacement.....	7-10
	PMT Cooler and Reaction Chamber Assembly Replacement.....	7-11
	Photomultiplier Tube Replacement	7-13
	PMT High Voltage Power Supply Replacement	7-15
	PMT Voltage Adjustment.....	7-17
	Reaction Chamber Cleaning or Removal	7-18
	NO ₂ -to-NO Converter Replacement.....	7-20
	Solenoid Valve Replacement	7-22
	Ozonator Assembly Replacement	7-23
	Ozonator Transformer Replacement	7-25
	Input Board Replacement	7-25
	Input Board Calibration.....	7-27
	DC Power Supply Replacement	7-28
	Analog Output Testing.....	7-29
	Analog Output Adjustment.....	7-31
	Pressure Transducer Assembly Replacement.....	7-32
	Pressure Transducer Calibration	7-34
	Temperature Control Board Replacement.....	7-36
	Ambient Temperature Calibration	7-36
	Fuse Replacement	7-38
	Scrubber Replacement.....	7-38
	I/O Expansion Board (Optional) Replacement	7-39
	Digital Output Board Replacement.....	7-40
	Motherboard Replacement.....	7-41

Measurement Interface Board Replacement	7-42
Front Panel Board Replacement	7-43
LCD Module Replacement	7-44
Service Locations.....	7-46
Chapter 8 System Description.....	8-1
Hardware	8-1
NO ₂ -to-NO Converter	8-2
Mode Solenoid.....	8-2
Reaction Chamber	8-2
Optical Filter	8-3
Pressure Transducer	8-3
Ozonator.....	8-3
Ozonator Flow Switch	8-3
Photomultiplier Tube	8-3
Photomultiplier Tube Cooler.....	8-3
External Pump	8-3
Sample Capillary	8-3
Dry Air Capillary	8-4
Software	8-4
Instrument Control.....	8-4
Monitoring Signals.....	8-4
Measurement Calculations	8-5
Output Communication	8-5
Electronics	8-6
Motherboard.....	8-6
Measurement Interface Board	8-7
Pressure Sensor Assembly	8-7
Temperature Control Board.....	8-7
PMT Power Supply Assembly.....	8-8
Input Board Assembly.....	8-8
Digital Output Board.....	8-8
I/O Expansion Board (Optional)	8-8
Front Panel Connector Board	8-9
I/O Components	8-9
Analog Voltage Outputs.....	8-9
Analog Current Outputs (Optional)	8-10
Analog Voltage Inputs (Optional)	8-10
Digital Relay Outputs	8-10
Digital Inputs.....	8-10
Serial Ports	8-11
RS-232 Connection	8-11
RS-485 Connection	8-12
Ethernet Connection.....	8-12
External Accessory Connector	8-12

Chapter 9	Optional Equipment.....	9-1
	Internal Zero/Span Assembly	9-1
	Bypass Flow	9-3
	Permeation Dryer Assembly	9-3
	Ammonia Scrubber	9-3
	Teflon Particulate Filter	9-4
	Ozone Particulate Filter	9-4
	NO ₂ -to-NO Converter	9-4
	I/O Expansion Board Assembly.....	9-4
	Terminal Block and Cable Kits	9-4
	Mounting Options.....	9-5
Appendix A	Warranty	A-1
Appendix B	C-Link Protocol Commands	B-1
	Instrument Identification Number.....	B-2
	Commands	B-2
	Measurements	B-9
	Alarms.....	B-12
	Diagnostics	B-16
	Datalogging	B-17
	Calibration.....	B-24
	Keys/Display	B-27
	Measurement Configuration	B-29
	Hardware Configuration	B-32
	Communications Configuration	B-36
	I/O Configuration.....	B-40
	Record Layout Definition	B-44
Appendix C	MODBUS Protocol.....	C-1
	Serial Communication Parameters	C-2
	TCP Communication Parameters	C-2
	Application Data Unit Definition	C-2
	Function Codes.....	C-3
	MODBUS Commands Supported.....	C-8
Appendix D	Geysitech (Bayern-Hessen) Protocol.....	D-1

Figures

Model 42i High Level Flow Schematic	1-3
Model 42i High Level Rear Panel	2-2
Atmospheric Dump Bypass Plumbing	2-3
Twin-Head Vacuum Pump Installation	2-4
42i High Level Front Panel Display	3-2
Front Panel Pushbuttons	3-3
Flowchart of Menu-Driven Software	3-5
Pin-Out of Rear Panel Connector in Single Range Mode	3-9
Pin-Out of Rear Panel Connector in Dual Range Mode	3-10
Analog Output in Auto Range Mode	3-12
Pin-Out of Rear Panel Connector in Auto Range Mode	3-13
GPT System	4-3
Inspecting and Replacing the Capillaries	5-3
Rebuilding the Pump	5-6
Board-Level Connection Diagram - Common Electronics	6-6
Board-Level Connection Diagram - Measurement System	6-7
Properly Grounded Antistatic Wrist Strap	7-4
Component Layout	7-7
Removing the Measurement Bench and Lowering the Partition Panel	7-8
Replacing the Pump	7-10
Replacing a Fan	7-11
PMT Cooler and Reaction Chamber	7-12
Replacing the PMT	7-14
Replacing the PMT HVPS	7-16
Cleaning or Removing the Reaction Chamber	7-19
NO ₂ -to-NO Stainless Steel Converter Assembly	7-21
Replacing the Solenoid Valve	7-23
Replacing the Ozonator Assembly	7-24
Replacing the Input Board	7-26
Replacing the DC Power Supply	7-29
Rear Panel Analog Voltage Output Pins	7-30
Replacing the Pressure Transducer	7-33
Replacing the Scrubber	7-39
Replacing the I/O Expansion Board (Optional)	7-40
Rear Panel Board Connectors	7-40
Replacing the Measurement Interface Board	7-43
Replacing the Front Panel Board and the LCD Module	7-44
Hardware Components	8-2
Zero/Span Option Flow Diagram	9-2
Bypass Flow Option Flow Schematic	9-3
Rack Mount Option Assembly	9-5

Figures

Bench Mounting9-6
EIA Rack Mounting9-7
Retrofit Rack Mounting9-8
Flag Status B-12

Tables

Model 42i High Level Specifications	1-3
Front Panel Pushbuttons	3-3
Default Analog Outputs in Single Range Mode	3-9
Default Analog Outputs in Dual Range Mode	3-11
Default Analog Outputs in Auto Range Mode	3-13
Operating Ranges	3-15
Analog Output Zero to Full-Scale Table	3-55
Signal Type Group Choices	3-56
Troubleshooting - General Guide	6-2
Troubleshooting - Alarm Messages	6-3
Motherboard Connector Pin Descriptions	6-8
Measurement Interface Board Connector Pin Descriptions	6-13
Front Panel Board Connector Pin Diagram	6-16
I/O Expansion Board (Optional) Connector Pin Descriptions	6-18
Digital Output Board Connector Pin Descriptions	6-19
Input Board Connector Pin Descriptions	6-20
Temperature Control Board Connector Pin Descriptions	6-21
Model 42i High Level Replacement Parts	7-4
Model 42i High Level Cables	7-6
Analog Output Channels and Rear Panel Pin Connections	7-30
RS-232 DB Connector Pin Configurations	8-12
RS-485 DB Connector Pin Configuration	8-12
Mounting Options	9-5
C-Link Protocol Commands	B-3
Averaging Times	B-9
Alarm Trigger Values	B-16
Record Output Formats	B-20
Stream Time Values	B-24
Operating Ranges	B-29
Contrast Levels	B-33
Reply Termination Formats	B-38
Analog Current Output Range Values	B-40
Analog Voltage Output Range Values	B-41
Default Output Assignment	B-42
Read Coils for 42i High Level	C-8
Read Registers for 42i High Level	C-9
Write Coils for 42i High Level	C-10
Operating Status for Model 42i High Level	D-7
Error Status for Model 42i High Level	D-7

Tables

About This Manual

This manual provides information about operating, maintaining, and servicing the analyzer. It also contains important alerts to ensure safe operation and prevent equipment damage. The manual is organized into the following chapters and appendices to provide direct access to specific operation and service information:

- Chapter 1 “Introduction” provides an overview of product features, describes the principles of operation, and lists the specifications.
- Chapter 2 “Installation” describes how to unpack, setup, and startup the analyzer.
- Chapter 3 “Operation” describes the front panel display, the front panel pushbuttons, and the menu-driven software.
- Chapter 4 “Calibration” provides the procedures for calibrating the analyzer and describes the required equipment.
- Chapter 5 “Preventive Maintenance” provides maintenance procedures to ensure reliable and consistent instrument operation.
- Chapter 6 “Troubleshooting” presents guidelines for diagnosing analyzer failures, isolating faults, and includes recommended actions for restoring proper operation.
- Chapter 7 “Servicing” presents safety alerts for technicians working on the analyzer, step-by-step instructions for repairing and replacing components, and a replacement parts list. It also includes contact information for product support and technical information.
- Chapter 8 “System Description” describes the function and location of the system components, provides an overview of the software structure, and includes a description of the system electronics and input/output connections.
- Chapter 9 “Optional Equipment” describes the optional equipment that can be used with this instrument.
- Appendix A “Warranty” provides a copy of the warranty statement.

- Appendix B “C-Link Protocol Commands” provides a description of the C-Link protocol commands that can be used to remotely control an analyzer using a host device such as a PC or a datalogger.
- Appendix C “MODBUS Protocol” provides a description of the MODBUS Protocol Interface and is supported both over RS-232/485 (RTU protocol) as well as TCP/IP over Ethernet.





Safety

Review the following safety information carefully before using the analyzer. This manual provides specific information on how to operate the analyzer, however if the analyzer is used in a manner not specified by the manufacturer, the protection provided by the equipment may be impaired.



Safety and Equipment Damage Alerts

This manual contains important information to alert you to potential safety hazards and risks of equipment damage. Refer to the following types of alerts you may see and the actual alerts that appear in this manual.

Safety and Equipment Damage Alert Descriptions

Alert	Description
 DANGER	A hazard is present that will result in death or serious personal injury if the warning is ignored. ▲
 WARNING	A hazard is present or an unsafe practice can result in serious personal injury if the warning is ignored. ▲
 CAUTION	The hazard or unsafe practice could result in minor to moderate personal injury if the warning is ignored. ▲
 Equipment Damage	The hazard or unsafe practice could result in property damage if the warning is ignored. ▲

Safety and Equipment Damage Alerts in this Manual

Alert	Description
	<p>WARNING</p> <p>If the equipment is operated in a manner not specified by the manufacturer, the protection provided by the equipment may be impaired. ▲</p> <p>The service procedures in this manual are restricted to qualified service personnel only. ▲</p> <p>The Model 42i High Level is supplied with a three-wire grounding cord. Under no circumstances should this grounding system be defeated. ▲</p>
	<p>CAUTION</p> <p>If the LCD panel breaks, do not to let the liquid crystal contact your skin or clothes. If the liquid crystal contacts your skin or clothes, wash it off immediately using soap and water. ▲</p> <p>Avoid contact with converter heated components. Allow converter to cool to room temperature before handling converter components. ▲</p>
	<p>Equipment Damage</p> <p>Do not attempt to lift the instrument by the cover or other external fittings. ▲</p> <p>Some internal components can be damaged by small amounts of static electricity. A properly grounded antistatic wrist strap must be worn while handling any internal component. ▲</p> <p>Handle all printed circuit boards by the edges only. ▲</p> <p>Do not point the photomultiplier tube at a light source. This can permanently damage the tube. ▲</p> <p>Do not remove the panel or frame from the LCD module. ▲</p> <p>The LCD module polarizing plate is very fragile, handle it carefully. ▲</p> <p>Do not wipe the LCD module polarizing plate with a dry cloth, it may easily scratch the plate. ▲</p> <p>Do not use alcohol, acetone, MEK or other Ketone based or aromatic solvents to clean the module, use a soft cloth moistened with a naphtha cleaning solvent. ▲</p> <p>Do not place the LCD module near organic solvents or corrosive gases. ▲</p> <p>Do not shake or jolt the LCD module. ▲</p>

WEEE Symbol

The following symbol and description identify the WEEE marking used on the instrument and in the associated documentation.

Symbol	Description
	Marking of electrical and electronic equipment which applies to electrical and electronic equipment falling under the Directive 2002/96/EC (WEEE) and the equipment that has been put on the market after 13 August 2005.

Where to Get Help

Service is available from exclusive distributors worldwide. Contact one of the phone numbers below for product support and technical information or visit us on the web at www.thermo.com/aqi.

1-866-282-0430 Toll Free

1-508-520-0430 International

Chapter 1 Introduction

The Model 42*i* High Level Chemiluminescence NO-NO₂-NO_x Analyzer combines proven detection technology, easy to use menu-driven software, and advanced diagnostics to offer unsurpassed flexibility and reliability. The Model 42*i* High Level has the following features:

- 320 x 240 graphics display
- Menu-driven software
- Field programmable ranges
- User-selectable single/dual/auto range modes
- Multiple user-defined analog outputs
- Analog input options
- High sensitivity
- Fast response time
- Linearity through all ranges
- Independent NO-NO₂-NO_x ranges
- Replaceable NO₂ converter cartridge
- User-selectable digital input/output capabilities
- Standard communications features include RS232/485 and Ethernet
- C-Link, MODBUS, and streaming data protocols

For details of the analyzer's principle of operation and product specifications, see the following topics:

- “[Principle of Operation](#)” on [page 1-2](#) describes the principles by which your analyzer operates.

- “Specifications” on page 1-3 is a list of the analyzer’s performance specifications.

Thermo Fisher Scientific is pleased to supply this chemiluminescence NO-NO₂-NO_x analyzer. We are committed to the manufacture of instruments exhibiting high standards of quality, performance, and workmanship. Service personnel are available for assistance with any questions or problems that may arise in the use of this analyzer. For more information on servicing, see Chapter 7, “Servicing”.

Principle of Operation

The Model 42i High Level operates on the principle that nitric oxide (NO) and ozone (O₃) react to produce a characteristic luminescence with an intensity linearly proportional to the NO concentration. Infrared light emission results when electronically excited NO₂ molecules decay to lower energy states. Specifically,



Nitrogen dioxide (NO₂) must first be transformed into NO before it can be measured using the chemiluminescent reaction. NO₂ is converted to NO by a stainless steel NO₂-to-NO converter heated to about 625 °C (the optional molybdenum converter is heated to 325 °C).

The ambient air sample is drawn into the Model 42i High Level through the *sample* bulkhead, as shown in Figure 1-1. The sample flows through a capillary, and then to the mode solenoid valve. The solenoid valve routes the sample either straight to the reaction chamber (NO mode) or through the NO₂-to-NO converter and then to the reaction chamber (NO_x mode). A flow sensor prior to the reaction chamber measures the sample flow.

Dry air enters the Model 42i High Level through the *dry air* bulkhead, passes through a flow switch, and then through a silent discharge ozonator. The ozonator generates the ozone needed for the chemiluminescent reaction. At the reaction chamber, the ozone reacts with the NO in the sample to produce excited NO₂ molecules. A photomultiplier tube (PMT) housed in a thermoelectric cooler detects the luminescence generated during this reaction. From the reaction chamber, the exhaust travels through the ozone (O₃) converter to the pump, and is released through the vent.

The NO and NO_x concentrations calculated in the NO and NO_x modes are stored in memory. The difference between the concentrations is used to calculate the NO₂ concentration. The Model 42i High Level outputs NO,

NO₂, and NO_x concentrations to the front panel display, the analog outputs, and also makes the data available over the serial or ethernet connection.

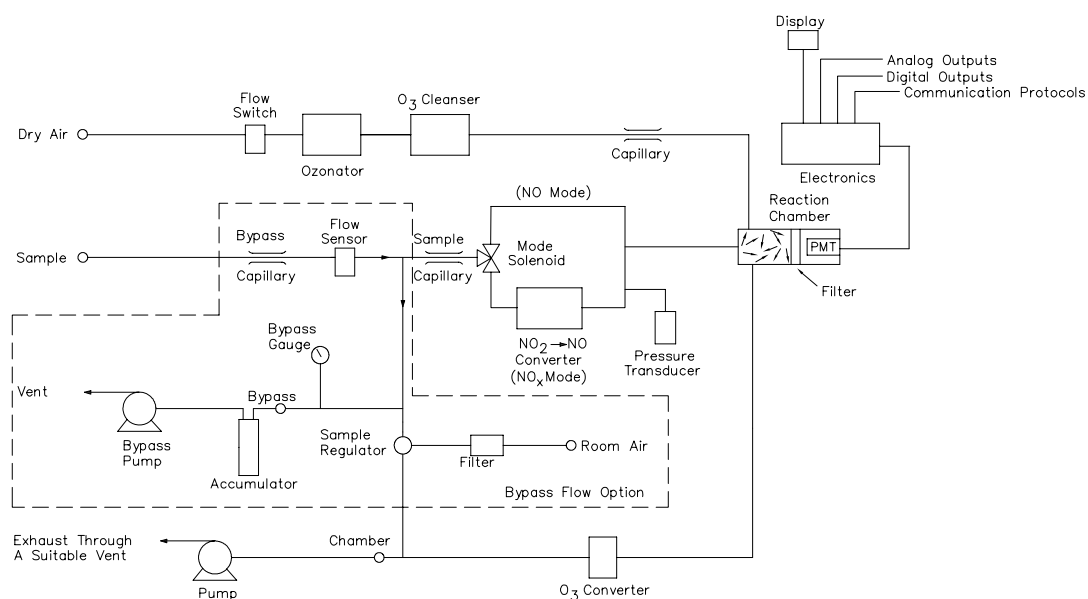

Figure 1-1. Model 42i High Level Flow Schematic (shown with bypass flow option)

Specifications

Table 1-1. Model 42i High Level Specifications

Preset ranges	0-10, 20, 50, 100, 200, 500, 1000, 2000, 5000 ppm 0-20, 50, 100, 200, 500, 1000, 2000, 5000, 7500 mg/m ³
Custom ranges	0-10 to 5000 ppm 0-20 to 7500 mg/m ³
Zero noise	0.025 ppm
Lower detectable limit	0.050 ppm
Zero drift (24 hour)	0.050 ppm
Span drift (24 hour)	± 1% full-scale
Response time (in manual mode)	2.5 seconds NO 5.0 seconds NO _x
Vacuum	28.5" Hg
Linearity	± 1% full-scale
Sample flow rate	25 cc/min.
Bypass flow rate (option)	250–1100 cc/min.

Operating temperature	15–35 °C (may be safely operated over the range of 0–45 °C)*
Power requirements	100 VAC @ 50/60 Hz 115 VAC @ 50/60 Hz 220–240 VAC @ 50/60 Hz 500 watts
Physical dimensions	16.75" (W) X 8.62" (H) X 23" (D)
Weight	Approximately 70 lbs. (including external pump)
Analog outputs	6 voltage outputs; 0–100 mV, 1 V, 5 V, 10 V (User selectable), 5% of full-scale over/under range, 12 bit resolution, user selectable for measurement input
Digital outputs	1 power fail relay Form C, 10 digital relays Form A, user selectable alarm output, relay logic, 100 mA @ 200 VDC
Digital inputs	16 digital inputs, user select programmable, TTL level, pulled high
Serial Ports	1 RS-232 or RS-485 with two connectors, baud rate 1200–115200, data bits, parity, and stop bits, protocols: C-Link, MODBUS, and streaming data (all user selectable)
Ethernet connection	RJ45 connector for 10Mbps Ethernet connection, static or dynamic TCP/IP addressing

* In non condensing environments. Performance specifications based on operation in 15–35 °C range.

Chapter 2 Installation

Installing the Model 42i High Level includes the following recommendations and procedures:

- “Lifting” on page 2-1
- “Unpacking and Inspection” on page 2-1
- “Setup Procedure” on page 2-2
- “Startup” on page 2-5

Lifting

When lifting the instrument, use procedure appropriate to lifting a heavy object, such as, bending at the knees while keeping your back straight and upright. Grasp the instrument at the bottom in the front and at the rear of the unit. Although one person can lift the unit, it is desirable to have two persons lifting, one by grasping the bottom in the front and the other by grasping the bottom in the rear.



Equipment Damage Do not attempt to lift the instrument by the cover or other external fittings. ▲

Unpacking and Inspection

The Model 42i High Level is shipped in two containers. If there is obvious damage to the shipping container when you receive the instrument, notify the carrier immediately and hold for inspection. The carrier is responsible for any damage incurred during shipment.

Use the following procedure to unpack and inspect the instrument.

1. Remove the instrument from the shipping container and place it on a table or bench that allows easy access to both the front and rear.
2. Remove the cover to expose the internal components.

3. Remove any packing material.
4. Check for possible damage during shipment.
5. Check that all connectors and circuit boards are firmly attached.
6. Re-install the cover.

Setup Procedure

Use the following procedure to setup the instrument.

1. Connect the sample line to the SAMPLE bulkhead on the rear panel (Figure 2-1). Ensure that the sample line is not contaminated by dirty, wet, or incompatible materials. All tubing should be constructed of FEP Teflon®, 316 stainless steel, borosilicate glass, or similar tubing with an OD of 1/4-inch and a minimum ID of 1/8-inch. The length of the tubing should be less than 10 feet.

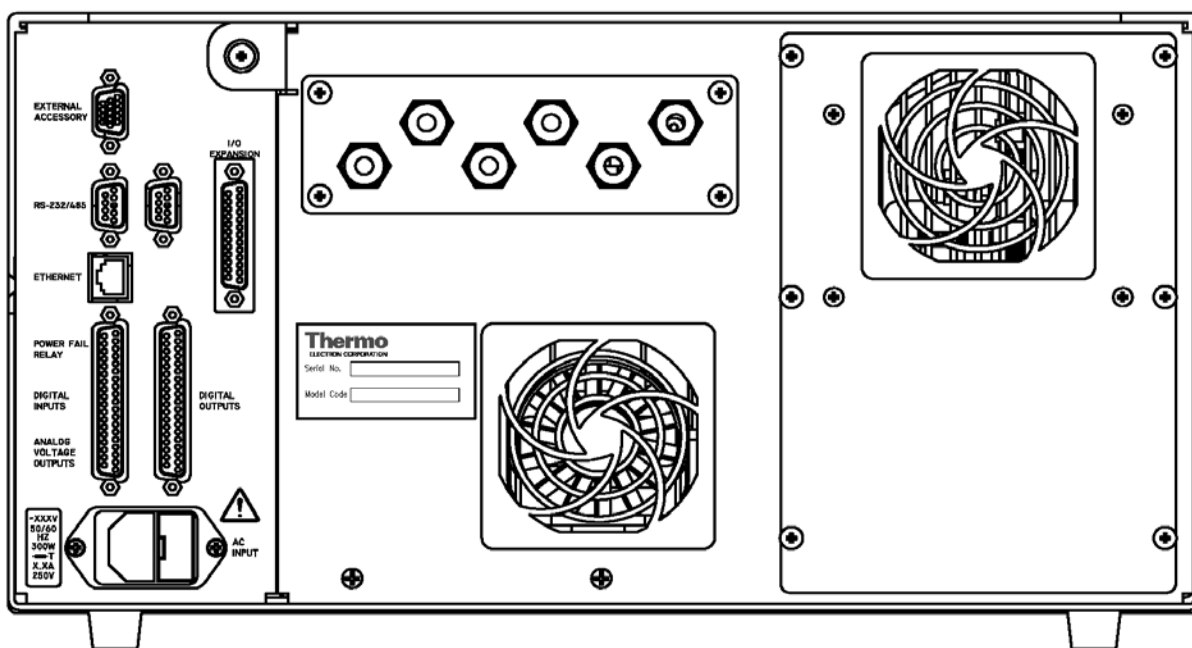

Figure 2-1. Model 42i High Level Rear Panel

Note Gas must be delivered to the instrument at atmospheric pressure. It may be necessary to use an atmospheric bypass plumbing arrangement as shown in [Figure 2-2](#) if gas pressure is greater than atmospheric pressure. ▲

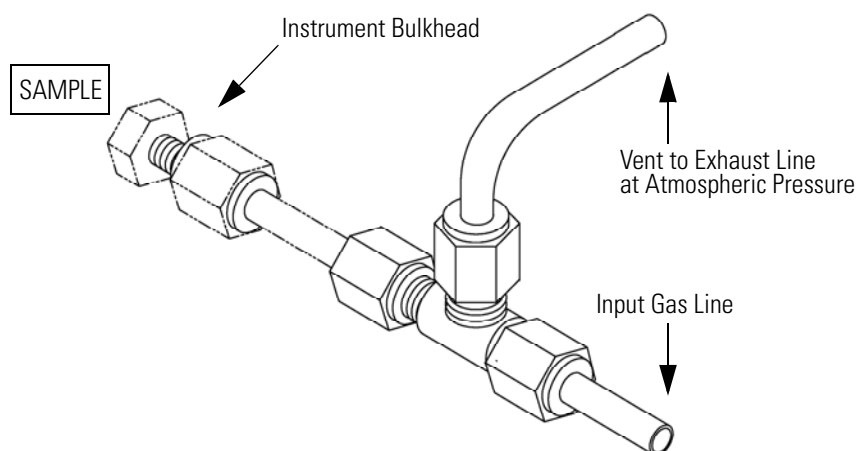

Figure 2-2. Atmospheric Dump Bypass Plumbing

2. Connect the air dryer to the DRY AIR bulkhead.
3. Connect the pump vacuum port (inlet) to the CHAMBER bulkhead ([Figure 2-3](#)).



Equipment Damage DO NOT connect the pump exhaust port to the CHAMBER bulkhead. This can cause permanent damage to both the cooler and the photomultiplier tube. ▲

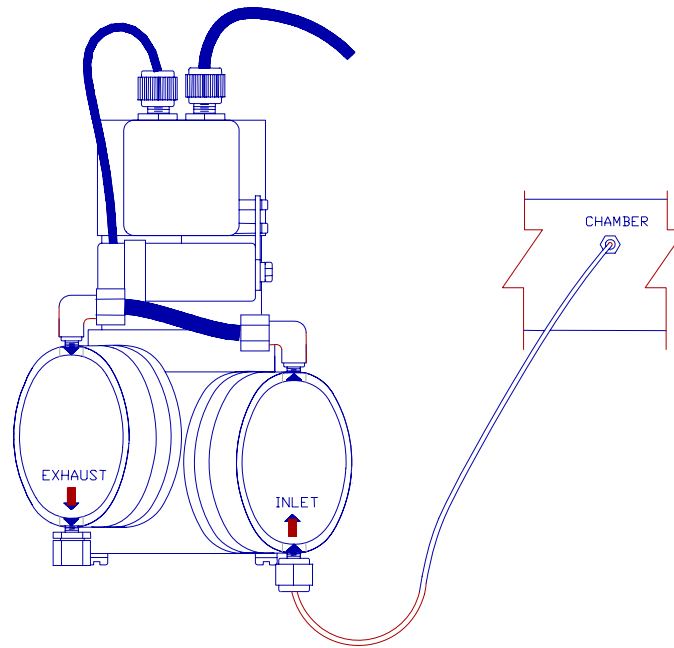

Figure 2-3. Twin-Head Vacuum Pump Installation

4. Connect the pump exhaust to a suitable vent or ozone scrubber.

Note The exhaust line used to connect the pump to the instrument should be 1/4-inch OD with a minimum ID of 1/8-inch. The length of the exhaust line should be less than 10 feet. Verify that there is no restriction in this line.



5. Plug the pump into an outlet of the appropriate voltage and frequency.
6. If the instrument is equipped with a bypass pump, connect the BYPASS chamber to the accumulator and connect the accumulator to the bypass inlet.
7. Connect the bypass pump exhaust to a suitable vent or ozone scrubber.

8. Connect a suitable recording device to the rear panel connector. See the “Operation” chapter for more information about the rear panel pin-outs.



WARNING This instrument is supplied with a three-wire grounding cord. DO NOT alter this grounding system under any circumstances. ▲

9. Plug the instrument into an outlet of the appropriate voltage and frequency.

Startup

Use the following procedure when starting the instrument.

Note It is best to turn the ozonator on and let the instrument run overnight before calibration in order to obtain the most accurate results. ▲

1. Plug the sample pump and the bypass pump (if the bypass flow option is installed) into an appropriate AC outlet.
2. Turn the power ON.
3. Allow 90 minutes for the instrument to stabilize.
4. Set instrument parameters such as operating ranges and averaging times to appropriate settings. For more information about instrument parameters, see the “Operation” chapter.
5. Before beginning actual monitoring, perform a multipoint calibration as described in the “Calibration” chapter.

Installation



Startup

Chapter 3 Operation

This chapter describes the front panel display, front panel pushbuttons, and menu-driven software.

- “Display” on [page 3-2](#) describes the LCD graphics display.
- “Pushbuttons” on [page 3-3](#) describes the various front panel pushbuttons and the expected key actions for each.
- “Software Overview” on [page 3-4](#) describes the menu-driven software and submenus.
- “Range Menu” on [page 3-8](#) describes the gas units, NO- NO₂ -NO_x ranges, and custom ranges.
- “Averaging Time” on [page 3-17](#) describes the averaging period applied to NO, NO₂, and NO_x measurements.
- “Calibration Factors Menu” on [page 3-18](#) describes the calibration factors used to correct NO, NO₂, and NO_x measurement readings.
- “Calibration Menu” on [page 3-22](#) describes calibration of zero and span.
- “Instrument Controls Menu” on [page 3-29](#) describes the instrument hardware control and configuration.
- “Diagnostics Menu” on [page 3-64](#) describes the diagnostic information and functions.
- “Alarms Menu” on [page 3-72](#) describes a list of items that are monitored by the analyzer.
- “Service Menu” on [page 3-82](#) describes service related menu items.
- “Password” on [page 3-98](#) describes how to enter/change a password, lock and unlock the instrument.

Display

The 320 x 240 graphics liquid-crystal display (LCD) shows the sample concentrations, instrument parameters, instrument controls, help, and error messages. Some menus contain more items than can be displayed at one time. For these menus, use  and  to move the cursor up and down to each item.

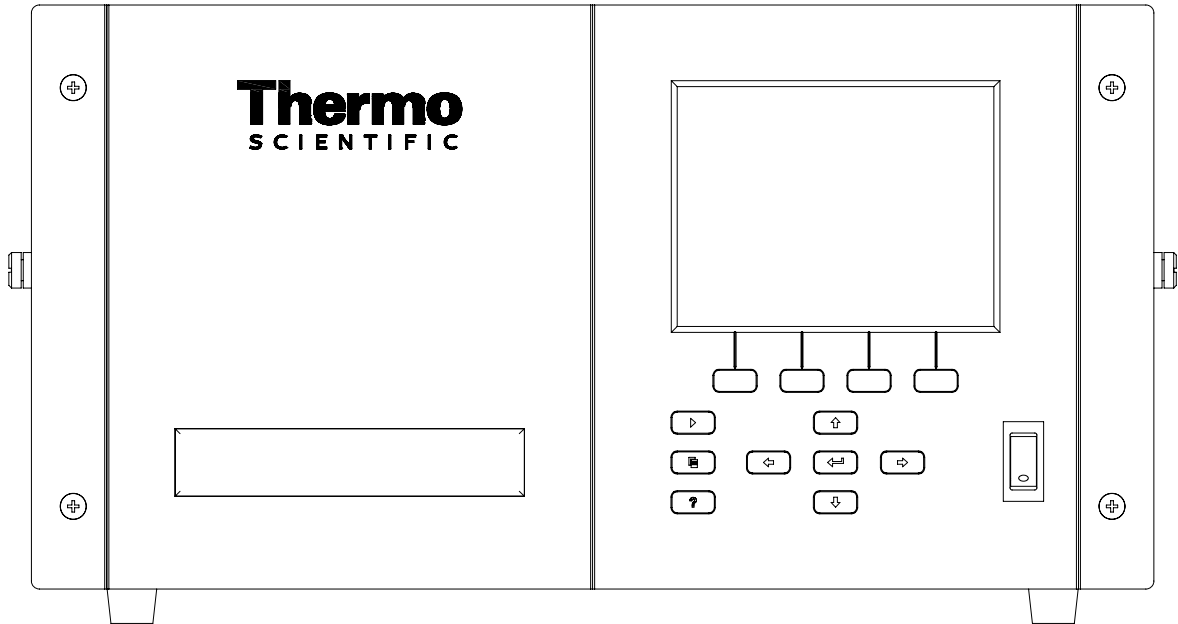

Figure 3-1. 42i High Level Front Panel Display



CAUTION If the LCD panel breaks, do not let the liquid crystal contact your skin or clothes. If the liquid crystal contacts your skin or clothes, wash it off immediately using soap and water. ▲

Pushbuttons

The Pushbuttons allow the user to traverse the various screens/menus.

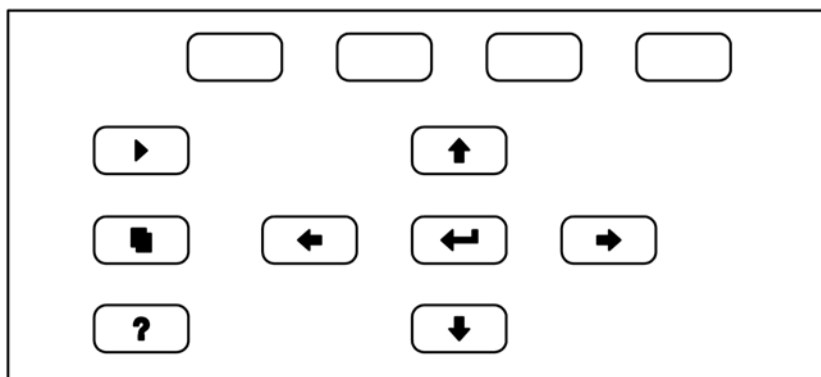

























Figure 3-2. Front Panel Pushbuttons

Table 3-1. Front Panel Pushbuttons

 = Soft Keys	The  soft keys are used to provide shortcuts that allow the user to jump to user-selectable menu screens. For more information on processing soft keys, see “Soft Keys” below.
 = Run	The  is used to display the Run screen. The Run screen normally displays the NO, NO ₂ , and NO _x concentrations.
 = Menu	The  is used to display the Main Menu when in the Run screen, or back up one level in the menu system. For more information about the Main Menu, see “Main Menu” later in this chapter.
 = Help	The  is context-sensitive, that is, it provides additional information about the screen that is being displayed. Press  for a brief explanation about the current screen or menu. Help messages are displayed using lower case letters to easily distinguish them from the operating screens. To exit a help screen, press  or  to return to the previous screen, or  to return to the Run screen.
  = Up, Down   = Left, Right	The four arrow pushbuttons ( ,  ,  , and ) move the cursor up, down, left, and right or change values and states in specific screens.
 = Enter	The  is used to select a menu item, accept/set/save a change, and/or toggle on/off functions.

Soft Keys

The Soft Keys are multi-functional keys that use part of the display to identify their function at any moment. The function of the soft keys allow immediate access to the menu structure and most often used menus and screens. They are located directly underneath the display and as the keys' functions change this is indicated by user-defined labels in the lower part of the display, so that the user knows what the keys are to be used for.

To change a soft key, place the menu cursor ">" on the item of the selected menu or screen you wish to set. Press  followed by the selected soft key within 1 second of pressing the right-arrow key. The edit soft key prompt will be displayed for configuration for the new label.

Note Not all menu items may be assigned to soft keys. If a particular menu or screen item cannot be assigned, the key assignment screen will not come up upon entering right-arrow-soft key combinations. All items under the Service menu (including the menu itself) cannot be assigned soft keys. ▲



Software Overview

The Model 42i High Level utilizes the menu-driven software illustrated by the flowchart in [Figure 3-3](#). The Power-Up screen, shown at the top of the flowchart, is displayed each time the instrument is turned on. This screen is displayed while the instrument is warming up and performing self-checks. After the warm-up period, the Run screen is automatically displayed. The Run screen is the normal operating screen. It displays the NO, NO₂, and NO_x concentrations, depending on operating mode. From the Run screen, the Main Menu can be displayed by pressing . The Main Menu contains a list of submenus. Each submenu contains related instrument parameters and/or functions. This chapter describes each submenu and screen in detail. Refer to the appropriate sections for more information.

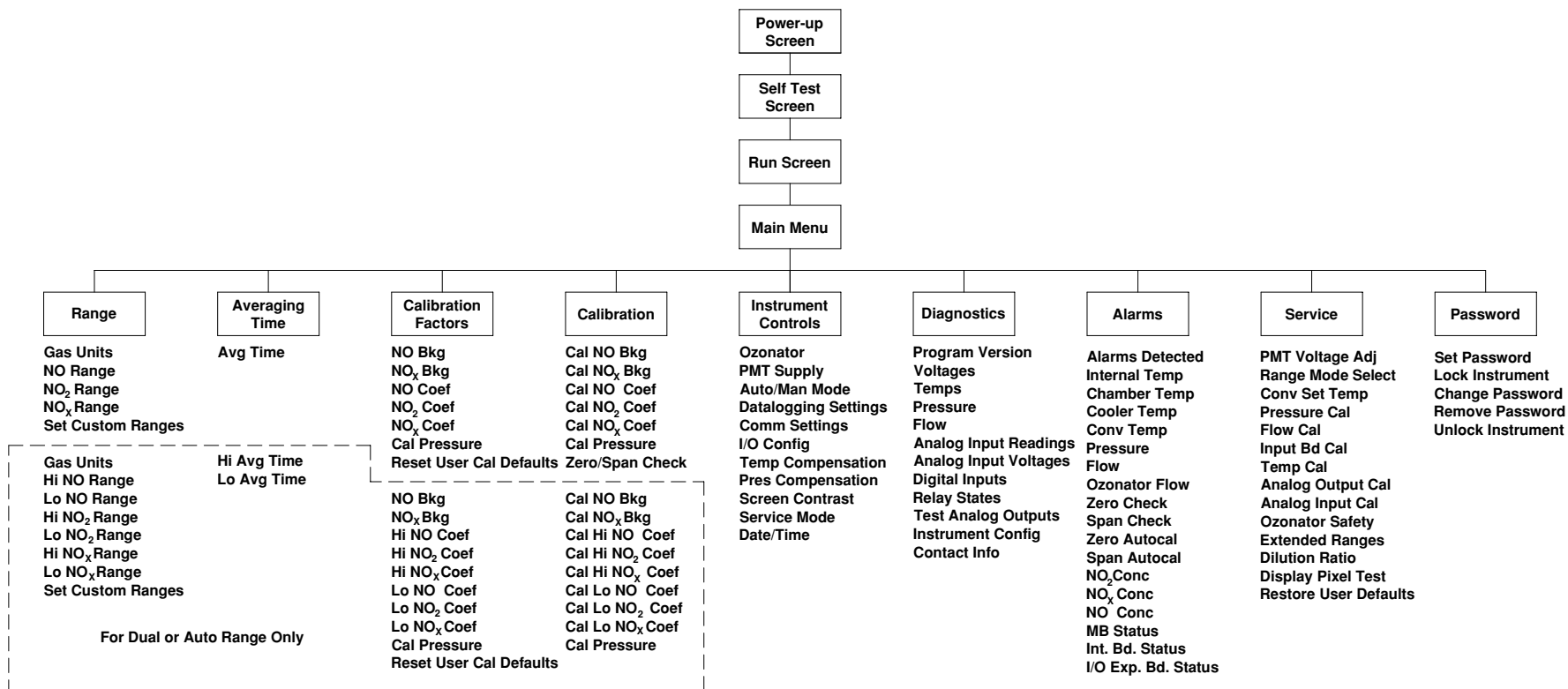

Figure 3-3. Flowchart of Menu-Driven Software



Power-Up Screen

The Power-Up screen is displayed on power up of the Model 42*i* High Level. The Self-Test is displayed while the internal components are warming up and diagnostic checks are performed.



Run Screen





The Run screen displays the NO, NO₂, and NO_x concentrations. The status bar displays time and the status of the remote control interface, and optional zero/span solenoid valves, if installed. The word "SAMPLE" on the bottom left of the display indicates the analyzer has the span/zero valve option and is in "SAMPLE" mode. Other modes appear in the same area of the display as "ZERO" or "SPAN". For more information about the optional solenoid valves, see Chapter 9, "Optional Equipment".

When operating in dual or auto range mode, two sets of coefficients are used to calculate the NO-NO₂-NO_x "LOW" and "HIGH" concentrations. Also, two averaging times are used—one for each range. The title bar indicates which range concentrations are displayed. The words "LOW RANGE CONCENTRATION" on the top of the display indicates that the low concentration is displayed. The display shows as default the low concentrations. In dual range mode, pressing the  and  arrows will toggle between high and low concentrations. The example below shows the Run screen in single range mode.

CONCENTRATION	
NO	62.7 PPM
NO ₂	25.5 PPM
NO _x	88.2 PPM
SAMPLE	12:34
RANGE	AVG
DIAGS	ALARM

Main Menu

The Main Menu contains a number of submenus. Instrument parameters and features are divided into these submenus according to their function. The concentration appears above the main menu and submenus in every screen, as shown below. The Service menu is visible only when the instrument is in service mode. For more information on the service mode, see “Service Mode” later in this chapter.

- Use  and  to move the cursor up and down.
- Press  to select a choice.
- Press  to return to the Run screen.

CONCENTRATION	
NO	62.7 PPM
NO ₂	25.5 PPM
NO _x	88.2 PPM
SAMPLE	12:34
MAIN MENU:	
>RANGE	
AVERAGING TIME	
CALIBRATION FACTORS	
CALIBRATION	
INSTRUMENT CONTROLS	
DIAGNOSTICS	
ALARMS	↓
RANGE	AVG
DIAGS	ALARM

SERVICE
PASSWORD

Range Menu

The Range menu allows the operator to select the gas units, NO-NO₂-NO_x ranges, and to set the custom ranges. The screens below show the range menu in single range mode and dual/auto range modes. For more information about the single, dual, and auto range modes, see “Single Range Mode”, “Dual Range Mode”, and “Auto Range Mode” below.

- In the Main Menu, choose **Range**.

```
RANGE:
>GAS UNITS          PPM
NO RANGE            50
NO2 RANGE           50
NOx RANGE           50
SET CUSTOM RANGES

RANGE  AVG  DIAGS  ALARM
```

```
RANGE:
>GAS UNITS          PPM
HI NO RANGE        100
LO NO RANGE         50
HI NO2 RANGE       100
LO NO2 RANGE        50
HI NOx RANGE       100
LO NOx RANGE        50 ↓

RANGE  AVG  DIAGS  ALARM
```

SET CUSTOM RANGES

Single Range Mode

In the single range mode, the NO, NO₂, and NO_x channels each have one range, one averaging time, and one span coefficient.

By default, the three analog outputs are arranged on the rear panel connector as shown in [Figure 3-4](#). See [Table 3-2](#) for channels and pin connections. Single range mode may be selected from the “Single/Dual/Auto Select” in the “Service Menu”, later in this chapter.

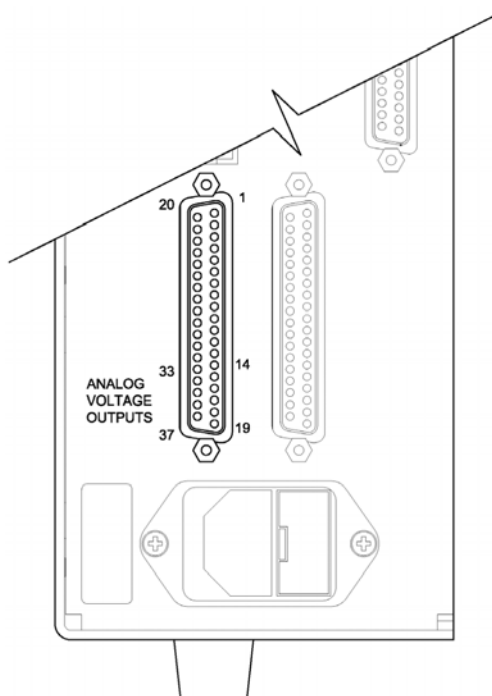

Figure 3-4. Pin-Out of Rear Panel Connector in Single Range Mode

Table 3-2. Default Analog Outputs in Single Range Mode

Channel	Pin	Description
1	14	NO Analog Output
2	33	NO ₂ Analog Output
3	15	NO _x Analog Output
4	34	None
5	17	None
6	36	None
Ground	16, 18, 19, 35, 37	Signal Ground

Note All channels are user definable. If any customization has been made to the analog output configuration, the default selections may not apply. ▲

Dual Range Mode

In the dual range mode, there are two independent channels defined for each compound being measured. These are labeled simply as the “High Range” and the “Low Range”. Each channel has its own analog output range, averaging time and span coefficient.

This enables the sample concentration readings to be sent to the analog outputs using two different ranges. For example, the low NO analog output can be set to output concentrations from 0 to 50 ppm and the high NO analog output set to output concentrations from 0 to 100 ppm.

In addition to each channel having two ranges, each channel has two span coefficients. There are two span coefficients so that each range can be calibrated separately. This is necessary if the two ranges are not close to one another. For example, if the low NO range is set to 0–50 ppm and the high NO range is set to 0–1,000 ppm.

By default, in the dual range mode, the analog outputs are arranged on the rear panel connector as shown in [Figure 3-5](#). See [Table 3-3](#) for channels and pin connections. Dual range mode may be selected from the “Single/Dual/Auto Select” in the “Service Menu”, later in this chapter.

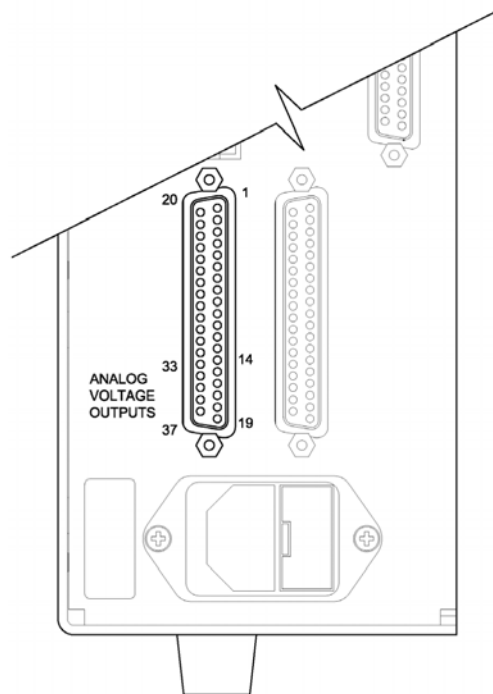

Figure 3-5. Pin-Out of Rear Panel Connector in Dual Range Mode

Table 3-3. Default Analog Outputs in Dual Range Mode

Channel	Pin	Description
1	14	NO High Range
2	33	NO ₂ High Range
3	15	NO _x High Range
4	34	NO Low Range
5	17	NO ₂ Low Range
6	36	NO _x Low Range
Ground	16, 18, 19, 35, 37	Signal Ground

Note All channels are user definable. If any customization has been made to the analog output configuration, the default selections may not apply. ▲

Auto Range Mode

The auto range mode switches the NO, NO₂ and NO_x analog outputs between high and low ranges, depending on the NO_x concentration level, except when continuous NO mode is active. The high and low ranges are defined in the Range menu.

For example, suppose the low ranges are set to 50 ppm and the high ranges are set to 100 ppm (Figure 3-6). Sample concentrations below 50 ppm are presented to the low ranges analog outputs and sample concentrations above 50 ppm are presented to the high ranges analog outputs. When the low ranges are active, the status output is at 0 volts. When the high ranges are active, the status output is at half of full-scale.

When the high ranges are active, the NO_x concentration must drop to 95% of the low NO_x range for the low ranges to become active.

In addition to each channel having two ranges, each channel has two span coefficients. There are two span coefficients so that each range can be calibrated separately. This is necessary if the two ranges are not close to one another. For example, if the low NO range is set to 0–50 ppm and the high NO range is set to 0–1,000 ppm.

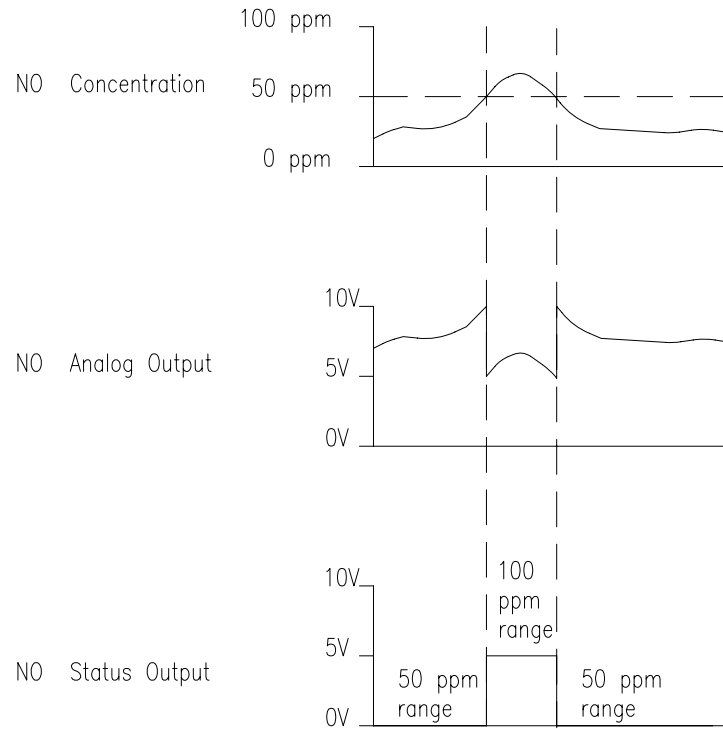

Figure 3-6. Analog Output in Auto Range Mode

By default, in the auto range mode, the analog outputs are arranged on the rear panel connector as shown in [Figure 3-7](#). See [Table 3-4](#) for channels and pin connections. Auto range mode may be selected from the “Single/Dual/Auto Select” in the “Service Menu”, later in this chapter.

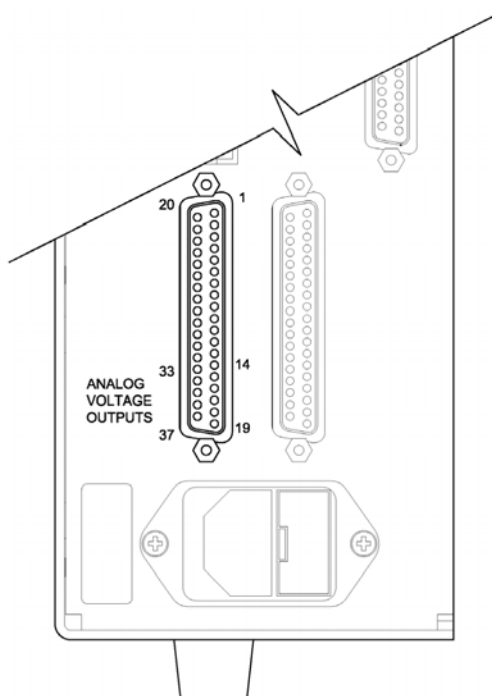

Figure 3-7. Pin-Out of Rear Panel Connector in Auto Range Mode

Table 3-4. Default Analog Outputs in Auto Range Mode



Channel	Pin	Description
1	14	NO Analog Output
2	33	NO ₂ Analog Output
3	15	NO _x Analog Output
4	34	Range Status: half scale = high range zero scale = low range
5	17	None
6	36	None
Ground	16, 18, 19, 35, 37	Signal Ground

Note All channels are user definable. If any customization has been made to the analog output configuration, the default selections may not apply. ▲

Gas Units

The Gas Units screen defines how the NO, NO₂ and NO_x concentration readings are expressed. Gas units of parts per million (ppm) and milligrams per cubic meter (mg/m³) are available. The mg/m³ gas concentration mode is calculated using a standard pressure of 760 mmHg and a standard temperature of 20 °C.

When switching the selected units from ppm to mg/m³, the analog ranges all default to the highest range in that mode. For example, when switching from mg/m³ to ppm, all the ranges default to 5,000 ppm. Therefore, whenever you change units, you should also check the range settings.

- In the Main Menu, choose Range > **Gas Units**.
- Use  and  to scroll through a list of choices.
- Press  to save the new units.

Note If the units change from ppm to mg/m³ or vice-versa, the instrument should be recalculated, particularly if the user's standard temperature is different from 20 °C. A display warning will appear that ranges will be defaulted and calibration parameters reset. ▲

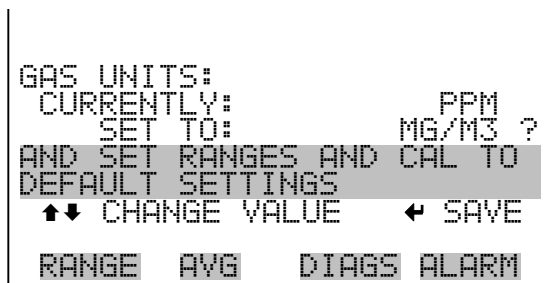



NO, NO₂, and NO_x Ranges

The NO, NO₂, and NO_x Ranges define the concentration range of the analog outputs. For example, an NO₂ range of 0–50 ppm restricts the NO₂ analog output to concentrations between 0 and 50 ppm.

The display shows the current NO, NO₂, or NO_x range. The next line of the display is used to change the range. The range screen is similar for the single, dual, and auto range modes. The only difference between the screens are the words “High” and “Low” to indicate which range is displayed. The example below shows the NO range screen in single mode. For more

information about the single, dual, and auto range modes, see “Single Range Mode”, “Dual Range Mode”, and “Auto Range Mode” earlier in this chapter.

Table 3-5 lists the available ranges.

- In the Main Menu, choose Range > NO, NO₂, or NO_x Range.
- Use  and  to scroll through a list of choices.
- Press  to save the new range.

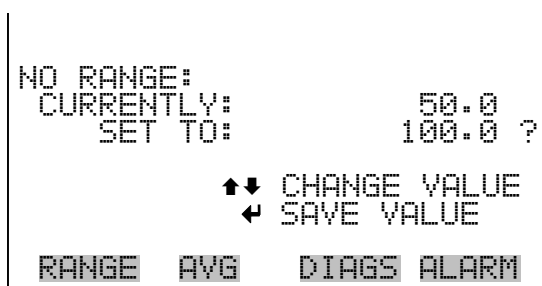

Table 3-5. Operating Ranges

ppm	mg/m ³
10	20
20	50
50	100
100	200
200	500
500	1,000
1,000	2,000
2,000	5,000
5,000	7,500
C1	C1
C2	C2
C3	C3

C1, C2, and C3 are custom ranges. For more information about custom ranges, see “Set Custom Ranges” below.

Set Custom Ranges

The Set Custom Ranges menu lists three custom ranges: C1, C2, and C3. Custom ranges are user-defined ranges. In the ppm mode, any value between 10 and 5,000 ppm can be specified as a range. In the mg/m³ mode, any value between 20 and 7,500 mg/m³ can be specified as a range.

- In the Main Menu, choose Range > **Set Custom Ranges**.



```
CUSTOM RANGES:
>CUSTOM RANGE 1      55.6
CUSTOM RANGE 2      75.0
CUSTOM RANGE 3     125.0

RANGE  AVG  DIAGS  ALARM
```

Custom Ranges

The Custom Ranges screen is used to define the custom ranges.

The display shows the current custom range. The next line of the display is used to set the range. To use the custom full-scale range, be sure to select it (Custom range 1, 2, or 3) in the NO, NO₂, or NO_x Range screen. For more information about selecting ranges, see “NO, NO₂, and NO_x Ranges” above.

- In the Main Menu, choose Range > Set Custom Ranges > **Custom range 1, 2, or 3**.
- Use  and  to increment or decrement the numeric value.
- Press  to save the new range.

```
CUSTOM RANGE 1:
CURRENTLY:      55.6
SET TO:        000055.7 ?



      ↔ MOVE CURSOR
↑↓ CHANGE VALUE  ← SAVE

RANGE  AVG  DIAGS  ALARM
```

Averaging Time

The averaging time defines a time period (10 to 300 seconds) over which NO, NO₂, and NO_x measurements are averaged. The average concentration of the NO, NO₂, and NO_x readings are calculated for that time period. The front panel display and analog outputs are updated every 10 seconds with the calculated averages. An averaging time of 10 seconds, for example, means that the average concentration of the last 10 seconds will be output at each update. An averaging time of 300 seconds means that the moving average concentration of the last 300 seconds will be output at each 10-second update. Therefore, the lower the averaging time, the faster the front panel display and analog outputs respond to concentration changes. Longer averaging times are typically used to smooth output data.

The Averaging Time screen for the single range mode is shown below. In the dual and auto range modes, an averaging time menu is displayed before the averaging time screen. This additional menu is needed because dual and auto range modes have two averaging times (high and low). The averaging time screens function the same way in the single, dual and auto range modes. The following averaging times are available: 10, 20, 30, 60, 90, 120, 180, 240, and 300 seconds. Additional averaging times are available in manual NO and manual NO_x modes: 1, 2, and 5 seconds. For more information about the manual mode, see “Auto/Manual Mode” later in this chapter.

- In the Main Menu, choose **Averaging Time**.
- Use  and  to scroll through a list of choices.
- Press  to save the averaging time.

```

AVERAGING TIME:
CURRENTLY:      30 SEC
SET TO:        10 SEC ?

      ↑↓ CHANGE VALUE
      ←  SAVE VALUE

RANGE  AVG  DIAGS  ALARM
  
```

Calibration Factors Menu

Calibration factors are used to correct the NO, NO₂, and NO_x concentration readings that the instrument generates using its own internal calibration data. The Calibration Factors menu displays the calibration factors. The screens below show the calibration factors menu in single mode and dual/auto range modes.

Normally, the instrument is calibrated automatically using the commands listed in the Calibration menu described later in this chapter. However, the instrument can also be calibrated manually using the Calibration Factors menu.

To manually calibrate the instrument, see “NO and NO_x Backgrounds”, “NO, NO₂, and NO_x Span Coefficients”, and “Calibration Pressure” below.

- In the Main Menu, choose **Calibration Factors**.

```
CALIBRATION FACTORS:
>NO BKG          0.0
NOx BKG          0.0
NO COEF          1.000
NO2 COEF         1.000
NOx COEF         1.000
CAL PRESSURE     35.0 mmHg
RESET USER CAL DEFAULTS

RANGE  AVG  DIAGS  ALARM
```

```
CALIBRATION FACTORS:
>NO BKG          0.0
NOx BKG          0.0
HI NO COEF       1.000
HI NO2COEF       1.000
HI NOx COEF      1.000
LO NO COEF       1.000
LO NO2 COEF      1.000↓

RANGE  AVG  DIAGS  ALARM
```







```
LO NOx COEF      1.000
CAL PRESSURE     35.0 mmHg
RESET USER CAL DEFAULTS
```



NO and NO_x Backgrounds

The NO and NO_x background corrections are determined during zero calibration. The NO background is the amount of signal read by the analyzer in the NO channel while sampling zero air. The NO_x background is the amount of signal read by the analyzer in the NO_x channel while sampling zero air. Although the background is expressed in terms of concentration, the background signal is actually the combination of electrical offsets, PMT dark current, and trace substances undergoing chemiluminescence. Before the analyzer sets the NO and NO_x readings to zero, it stores these values as the NO and NO_x background corrections, respectively. The NO₂ background correction is determined from the NO and NO_x background corrections and is not displayed. NO and NO_x background corrections are typically below 0.030 ppm.

The NO and NO_x Background screens are used to perform a manual adjustment of the instruments zero background. Before performing a background adjustment, allow the analyzer to sample zero air until stable readings are obtained. The NO channel should be adjusted first. Both the NO and NO_x Background screens operate the same way. Therefore, the following description of the NO background screen applies to the NO_x background screen as well. The first line of the display shows the current NO reading. The second line of the display shows the NO background correction that is stored in memory. The NO background correction is a value, expressed in the current gas units, that is subtracted from the NO reading to produce the NO reading that is displayed.

In the example below, the analyzer is displaying .44 ppm of NO while sampling zero air. A background correction of 0.0 ppm means that 0 ppm is being subtracted from the NO concentration being displayed. Therefore the background correction must be increased to .44 ppm in order for the NO reading to be at 0 ppm, i.e., a NO reading of .44 ppm minus a NO background reading of .44 ppm gives the corrected NO reading of 0 ppm.

To set the NO reading in the example below to zero, use  to increment the NO background correction to .44 ppm. As the NO background correction is increased, the NO concentration is decreased. Note that at this point, pressing  and  however, has no effect on the analog outputs or the stored NO background correction of 0.0 ppm. A question mark following both the NO reading and the NO background correction indicates that these are proposed changes as opposed to implemented changes. To escape this screen without saving any changes, press  to return to the Calibration Factors menu or  to return to the Run screen. Press  to actually set the NO reading to 0 ppm and store the new background correction of .44 ppm. Then the question mark prompt beside the NO reading disappears.

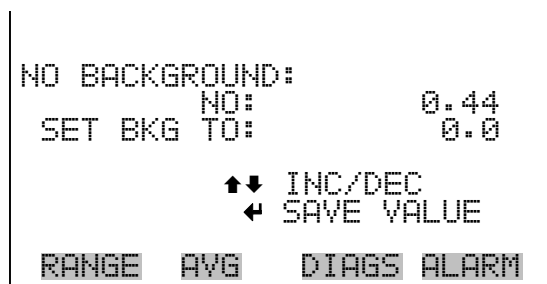

- In the Main Menu, choose Calibration Factors > **NO or NO_x Background**.
- Use  and  to increment or decrement the proposed background value.
- Press  to save the new background.



NO, NO₂, and NO_x Coefficients



The NO, NO₂, and NO_x span coefficients are usually calculated by the instrument processor during calibration. The span coefficients are used to correct the NO, NO₂, and NO_x readings. The NO and NO_x span coefficients normally have values near 1.000. The NO₂ span coefficient normally has a value between 0.95 and 1.050.

The NO, NO₂, and NO_x Coefficient screens allow the NO, NO₂, and NO_x span coefficients to be manually changed while sampling span gas of known concentration. The NO, NO₂, and NO_x coefficient screens operate the same way. Therefore, the following description of the NO coefficient screen applies to the NO₂ and NO_x coefficient screens as well.

The display shows the current NO concentration reading. The next line of the display shows the NO span coefficient that is stored in memory and is being used to correct the NO concentration. Notice that as the span coefficient value is changed, the current NO concentration reading on the above line also changes. However, no real changes are made to the value stored in memory until  is pressed. Only proposed changes, as indicated by a question mark prompt, are displayed until  is pressed.

In dual or auto range mode, “High” or “Low” is displayed to indicate the calibration of the high or low coefficient. The example below shows the coefficient screen in single mode.

Note The concentration value will show ERROR if the measured concentration is not a valid span value (either higher than the selected range, or 0 or lower). ▲

- In the Main Menu, choose Calibration Factors > NO, NO₂ or NO_x Coef.
- Use  and  to increment or decrement the coefficient value.

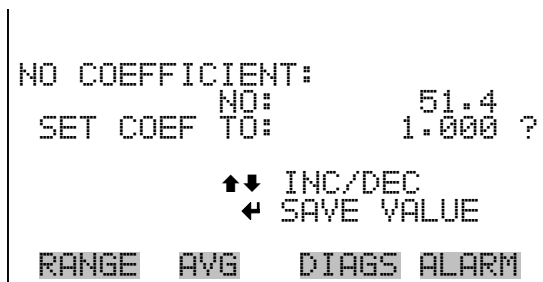

- Press  to save the new coefficient.



Calibration Pressure

The Calibration Pressure screen reports the reactor pressure at which current calibration was performed. The screen also allows this value to be edited by the operator. This value should not be changed unless a complete manual calibration is being performed. The calibration pressure is set equal to the reactor pressure at the time of calibration.



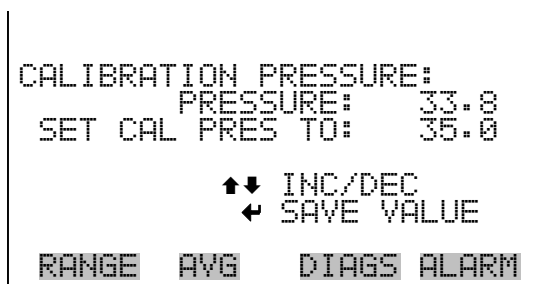

Note Turning the pressure compensation on and off can produce significant artificial jumps in the apparent sample concentration. If the pressure compensation feature is to be used, the instrument must be calibrated with the pressure compensation feature on. For more information about calibration, see Chapter 4, “Calibration”. ▲

- In the Main Menu, choose Calibration Factors > **Calibration Pressure**.
- Use  and  to increment or decrement the calibration pressure value.
- Press  to save the new calibration pressure.



Reset User Calibration Default

The Reset User Calibration Default screen allows the user to reset the calibration configuration values to factory defaults.

- In the Main Menu, choose Service > Calibration Factors > **Reset User Cal Defaults**.
- Press  to warn user and enable restore with .
- Use  to reset the calibration pressure reference value when pressed after .

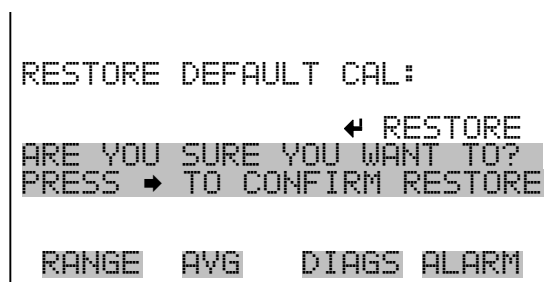
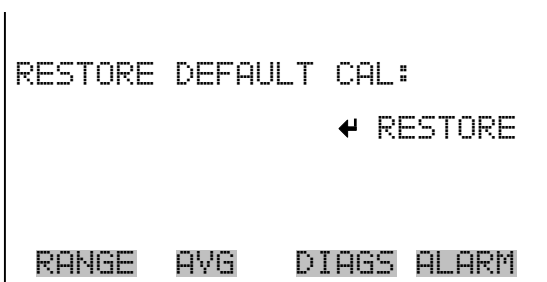

Calibration Menu

The Calibration menu is used to calibrate the analyzer, including zero backgrounds, the NO, NO₂, and NO_x coefficients, and the calibration pressure. The screens below show the calibration menu in single mode and dual/auto range modes.

The calibration procedure is the same in dual, auto, or single range, however, there are two sets of gas coefficients in dual or auto range (i.e. low and high coefficients). This enables each range to be calibrated separately. When calibrating the instrument in dual or auto range, be sure to use a low span gas to calibrate the low range and a high span gas to calibrate the high range.

Whether dual or single range, the first step in calibrating the instrument is to assign the calibration pressure. The calibration pressure is used to account for slight pressure fluctuation brought on by changing weather. The calibration pressure is set equal to the reactor pressure at the time of calibration. For more information about calibration, see Chapter 4, “Calibration”.

- In the Main Menu, choose **Calibration**.

```

CALIBRATION:
>CAL NO BACKGROUND
CAL NOx BACKGROUND
CAL NO COEFFICIENT
CAL NO2 COEFFICIENT
CAL NOx COEFFICIENT
CALIBRATE PRESSURE
ZERO/SPAN CHECK

RANGE  AVG  DIAGS  ALARM
  
```

```

CALIBRATION:
>CAL NO BACKGROUND
CAL NOx BACKGROUND
CAL HI NO COEFFICIENT
CAL HI NO2 COEFFICIENT
CAL HI NOx COEFFICIENT
CAL LO NO COEFFICIENT
CAL LO NO2 COEFFICIENT  ↓

RANGE  AVG  DIAGS  ALARM
  
```

```

CAL LO NOx COEFFICIENT
CALIBRATE PRESSURE
  
```

Calibrate NO and NO_x Background

The Calibrate NO and NO_x Background screens are used to adjust the background, or perform a “zero calibration”. Be sure the analyzer samples zero air until the readings stabilize. The display shows the current NO or NO_x reading.

It is important to note the averaging time when calibrating. The longer the averaging time, the more precise the calibration will be. For the most precise calibration, use the 300-second averaging time. For more information about calibration, see Chapter 4, “Calibration”.

- In the Main Menu, choose Calibration > **Calibrate NO** or **NO_x Background**.
- Press  to set the new reading to zero.

```

NO BACKGROUND:
NO: 1.2
CURRENTLY: 0.0 ?

← SET NO TO ZERO





RANGE  AVG  DIAGS  ALARM
  
```

Calibrate NO, NO₂, and NO_x Coefficients

The Calibrate NO Coefficient screen is used to adjust the NO span concentrations while sampling span gas of known concentration. All calibration screens operate the same way. Therefore, the following description of the NO calibration screen applies to the NO₂ and NO_x calibration screens as well.

The display shows the current NO concentration reading and the current NO range. The next line of the display is where the NO calibration gas concentration is entered.

It is important to note the averaging time when calibrating. The longer the averaging time, the more precise the calibration will be. For the most precise calibration, use the 300-second averaging time. For more information about calibration, see Chapter 4, "Calibration".

- In the Main Menu, choose Calibration > **Cal NO, NO₂, or NO_x Coefficients**.
- Use  and  pushbuttons to move the cursor left or right.
- Use  and  to increment or decrement the numeric value.
- Press  to calculate and save the new coefficient based on the entered span concentration.

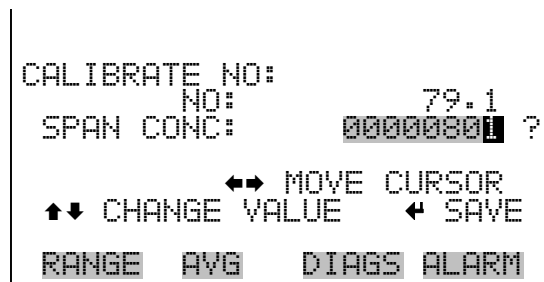

Calibrate Pressure

The Calibrate Pressure screen is used to set the calibration pressure.

The calibration pressure should be set only when calibrating the instrument.

- In the Main Menu, choose Calibration > **Calibrate Pressure**.
- Press  to save the current chamber as the new calibration pressure.

```

CALIBRATE PRESSURE:
CUR CAL PRES: 35.0 mmHg
CURRENT PRES: 33.8 mmHg ?

← SAVE CURRENT PRESSURE
AS CAL PRESSURE

RANGE  AVG  DIAGS  ALARM
  
```

Zero/Span Check

The Zero/Span Check menu is available with the zero/span valve option. It is used to program the instrument to perform fully automated zero and span check or adjustments. Total Duration Hour is the sum of zero, span, and purge duration minutes. Zero and Span Calibration Reset are toggle items that change between yes or no when selected, and displayed if auto calibration is installed.

- In the Main Menu, choose Calibration > **Zero/Span Check**.

```





ZERO/SPAN CHECK:
>NEXT TIME 01Jan05 12:00
PERIOD HR 24
TOTAL DURATION HR 1.5
ZERO DURATION MIN 30
SPAN DURATION MIN 30
PURGE DURATION MIN 30
ZERO/SPAN AVG SEC 60 ↓

RANGE  AVG  DIAGS  ALARM
  
```

```



ZERO CAL RESET
SPAN CAL RESET OFF
ZERO/SPAN RATIO 1
  
```

Next Time The Next Time screen is used to view and set the next zero/span check date and time. Once the initial zero/span check is performed, the date and time of the next zero/span check is calculated and displayed.

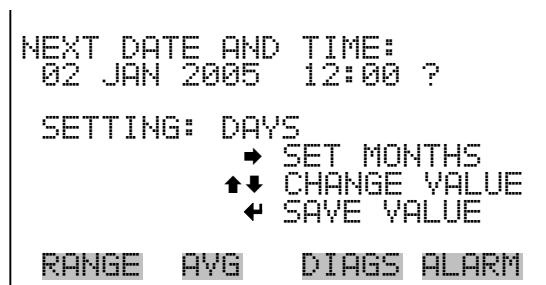
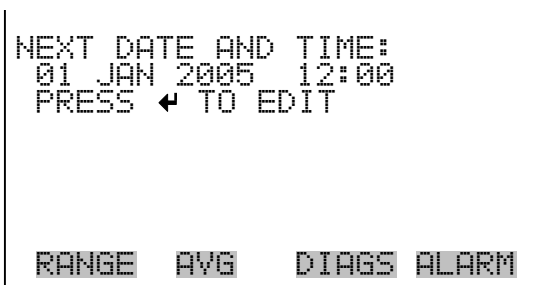
- In the Main Menu, choose Calibration > Zero/Span Check > **Next Time**.
- Use , ,  and  to move and change the value of the date and time.
- Press  to accept a change.



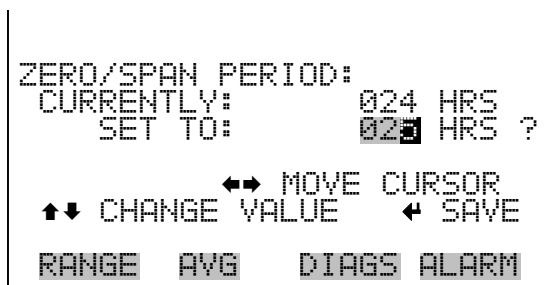

Period Hours The Zero/Span Period Hours screen defines the period or interval between zero/span checks. Periods between 0 and 999 hours are acceptable. To turn the zero/span check off, set the period to 0.

- In the Main Menu, choose Calibration > Zero/Span Check > **Period Hours**.
- Use  and  to increment and decrement the numeric value.
- Press  to save the period.



Zero/Span/Purge Duration Minutes

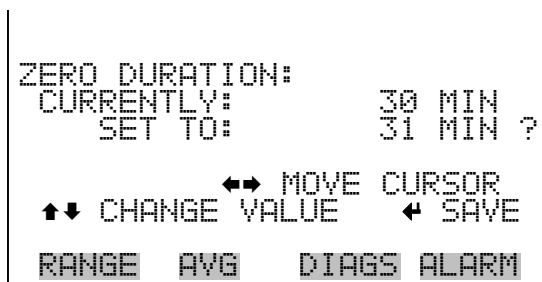

The Zero Duration Minutes screen defines how long zero air is sampled by the instrument. The span and purge duration screens look and function the same way as the zero duration screen, and are used to set how long the span gas and sample gas are sampled by the instrument. Durations between 0 and 60 minutes are acceptable. Each time a zero/span check occurs the zero check is done first, followed by the span check. To perform just a zero check, set the span and purge duration screen to 0 (off). The same applies to perform just a span or purge check.

- In the Main Menu, choose Calibration > Zero/Span Check > **Zero, Span or Purge Duration Min.**
- Use  and  to increment and decrement the numeric value.
- Press  to save the duration value.



Zero/Span Averaging Time

The Zero/Span Averaging Time screen allows the user to adjust the zero/span averaging time. The zero/span averaging time is used by the analyzer only when performing an automatic zero or span check. The analyzer's averaging time is used for all other functions. The following averaging times are available: 1, 2, 5, 10, 20, 30, 60, 90, 120, 180, 240, and 300 seconds.

- In the Main Menu, choose Calibration > Zero/Span Check > **Zero/Span Avg Sec.**
- Use  and  to scroll through a list of choices.
- Press  to save the averaging time.

```
ZERO/SPAN AVERAGING TIME:
CURRENTLY:          60 SEC
SET TO:            90 SEC ?

      ↑↓ CHANGE VALUE
      ← SAVE VALUE

RANGE  AVG  DIAGS  ALARM
```

Zero/Span Ratio

The Zero/Span Ratio screen is used to adjust the ratio of zeros to spans. For example, if this value is set to 1, a span check will follow every zero check. If this value is set to 3, there will be two zero checks between each zero/span check. This value may be set from 1 to 10, with 1 as default.

- In the Main Menu, choose Calibration > Zero/Span Check > **Zero/Span Ratio**.
- Use and to increment and decrement the numeric value.
- Press to save the ratio value.

```
ZERO/SPAN RATIO:
CURRENTLY:          1 :1
SET TO:            2 :1 ?

      ↑↓ CHANGE VALUE
      ← SAVE VALUE

RANGE  AVG  DIAGS  ALARM
```

Instrument Controls Menu

The Instrument Controls menu contains a number of items. The software controls listed in this menu enable control of the listed instrument functions.

- In the Main Menu, choose **Instrument Controls**.

```

INSTRUMENT CONTROLS:
>OZONATOR
  PMT SUPPLY
  AUTO/MANUAL MODE
  DATALOGGING SETTINGS
  COMMUNICATION SETTINGS
  I/O CONFIGURATION
  TEMPERATURE COMPENSATION↓
  RANGE  AVG  DIAGS  ALARM
  
```

```

PRESSURE COMPENSATION
SCREEN CONTRAST
SERVICE MODE
DATE/TIME
  
```

Ozonator

The Ozonator screen is used to turn the internal ozonator on or off. The display shows the status of the control line that turns the ozonator on or off. The next line of the display shows the user-specified ozonator setting. Under most conditions, the control line status and ozonator set status are the same. However, as a safety precaution, the microprocessor can override the user-specified ozonator setting. This occurs only if the ozonator flow doesn't indicate any flow or if the NO₂ converter temperature is below the minimum alarm limit. In this case, an alarm is activated and the ozonator is turned off. This is done to prevent the ozonator from overheating, which will result in permanent damage to the ozonator, or if the converter temperature drops below the minimum limit, which reduces the effectiveness of the ozone destruct.

It is possible, however, to defeat this feature, by setting the ozonator safety "OFF" in the "Service Menu".

Note The ozonator must be "ON" to obtain NO, NO₂, and NO_x readings. As an additional safety precaution, a lit LED mounted on the measurement interface board indicates that the ozonator is on. ▲

- In the Main Menu, choose Instrument Controls > **Ozonator**.
- Press  to toggle and set the ozonator on or off.



PMT Supply

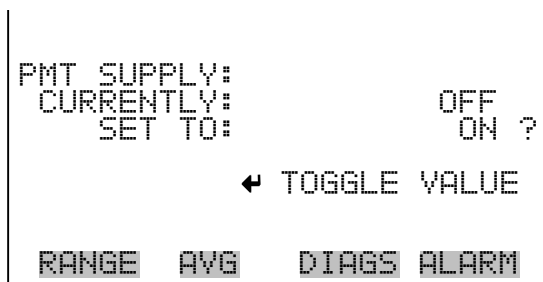

The PMT Supply screen is used to turn the PMT power supply on or off. This is useful in a troubleshooting situation.

- In the Main Menu, choose Instrument Controls > **PMT Supply**.
- Press  to toggle and set the PMT supply on or off.



Auto/Manual Mode

The Auto/Manual Mode screen allows selection of the automatic mode (NO/NO_x), NO mode (manual NO), or NO_x mode (manual NO_x). The auto mode switches the mode solenoid valve automatically on a 10 second cycle so that NO, NO₂, and NO_x concentrations are determined. The manual NO mode puts the mode solenoid valve into the open position so that the sample gas bypasses the NO₂-to-NO converter. Therefore, only the NO concentration is determined. The manual NO_x mode puts the mode solenoid valve into the closed position so that the sample gas passes through the NO₂-to-NO converter. Therefore, only the NO_x concentration is determined. In the manual modes, additional averaging times of 1, 2, and 5 seconds are available from the Averaging Time screen.

- In the Main Menu, choose Instrument Controls > **Auto/Manual Mode**.
- Use  and  to scroll through a list of choices.

- Press  to save the new mode state.

```

MODE:
CURRENTLY:      MANUAL NO
SET TO:         NO/NOX ?

      ↑↓ CHANGE VALUE
      ← SAVE VALUE

RANGE  AVG  DIAGS  ALARM
  
```

Datalogging Settings

The Datalogging Settings menu deals with datalogging.

- In the Main Menu, choose Instrument Controls > **Datalogging Settings**.



```

DATALOGGING SETTINGS:
>SELECT SREC/LREC      SREC
VIEW LOGGED DATA
ERASE LOG
SELECT CONTENT
COMMIT CONTENT
RESET TO DEFAULT CONTENT
CONFIGURE DATA LOGGING

RANGE  AVG  DIAGS  ALARM
  
```

Select SREC/LREC

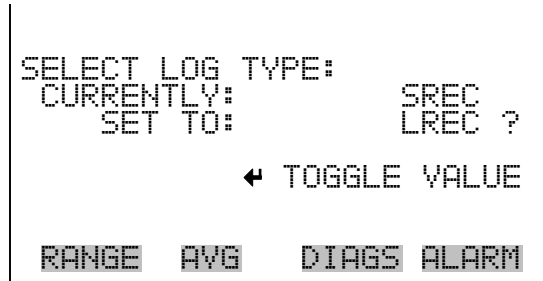

The Select SREC/LREC is used to select short record or long record format for other operations in this menu.

- In the Main Menu, choose Instrument Controls > Datalogging Settings > **Select SREC/LREC**.
- Use  and  to scroll through a list of choices.
- Press  to set record format.



View Logged Data

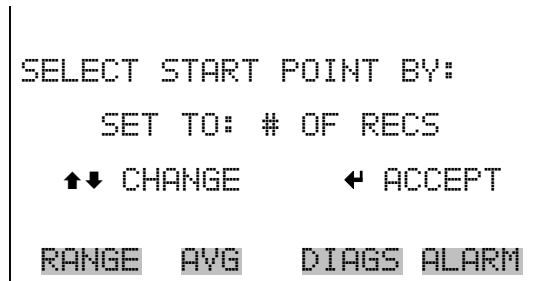

The View Logged Data screen is used to select the start point to view the logged data by number of records or date and time.

- In the Main Menu, choose Instrument Controls > Datalogging Settings > Select SREC or LREC > **View Logged Data**.
- Use  and  to toggle between number of records or date and time.
- Press  to accept.



Number of Records

The Number of Records screen is used to select the starting point to display the number of records back to view.

- Use  and  to increment or decrement the numeric value.
- Press  to set the starting record and continue to the record display screen.

```

SET # BACK FROM CURRENT:
                                00000000
TOTAL LRECS:                    20

      ↔ MOVE CURSOR
↕ CHANGE VALUE      ← SAVE

RANGE  AVG  DIAGS  ALARM
  
```

The Record Display screen (read only) displays the selected records.

- Use and to view all the items in the record.
- Use and to view records at different times.

```

time      date      flags
10:00    06/20/05   FC0088900
11:00    06/20/05   FC0088900
12:00    06/20/05   FC0088900
13:00    06/20/05   FC0088900
↕ PGUP/DN  ↔ PAN L/R

RANGE  AVG  DIAGS  ALARM
  
```

Date and Time

The Date and Time screen is used to set a start date and time for which to view logged data. For example, if “20 JUN 2005 10:00” is entered, then the first logged data record that is displayed is the first record after this time. If set to one minute logging, this would be at “20 JUN 2005 10:01”.

- Use and to increment or decrement the selected field.
- Use to advance to next field.
- Press to set the date and time of the first record to be displayed and continue to the record display screen.

Operation

Instrument Controls Menu

```
DATE AND TIME:
20 JUN 2005 10:00
↑↓ CHG DAYS
→ SET CURSOR TO MONTHS
← ACCEPT AS SHOWN

RANGE  AVG  DIAGS  ALARM
```

The Record Display screen (read only) displays the selected records.

- Use and to view all the items in the record.
- Use and to view records at different times.

```
time    date    flags
10:01  06/20/05  FC0088900
10:02  06/20/05  FC0088900
10:03  06/20/05  FC0088900
10:04  06/20/05  FC0088900
↑↓ PGUP/DN  ↔ PAN L/R

RANGE  AVG  DIAGS  ALARM
```

Erase Log The Erase Log is used to erase all saved data for the selected record type (not all short records and long records).

- In the Main Menu, choose Instrument Controls > Datalogging Settings > Erase Log.
- Press to erase all data.
- Press to confirm erasure.



Select Content



The Select Content submenu displays a list of 32 record fields to use and a submenu list of the analog output signal group choices to choose from. Choices are Concentrations, Other Measurements, and Analog Inputs (if the I/O expansion board is installed). This is a temporary list of items for the selected record type that must be committed via the datalogging menu before the changes will apply. Note that committing any changes to this list will erase all currently logged data, as the format of the stored data is changed.

- In the Main Menu, choose Instrument Controls > Datalogging Settings > Select Content.



Concentrations

The Concentrations screen allows the user to select the output signal that is tied to the selected field item. The selected item is shown by “<--” after it. Note that at this point, pressing  indicates that these are proposed changes as opposed to implemented changes. To change the selected record format and erase record log file data, see “Commit Content” below. Range (NO_x) is visible only in auto range mode.



- In the Main Menu, choose Instrument Controls > Datalogging Settings > Select Content > Select Field > **Concentrations**.
- Use  and  to move the cursor up and down.
- Press  to select a new choice.

```
CONCENTRATIONS:
>NONE
NO
NO2
NOx
LO NO
LO NO2
LO NOx
                                     <--
                                     ↓
RANGE  AVG  DIAGS  ALARM
```

```
HI NO
HI NO2
HI NOx
RANGE (NOx)
```

Other Measurements

The Other Measurements screen allows the user to select the output signal that is tied to the selected field item. The selected item is shown by “<--” after it. Note that at this point, pressing  indicates that these are proposed changes as opposed to implemented changes. To change the selected record format and erase record log file data, see “Commit Content” below.

- In the Main Menu, choose Instrument Controls > Datalogging Settings > Select Content > Select Field > **Other Measurements**.
- Use  and  to move the cursor up and down.
- Press  to select a new choice.



```



OTHER MEASUREMENTS:
>NONE
INT TEMP
CHAMBER TEMP
COOLER TEMP
NO2 CONV TEMP
CHAMBER PRES
FLOW
↓
RANGE  AVG  DIAGS  ALARM
  
```

```

PMT VOLTS
OZONATOR FLOW
  
```

Analog Inputs

The Analog Inputs screen allows the user to select the output signal (none or analog input 1-8) that is tied to the selected field item. The selected item is shown by “<--” after it. Note that at this point, pressing  indicates that these are proposed changes as opposed to implemented changes. To change the selected record format and erase record log file data, see “Commit Content” below.

- In the Main Menu, choose Instrument Controls > Datalogging Settings > Select Content > Select Field > **Analog Inputs**.
- Use  and  to move the cursor up and down.
- Press  to select a new choice.

```

ANALOG INPUTS:
>NONE
ANALOG IN 1
ANALOG IN 2
ANALOG IN 3
ANALOG IN 4
ANALOG IN 5
ANALOG IN 6
↓
RANGE  AVG  DIAGS  ALARM
  
```



Commit Content

The Commit Content screen is used to save the selected output signal that is tied to the selected field item. For more information about selecting the analog output signal group choices, see “Select Content” above.

- In the Main Menu, choose Instrument Controls > Datalogging Settings > **Commit Content**.

Operation

Instrument Controls Menu

- Press  to commit changes to selected record format and erase record log file data.
- Press  to confirm changes.

```
CHANGE LREC FORMAT AND
ERASE LREC LOG FILE DATA?
      ← COMMIT



RANGE  AVG  DIAGS  ALARM
```

```
CHANGE LREC FORMAT AND
ERASE LREC LOG FILE DATA?
      ← COMMIT
ARE YOU SURE YOU WANT TO?
PRESS → TO CONFIRM CHANGES

RANGE  AVG  DIAGS  ALARM
```

Reset to Default Content

The Reset to Default Content screen is used to reset all of the datalogging field items to default values. For more information about selecting the analog output signal group choices, see “Select Content” above.

- In the Main Menu, choose Instrument Controls > Datalogging Settings > **Reset to Default Content**.
- Press  to reset selected record format and erase record log file data.
- Press  to reset.

```
RESET LREC FORMAT AND
ERASE LREC LOG FILE DATA?
      ← RESET

RANGE  AVG  DIAGS  ALARM
```

```
RESET LREC FORMAT AND
ERASE LREC LOG FILE DATA?
      ← RESET
ARE YOU SURE YOU WANT TO?
PRESS → TO CONFIRM RESET

RANGE  AVG  DIAGS  ALARM
```

Configure Datalogging

The Configure Datalogging menu deals with datalogging configuration for the currently selected record type.

- In the Main Menu, choose Instrument Controls > Datalogging Settings > **Configure Datalogging**.

```

DATALOGGING SETTINGS:
>LOGGING PERIOD MIN  OFF
MEMORY ALLOCATION %   50
DATA TREATMENT       AVG

RANGE  AVG  DIAGS  ALARM
  
```

Logging Period Min

The Logging Period Min screen is used to select the logging period in minutes for the record format (srec or lrec). List of choices include: off, 1, 5, 15, 30, and 60 minutes (default).

- In the Main Menu, choose Instrument Controls > Datalogging Settings > Configure Datalogging > **Logging Period Min**.
- Use and to scroll through a list of choices.
- Press to set the logging period.

```

SET PERIOD FOR SREC:
CURRENTLY:           OFF MIN
SET TO:              60 MIN ?

↑↓ CHANGE VALUE    ← SAVE

RANGE  AVG  DIAGS  ALARM
  
```

Memory Allocation Percent

The Memory Allocation Percent screen is used to select the percentage of each record type for both short records and long records. Percentages between 0 and 100% are available in increments of 10. Changing this value results in log erasure for both short records and long records.

- In the Main Menu, choose Instrument Controls > Datalogging Settings > Configure Datalogging > **Memory Allocation %**.
- Use and to scroll through a list of choices.
- Press to set the percentage for both record types and proceed to the erasure warning screen.

Operation

Instrument Controls Menu

- Press  to confirm change.

```
SET PERCENT SRECS:
CURRENTLY:      50 %
SET TO:        60 % ?

↓ CHANGE VALUE  ← SAVE



RANGE  AVG  DIAGS  ALARM
```

```
SET PERCENT SRECS:
CURRENTLY:      50 %
SET TO:        60 % ?
THIS WILL ERASE ALL LOGS!
PRESS → TO CONFIRM CHANGE

RANGE  AVG  DIAGS  ALARM
```

Data Treatment

The Data Treatment screen is used to select the data type for the selected record: whether the data should be averaged over the interval, the minimum or maximum used, or the current value logged. Data treatment doesn't apply to all data, just to the concentration measurement. All other data points log the current value at the end of the interval.

- In the Main Menu, choose Instrument Controls > Datalogging Settings > Configure Datalogging > **Data Treatment**.
- Use  and  to scroll through a list of choices.
- Press  to set the data type.

```
SET LREC DATA TYPE:
CURRENTLY:  AVG
SET TO:    CUR      ?

↑↓ CHANGE VALUE  ← SAVE

RANGE  AVG  DIAGS  ALARM
```

Communication Settings

The communication Settings menu is used with communications control and configuration.

- In the Main Menu, choose Instrument Controls > **Communication Settings**.



```

COMMUNICATION SETTINGS:
>BAUD RATE
  INSTRUMENT ID
  COMMUNICATION PROTOCOL
  STREAMING DATA CONFIG
  RS-232/RS-485 SELECTION
  TCP/IP SETTINGS

RANGE  AVG  DIAGS  ALARM
  
```

Baud Rate

The Baud Rate screen is used to set the RS-232/RS-485 interface baud rate. Baud rates of 1200, 2400, 4800, and 9600, 19200, 38400, 57600, and 115200 are available.

- In the Main Menu, choose Instrument Controls > Communication Settings > **Baud Rate**.
- Use  and  to scroll through a list of choices.
- Press  to save the new baud rate.

```

BAUD RATE:
CURRENTLY:          9600
SET TO:            19200  ?

  ↑↓ CHANGE VALUE
  ← SAVE VALUE

RANGE  AVG  DIAGS  ALARM
  
```



Instrument ID

The Instrument ID screen allows the operator to edit the instrument ID. The ID is used to identify the instrument when using the C-Link or MODBUS protocols to control the instrument or collect data. It may be necessary to edit the ID number if two or more of the same instrument are connected to one computer over the serial port. Valid Instrument ID numbers are from 0 to 127. The Model 42i High Level has a default

Operation

Instrument Controls Menu

Instrument ID of 42. For more information about the Instrument ID, see Appendix B “C-Link Protocol Commands” or Appendix C “MODBUS Protocol”.

- In the Main Menu, choose Instrument Controls > Communication Settings > **Instrument ID**.
- Use  and  to increment or decrement the ID value.
- Press  to save the new instrument ID.

```
INSTRUMENT ID:
CURRENTLY:      42
SET TO:         50 ?



  ↑↓ CHANGE VALUE
  ← SAVE VALUE

RANGE  AVG  DIAGS  ALARM
```

Communication Protocol

The Communication Protocol screen is used to change the instrument communication protocol for serial communications. This does not affect communications over Ethernet, because the protocols are processed simultaneously on different ports.

In the Main Menu, choose Instrument Controls > Communication Settings > **Communication Protocol**.

- Use  and  to scroll through a list of choices.
- Press  to save the new protocol.

```
COMMUNICATION PROTOCOL:
CURRENTLY:      CLINK
SET TO:         STREAMING ?

  ↑↓ CHANGE VALUE
  ← SAVE VALUE

RANGE  AVG  DIAGS  ALARM
```

Streaming Data Configuration

The Streaming Data Configuration menu is used to allow for configuration of the 18 streaming data output items, streaming interval, current data format, and current time. The Choose Stream Data submenu displays a list of the analog signal group choices to choose from. Choices are Concentrations, Other Measurements, and Analog Inputs (if the I/O expansion board option is installed).

Note Add Labels and Prepend Timestamp are toggle items that change between yes or no when selected. ▲

- In the Main Menu, choose Instrument Controls > Communication Settings > **Streaming Data Config.**

```



STREAMING DATA CONFIG:
INTERVAL          10 SEC
ADD LABELS        NO
PREPEND TIMESTAMP YES
>ITEM 1           NO2
ITEM 2            INTT
ITEM 3            PRES
ITEM 4            NONE
RANGE  AVG  DIAGS ALARM
    
```

```

CHOOSE STREAM DATA:
>CONCENTRATIONS
OTHER MEASUREMENTS
ANALOG INPUTS
RANGE  AVG  DIAGS ALARM
    
```

Streaming Data Interval

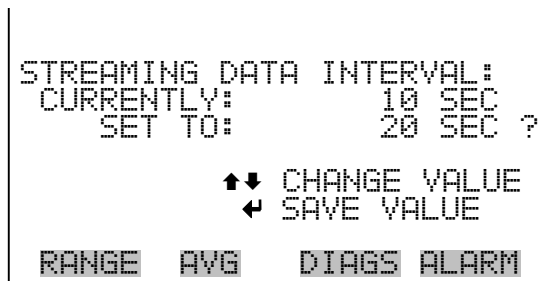

The Streaming Data Interval screen is used to adjust the streaming data interval. The following interval times are available: 1, 2, 5, 10, 20, 30, 60, 90, 120, 180, 240, and 300 seconds.

- In the Main Menu, choose Instrument Controls > Communication Settings > Streaming Data Config > **Interval.**
- Use  and  to scroll through a list of choices.
- Press  to save the new streaming data period.



Concentrations

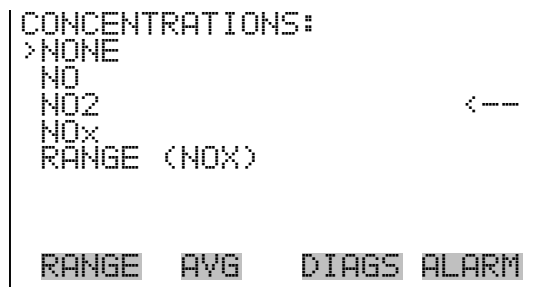

The Concentrations screen allows the user to select the output signal that is tied to the selected streaming data item. The selected item is shown by “<--” after it. In dual or auto range mode, “High” or “Low” is displayed to indicate high or low concentrations. Range (NO_x) is visible only in auto range mode.

- In the Main Menu, choose Instrument Controls > Communication Settings > Streaming Data Config > Select Item > **Concentrations**.
- Use  and  to move the cursor up and down.
- Press  to select a new choice.



Other Measurements

The Other Measurements screen allows the user to select the output signal that is tied to the selected streaming data item. The selected item is shown by “<--” after it.

- In the Main Menu, choose Instrument Controls > Communication Settings > Streaming Data Config > Select Item > **Other Measurements**.
- Use  and  to move the cursor up and down.



- Press  to select a new choice.

```
OTHER MEASUREMENTS:
>NONE
INT TEMP
CHAMBER TEMP
COOLER TEMP
NO2 CNV TEMP
CHAMBER PRES
FLOW
↓
RANGE  AVG  DIAGS  ALARM
```

PMT VOLTS

Analog Inputs

The Analog Inputs screen allows the user to select the output signal (none or analog inputs 1-8) that is tied to the selected streaming data item. The selected item is shown by “<--” after it.

- In the Main Menu, choose Instrument Controls > Communication Settings > Streaming Data Config > Select Item > **Analog Inputs**.
- Use  and  to move the cursor up and down.
- Press  to select a new choice.

```
ANALOG INPUTS:
>NONE
ANALOG IN 1
ANALOG IN 2
ANALOG IN 3
ANALOG IN 4
ANALOG IN 5
ANALOG IN 6
↓
RANGE  AVG  DIAGS  ALARM
```

RS-232/RS-485 Selection



The RS-232/RS-485 Selection screen allows the user to choose between the RS-232 or RS-485 specification for serial communication.

Note Disconnect the serial cable before changing RS-232 and RS-485 selection to prevent damage to the connected equipment. ▲

- In the Main Menu, choose Instrument Controls > Communication Settings > **RS-232/RS-485 Selection**.

Operation

Instrument Controls Menu

- Press  to leave the warning screen and move to next screen.
- Use  to confirm and save the new selection change.

```
RS-232/RS-485 SELECTION:
** WARNING **
DISCONNECT THE SERIAL
CABLES BEFORE CHANGING
THE SELECTION!
      ← TO CONTINUE

RANGE  AVG  DIAGS  ALARM
```

```
RS-232/RS-485 SELECTION:
CURRENTLY:      RS-232
SET TO:        RS-485 ?
MAKE SURE THAT THE CABLE
IS OFF: PRESS → TO CONFIRM
      ← TOGGLE VALUE

RANGE  AVG  DIAGS  ALARM
```

TCP/IP Settings The TCP/IP Settings menu is used for defining TCP/IP settings.

- In the Main Menu, choose Instrument Controls > Communication Settings > TCP/IP Settings.

```
TCP/IP SETTINGS:
>USE DHCP      OFF
IP ADDRESS    192.168.1.15
NETMASK       255.255.255.0
GATEWAY       192.168.1.1
HOST NAME     ISERIES

RANGE  AVG  DIAGS  ALARM
```



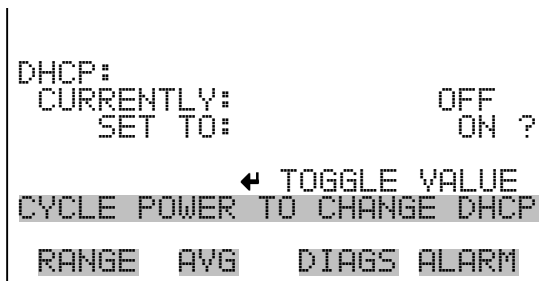

Use DHCP The Use DHCP screen is used to specify whether to use DHCP or not.

Note The instrument power must be cycled after this parameter has been changed for the change to take effect. ▲

- In the Main Menu, choose Instrument Controls > Communication Settings > TCP/IP Settings > Use DCHP.
- Press  to toggle and set DHCP on or off.





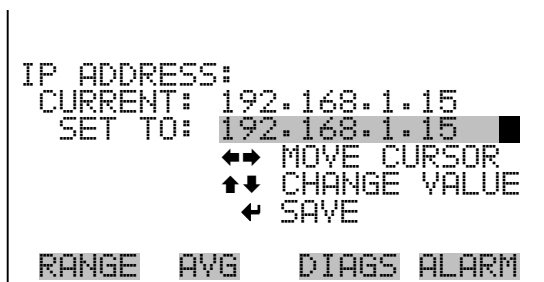

IP Address The IP Address screen is used to edit the IP address.

- In the Main Menu, choose Instrument Controls > Communication Settings > TCP/IP Settings > **IP Address**.
- Use , ,  and  to move and change the value of the IP address.
- Press  to save the new address.



Netmask The Netmask screen is used to edit the netmask address.

- In the Main Menu, choose Instrument Controls > Communication Settings > TCP/IP Settings > **Netmask**.
- Use , ,  and  to move and change the value of the netmask.
- Press  to save the new address.

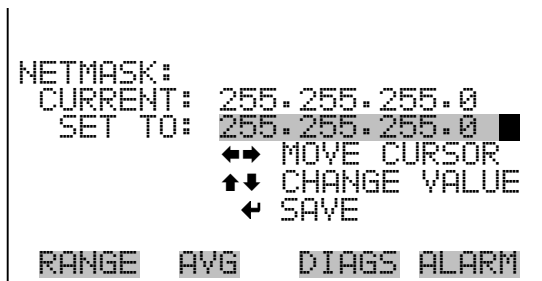

Gateway The Gateway screen is used to edit the gateway address.

- In the Main Menu, choose Instrument Controls > Communication Settings > TCP/IP Settings > **Gateway**.
- Use , , , and to move and change the value of the gateway address.
- Press to save the new address.

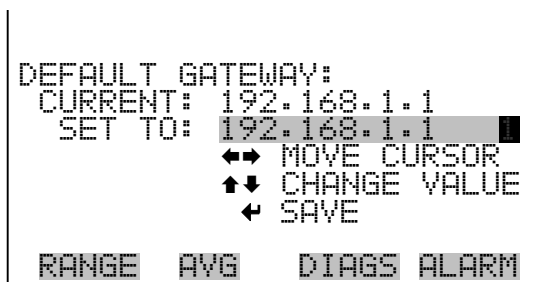

Host Name The host name screen is used to edit the host name. When DHCP is enabled, this name is reported to the DHCP server.

- In the Main Menu, choose Instrument Controls > Communication Settings > TCP/IP Settings > **Host Name**.
- Use , , , and to move the cursor or change between the edit field and the alpha page.
- Press to save the new letter in the alpha table or save the new alpha page.

```

HOST NAME:
CURRENT:  I SERIES
          I SERIES ?
          BCDEFGHIJKLMN BKSP
          OPQRSTUVWXYZ  PAGE
          0123456789 . / - SAVE

RANGE  AVG  DIAGS  ALARM

```

I/O Configuration

The I/O Configuration menu deals with configuration of the analyzer's I/O system. The analog input configuration is displayed if the I/O expansion board option is installed.

- In the Main Menu, choose Instrument Controls > **I/O Configuration**.

```

I/O CONFIGURATION:
> OUTPUT RELAY SETTINGS
  DIGITAL INPUT SETTINGS
  ANALOG OUTPUT CONFIG
  ANALOG INPUT CONFIG

RANGE  AVG  DIAGS  ALARM

```

Output Relay Settings

The Output Relay Settings menu displays a list of the 10 analog output relays available, and allows the user to select the logic state or instrument parameter for the relay selected.

Note The digital outputs may take up to one second after the assigned state occurs to show up on the outputs. ▲

- In the Main Menu, choose Instrument Controls > I/O Configuration > **Output Relay Settings**.

Operation

Instrument Controls Menu

```
OUTPUT RELAY SETTINGS:
>1    NOP          GEN ALARM
2     NOP          NONE
3     NOP          UNITS
4     NOP          CONC ALARM
5     NOP          NONE
6     NOP          NONE
7     NOP          NO MODE ↓
RANGE  AVG  DIAGS  ALARM
```

Logic State

The Logic State screen is used to change the I/O relay to either normally open or normally closed.

- Press  to toggle and set the logic state between open or closed.

```
OUTPUT RELAY SETUP:
>LOGIC STATE      OPEN
INSTRUMENT STATE
RANGE  AVG  DIAGS  ALARM
```



Instrument State

The Instrument State submenu allows the user to select the instrument state that is tied to the selected relay output. A submenu lists signal types of either alarms or non-alarm to choose from.

- In the Main Menu, choose Instrument Controls > I/O Configuration > Output Relay Settings > Select Relay > **Instrument State**.

```
CHOOSE SIGNAL TYPE:
>ALARMS
NON-ALARM
RANGE  AVG  DIAGS  ALARM
```



Alarms The Alarms status screen allows the user to select the alarm status for the selected relay output. The selected item is shown by “<--” after it. Items displayed are determined by the options installed.

- In the Main Menu, choose Instrument Controls > I/O Configuration > Output Relay Settings > Select Relay > Instrument State > **Alarms**.
- Use  and  to scroll through a list of choices.
- Press  to save the new selection for the relay.

```
ALARM STATUS ITEMS:
>NONE
GEN ALARM <--
NO CONC MAX
NO CONC MIN
NO2 CONC MAX
NO2 CONC MIN
NOx CONC MAX
↓
RANGE  AVG  DIAGS  ALARM
```

```
NOx CONC MIN
INT TEMP
CHAMB TEMP
COOLER TEMP
NO2 CV TEMP
PRESSURE
FLOW
OZONE FLOW
MB STATUS
MIB STATUS
I/O BD STATUS
CONC ALARM
```

Non-Alarm The Non-Alarm status screen allows the user to select the non-alarm status for the selected relay output. The selected item is shown by “<--” after it. Items displayed are determined by the options installed.

- In the Main Menu, choose Instrument Controls > I/O Configuration > Output Relay Settings > Select Relay > Instrument State > **Non-Alarm**.
- Use  and  to scroll through a list of choices.
- Press  to save the new selection for the relay.

```

NON ALARM STATUS ITEMS:
>NONE
AUTORANGE (NOX)
SERVICE
UNITS
ZERO MODE
SPAN MODE
NO MODE
↓
RANGE  AVG  DIAGS  ALARM
    
```

```

NOX MODE
SAMPLE MODE
PURGE MODE
    
```

Digital Input Settings

The Digital Input Settings menu displays a list of the 16 digital inputs available, and allows the user to select the logic state and instrument parameter for the relay selected.

Note The digital inputs must be asserted for at least one second for the action to be activated. ▲

- In the Main Menu, choose Instrument Controls > I/O Configuration > **Digital Input Settings**.

```

DIGITAL INPUT SETTINGS:
>1  NOP          NO MODE
2   NOP          NOX MODE
3   NOP          SET BACKGROUND
4   NOP          CAL TO LO SPAN
5   NOP          AOUTS TO ZERO
6   NOP          AOUTS TO FS
7   NOP          NONE
↓
RANGE  AVG  DIAGS  ALARM
    
```

Logic State

The Logic State screen is used to change the I/O relay to either normally open or normally closed. The default state is open, which indicates that a relay connected between the digital input pin and ground is normally open and closes to trigger the digital input action. If nothing is connected to the digital input pin, the state should be left at open to prevent the action from being triggered.



- Press  to toggle and set the logic state open or closed.

```
DIGITAL INPUT SETUP:
>LOGIC STATE      OPEN
INSTRUMENT ACTION

RANGE  AVG  DIAGS  ALARM
```

Instrument Action

The Instrument Action screen allows the user to select the instrument state that is tied to the selected digital input. The selected item is shown by “<--” after it.

- In the Main Menu, choose Instrument Controls > I/O Configuration > Digital Input Settings > Select Relay > **Instrument Action**.
- Use  and  to scroll through a list of choices.
- Press  to save the new selection for the relay.

```
CHOOSE ACTION:
>NONE
ZERO MODE
SPAN MODE
NO MODE      <--
NOX MODE
SET BACKGROUND
CAL TO LO SPAN

RANGE  AVG  DIAGS  ALARM
```

```
ROUTS TO ZERO
ROUTS TO FS
CAL TO HI SPAN
```

Analog Output Configuration

The Analog Output Configuration menu displays a list of the analog output channels available for configuration. Channel choices include all voltage channels, all current channels, voltage channels 1-6, and current channels 1-6 (if the I/O expansion board option is installed). Configuration choices include selecting range, setting minimum/maximum values, and choosing signal to output.

- In the Main Menu, choose Instrument Controls > I/O Configuration > **Analog Output Config**.

Operation



Instrument Controls Menu

```
OUTPUT CHANNELS:
>ALL VOLTAGE CHANNELS
ALL CURRENT CHANNELS
VOLTAGE CHANNEL 1
VOLTAGE CHANNEL 2
VOLTAGE CHANNEL 3
VOLTAGE CHANNEL 4
VOLTAGE CHANNEL 5
↓
RANGE  AVG  DIAGS  ALARM
```

```
ANALOG OUTPUT CONFIG:
>SELECT RANGE
SET MINIMUM VALUE
SET MAXIMUM VALUE
CHOOSE SIGNAL TO OUTPUT
RANGE  AVG  DIAGS  ALARM
```

Select Output Range



The Select Output Range screen is used to select the hardware range for the selected analog output channel. Possible ranges for the voltage outputs are: 0-100 mV, 0-1, 0-5, 0-10 V.

- In the Main Menu, choose Instrument Controls > I/O Configuration > Analog Output Config > Select Channel > **Select Range**.
- Use  and  to move the cursor up and down.
- Press  to save the new range.

```
SELECT OUTPUT RANGE:
SELECTED OUTPUT:  V ALL
CURRENTLY:        0-10V
SET TO:           0-5V  ?
↑↓ CHANGE VALUE  ← SAVE
RANGE  AVG  DIAGS  ALARM
```

Minimum and Maximum Value

The Minimum Value screen is used to edit the zero (0) to full-scale (100) value in percentages for the selected analog output channel. See [Table 3-6](#) for a list of choices. The minimum and maximum output value screens function the same way. The example below shows the set minimum value screen.

- In the Main Menu, choose Instrument Controls > IO Configuration > Analog Output Config > Select Channel > **Set Minimum** or **Maximum Value**.
- Use  and  to increment or decrement the numeric value.
- Press  to validate and save the new minimum value.

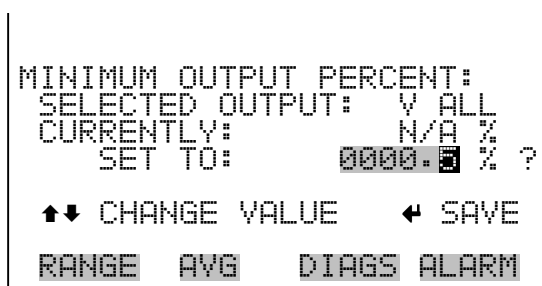

Table 3-6. Analog Output Zero to Full-Scale Table



Output	Zero % Value	Full-Scale 100% Value
NO	Zero (0)	Range Setting
NO ₂	Zero (0)	Range Setting
NO _x	Zero (0)	Range Setting
LO NO	Zero (0)	Range Setting
LO NO ₂	Zero (0)	Range Setting
LO NO _x	Zero (0)	Range Setting
HI NO	Zero (0)	Range Setting
HI NO ₂	Zero (0)	Range Setting
HI NO _x	Zero (0)	Range Setting
Range (NO _x)	Recommend not to change the setting for this output	
Internal Temp	User-set alarm min value	User-set alarm max value
Chamber Temp	User-set alarm min value	User-set alarm max value
Cooler Temp	User-set alarm min value	User-set alarm max value

Table 3-6. Analog Output Zero to Full-Scale Table, continued

Output	Zero % Value	Full-Scale 100% Value
NO ₂ Converter Temp	User-set alarm min value	User-set alarm max value
Chamber Pressure	User-set alarm min value	User-set alarm max value
Flow	User-set alarm min value	User-set alarm max value
PMT Volts	700 volts	1100 volts
Everything Else	0 units	10 units

Choose Signal to Output

The Choose Signal to Output screen displays a submenu list of the analog output signal group choices. Group choices are Concentrations, Other Measurements, and Analog Inputs (if the I/O expansion board option is installed). This allows the user to select the output signal to the selected output channel. The Concentrations screen is shown below. See [Table 3-7](#) below for a list of items for each signal group choice.

- In the Main Menu, choose Instrument Controls > I/O Configuration > Analog Output Config > Select Channel > **Choose Signal To Output**.
- Use  and  to move the cursor up and down.
- Press  to select a choice.

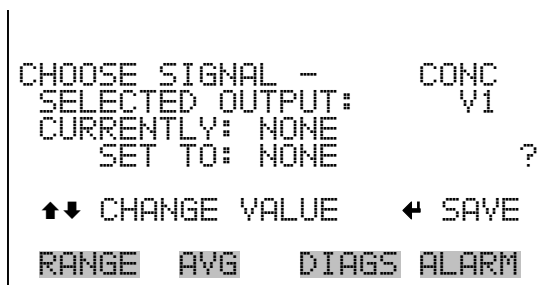

Table 3-7. Signal Type Group Choices

Concentrations	Other Measurements	Analog Inputs
None	None	None
NO (single/auto range mode)	Internal Temp	Analog Input 1
NO ₂ (single/auto range mode)	Chamber Temp	Analog Input 2
NO _x (single/auto range mode)	Cooler Temp	Analog Input 3

Table 3-7. Signal Type Group Choices, continued

Concentrations	Other Measurements	Analog Inputs
LO NO (dual mode)	NO ₂ Converter Temp	Analog Input 4
LO NO ₂ (dual mode)	Chamber Pressure	Analog Input 5
LO NO _x (dual mode)	Flow	Analog Input 6
HI NO (dual mode)	PMT Volts	Analog Input 7
HI NO ₂ (dual mode)		Analog Input 8
HI NO _x (dual mode)		
Range (NO _x) (auto range mode)		

Analog Input Configuration

The Analog Input Configuration menu displays a list of the 8 analog input channels available for configuration. This screen is displayed if the I/O expansion board option is installed. Configuration includes entering descriptor, units, decimal places, choice of 1-10 points in the table, and corresponding number of points selected.

- In the Main Menu, choose Instrument Controls > I/O Configuration > **Analog Input Config.**

```

ANALOG INPUT CONFIG:
>CHANNEL 1          IN1
CHANNEL 2          IN2
CHANNEL 3          IN3
CHANNEL 4          IN4
CHANNEL 5          IN5
CHANNEL 6          IN6
CHANNEL 7          IN7 ↓
RANGE  AVG  DIAGS  ALARM
  
```

```

ANALOG INPUT 01 CONFIG:
>DESCRIPTOR          IN1
UNITS                V
DECIMAL PLACES      2
TABLE POINTS        2
POINT 1
POINT 2
RANGE  AVG  DIAGS  ALARM
  
```

Descriptor The Descriptor screen allows the user to enter the descriptor for the selected analog input channel. The descriptor is used in datalogging and streaming data to report what data is being sent out. The descriptor may be from 1 to 3 characters in length, and defaults to IN1 to IN8 (user input channel number).

- In the Main Menu, choose Instrument Controls > I/O Configuration > Analog Input Config > Select Channel > **Descriptor**.
- Press  to save the new descriptor.

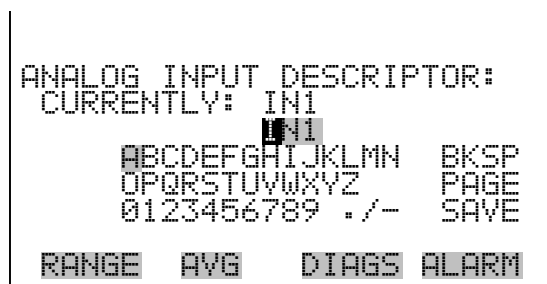

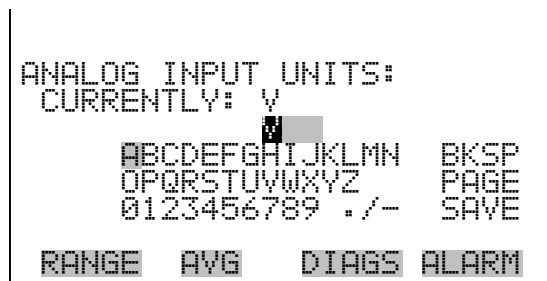

Units The Units screen allows the user to enter the units for the selected analog input channel. The units are displayed on the diagnostic screen and in datalogging and streaming data. The units may be from 1 to 3 characters in length, and defaults to V (volts).

- In the Main Menu, choose Instrument Controls > I/O Configuration > Analog Input Config > Select Channel > **Units**.
- Press  to save the new value.



Decimal Places



The Decimal Places screen allows the user to select how many digits are displayed to the right of the decimal, from 0 to 6, with a default of 2.

- In the Main Menu, choose Instrument Controls > I/O Configuration > Analog Input Config > Select Channel > **Decimal Places**.
- Use  and  to increment or decrement the value.
- Press  to save the new value.



Number of Table Points

The Number of Table Points screen allows the user to select how many points are used in the conversion table. The points range from 2 to 10, with a default of 2.

- In the Main Menu, choose Instrument Controls > I/O Configuration > Analog Input Config > Select Channel > **Table Points**.
- Use  and  to move the cursor up and down.
- Press  to save the new value.

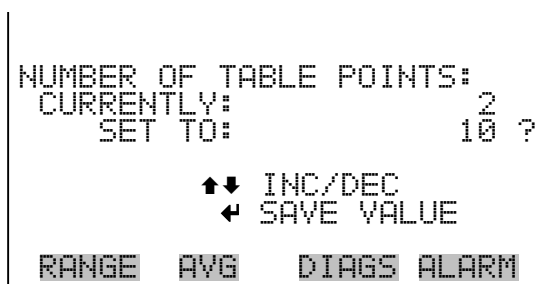





Table Point The Table Point submenu allows the user to set up an individual table point.

- In the Main Menu, choose Instrument Controls > I/O Configuration > Analog Input Config > Select Channel > **Point 1-10**.

```
TABLE POINT 01 CONFIG:
>VOLTS                0.00
USER VALUE            0.00

RANGE  AVG  DIAGS  ALARM
```

Volts The Volts screen allows the user to set the input voltage for the selected table point in the conversion table from 0.00 to 10.50. The default table is a two-point table with point 1: 0.00 V = 000.0 U and point 2: 10.00 V = 10.0 U.

- In the Main Menu, choose Instrument Controls > I/O Configuration > Analog Input Config > Select Channel > Select Point > **Volts**.
- Use  and  to move the cursor up and down.
- Press  to save the new value.



```
TABLE POINT 01 VOLTS:
CURRENTLY:            0.00
SET TO:              00.00

      ↔ MOVE CURSOR
↑↓ CHANGE VALUE      ← SAVE

RANGE  AVG  DIAGS  ALARM
```

User Value

The User Value screen allows the user to set the output value for the corresponding input voltage for the selected table point in the conversion table from -9999999 to 99999999. The default table is a two-point table with point 1: 0.00 V = 000.0 U and point 2: 10.00 V = 10.0 U.

- In the Main Menu, choose Instrument Controls > I/O Configuration > Analog Input Config > Select Table Point > **User Value**.
- Use  and  to move the cursor up and down.
- Press  to save the new value.

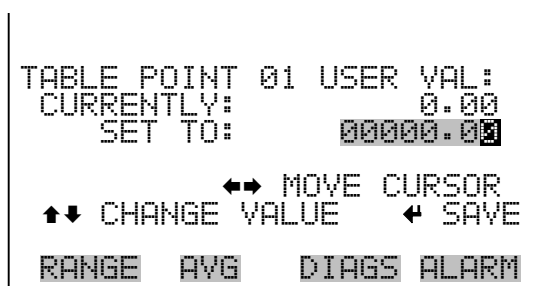

Temperature Compensation

Temperature compensation provides compensation for any changes to the instrument's output signal due to internal instrument temperature variations. The effects of internal instrument temperature changes on the analyzer's subsystems and output have been empirically determined. This empirical data is used to compensate for any changes in temperature. This compensation can be used for special applications, or when operating the instrument outside the recommended temperature range, even though the Model 42i High Level does not require temperature compensation for EPA equivalency.

When temperature compensation is on, the display shows the current internal instrument temperature (measured by a thermistor on the Interface board). When temperature compensation is off, the display shows the factory standard temperature of 30 °C.

- In the Main Menu, choose Instrument Controls > **Temperature Compensation**.
- Press  to toggle and set the temperature compensation on or off.

```
TEMPERATURE COMPENSATION:  
COMP TEMP:      30.0 °C  
CURRENTLY:      OFF  
SET TO:         ON ?  
  
← TOGGLE VALUE  
  
RANGE  AVG  DIAGS  ALARM
```

Pressure Compensation

Pressure compensation provides compensation for any changes to the instrument's output signal due to reaction chamber pressure variations. The effects of reaction chamber pressure changes on the analyzer's subsystems and output have been empirically determined. This empirical data is used to compensate for any change in reaction chamber pressure. This compensation can be used even though the Model 42i High Level does not require pressure compensation for EPA equivalency.



When pressure compensation is on, the first line of the display represents the current pressure in the reaction chamber. When pressure compensation is off, the first line of the display shows the factory standard pressure of 35 mmHg.

- In the Main Menu, choose Instrument Controls > **Pressure Compensation**.
- Press  to toggle and set the pressure compensation on or off.

```
PRESSURE COMPENSATION:  
COMP PRES:      35.0 mmHg  
CURRENTLY:      OFF  
SET TO:         ON ?  
  
← TOGGLE VALUE  
  
RANGE  AVG  DIAGS  ALARM
```

Screen Contrast

The Screen Contrast screen is used to change the contrast of the display. Intensities between 0 and 100% in increments of 10 are available. Changing the screen contrast may be necessary if the instrument is operated at extreme temperatures.

- In the Main Menu, choose Instrument Controls > **Screen Contrast**.
- Use  and  to increment or decrement the screen contrast.
- Press  to accept a change.

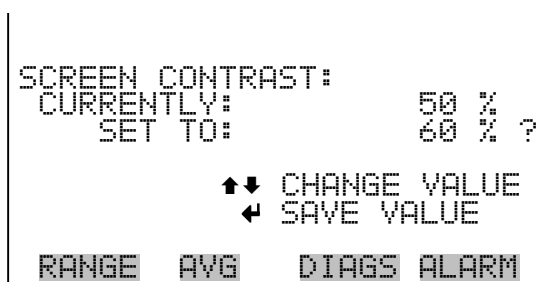

Service Mode

The Service Mode screen is used to turn the service mode on or off. The service mode locks out any remote actions and includes parameters and functions that are useful when making adjustments or diagnosing the Model 42i High Level. For more information about the service mode, see “Service Menu” later in this chapter.



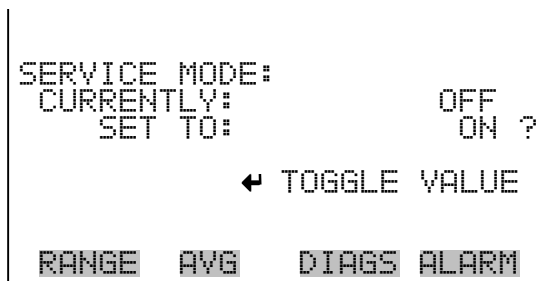

Note The service mode should be turned off when finished, as it prevents remote operation. ▲

- In the Main Menu, choose Instrument Controls > **Service Mode**.
- Press  to toggle and set the service mode on or off.



Date/Time

The Date/Time screen and allows the user to view and change the system date and time (24-hour format). The internal clock is powered by its own battery when instrument power is off.

- In the Main Menu, choose Instrument Controls > **Date/Time**.
- Use , ,  and  to move and change the value of the date and time.
- Press  to edit and save the new date and time.

```
DATE AND TIME:
19 MAR 2005 12:34:56
PRESS ← TO EDIT

RANGE  AVG  DIAGS  ALARM
```

```
DATE AND TIME:
19 MAR 2005 12:34:56  ?
SETTING: DAYS
  → SET MONTHS
  ↑↓ CHANGE VALUE
  ← SAVE VALUE

RANGE  AVG  DIAGS  ALARM
```

Diagnostics Menu

The Diagnostics menu provides access to diagnostic information and functions. This menu is useful when troubleshooting the instrument. The analog input readings and analog input voltages are displayed if the I/O expansion board option is installed.

- In the Main Menu, choose **Diagnostics**.

```
DIAGNOSTICS:
>PROGRAM VERSION
VOLTAGES
TEMPERATURES
PRESSURE
FLOW
ANALOG INPUT READINGS
ANALOG INPUT VOLTAGES ↓

RANGE  AVG  DIAGS  ALARM
```

```
DIGITAL INPUTS
RELAY STATES
TEST ANALOG OUTPUTS
INSTRUMENT CONFIGURATION
CONTACT INFORMATION
```

Program Version

The Program Version screen (read only) shows the version number of the program installed. Prior to contacting the factory with any questions regarding the instrument, please note the program version number.

- In the Main Menu, choose Diagnostics > **Program Version**.

```

PROGRAM VERSION:
PRODUCT:      MODEL 42iHL
VERSION:     01.00.01.074

RANGE  AVG  DIAGS  ALARM
  
```

Voltages

The Voltages menu displays the current diagnostic voltage readings. This screen enables the power supply to be quickly read for low or fluctuating voltages without having to use a voltage meter. The I/O board is displayed if the I/O expansion board option is installed.

- In the Main Menu, choose Diagnostics > **Voltages**.

```

VOLTAGES:
>MOTHERBOARD
INTERFACE BOARD
I/O BOARD

RANGE  AVG  DIAGS  ALARM
  
```

Motherboard Voltages

The Motherboard screen (read only) is used to display the current voltage readings on the motherboard.

- In the Main Menu, choose Diagnostics > Voltages > **Motherboard Voltages**.

```
MOTHERBOARD VOLTAGES:
 3.3 SUPPLY      3.3 V
 5.0 SUPPLY      5.0 V
15.0 SUPPLY     15.0 V
24.0 SUPPLY     24.0 V
-3.3 SUPPLY     -3.3 V

RANGE  AVG  DIAGS  ALARM
```

Interface Board Voltages

The Interface Board screen (read only) is used to display the current voltage readings on the interface board.

- In the Main Menu, choose Diagnostics > Voltages > **Interface Board Voltages**.

```
INTERFACE BOARD VOLTAGES:
PMT SUPPLY     785.5 V
 3.3 SUPPLY      3.3 V
 5.0 SUPPLY      5.0 V
15.0 SUPPLY     15.0 V
P15.0 SUPPLY    15.0 V
24.0 SUPPLY     24.0 V
-15.0 SUPPLY    -15.0 V

RANGE  AVG  DIAGS  ALARM
```

I/O Board Voltages

The I/O Board screen (read only) is used to display the current voltage readings on the I/O expansion board. This screen is displayed if the I/O expansion board option is installed.

- In the Main Menu, choose Diagnostics > Voltages > **I/O Board Voltages**.

```
I/O BOARD VOLTAGES:
 3.3 SUPPLY      3.3 V
 5.0 SUPPLY      5.0 V
15.0 SUPPLY     15.0 V
24.0 SUPPLY     24.0 V
-3.0 SUPPLY     -3.0 V

RANGE  AVG  DIAGS  ALARM
```

Temperatures

The Temperatures screen (read only) displays the internal temperature, reaction chamber temperature, cooler temperature, and converter temperatures. The internal temperature is the air temperature measured by a sensor located on the interface board.

- In the Main Menu, choose Diagnostics > **Temperatures**.

```

TEMPERATURES:
>INTERNAL          28.6 °C
CHAMBER           49.0 °C
COOLER            -2.8 °C
NO2 CONVERTER     625.0 °C
NO2 CONV SET      625.0 °C

RANGE  AVG  DIAGS  ALARM
  
```

Pressure

The Pressure screen (read only) displays the reaction chamber pressure. The pressure is measured by a pressure transducer at the reaction chamber.

- In the Main Menu, choose Diagnostics > **Pressure**.

```

CHAMBER PRES:    33.8 mmHg

RANGE  AVG  DIAGS  ALARM
  
```

Flow

The Flow screen (read only) displays the bypass flow rate (if the bypass flow option is installed) and ozonator flow rate. The flows are measured by internal flow sensors. For more information, see Chapter 1, “Introduction”.

- In the Main Menu, choose Diagnostics > **Flow**.

```
FLOW:          0.531 LPM
OZONATOR FLOW      OK

RANGE  AVG  DIAGS  ALARM
```

Analog Input Readings

The Analog Input Readings screen (read only) displays the 8 current user-scaled analog readings (if the I/O expansion board option is installed).

- In the Main Menu, choose Diagnostics > **Analog Input Readings**.

```
ANALOG INPUT READINGS:
>CO          10.2 PPM
SO2          18.2 PPB
CO2          250 PPM
FL1          20.42 LPM
WND          9.86 V
FL2          1.865 LPM
IO7          0.0 V↓

RANGE  AVG  DIAGS  ALARM
```

Analog Input Voltages

The Analog Input Voltages screen (read only) displays the 8 raw analog voltage readings (if the I/O expansion board option is installed).

- In the Main Menu, choose Diagnostics > **Analog Input Voltages**.

```
ANALOG INPUT VOLTAGES:
>ANALOG IN 1      6.24 V
ANALOG IN 2      4.28 V
ANALOG IN 3      0.00 V
ANALOG IN 4      0.00 V
ANALOG IN 5      0.00 V
ANALOG IN 6      0.00 V
ANALOG IN 7      0.00 V↓

RANGE  AVG  DIAGS  ALARM
```

Digital Inputs

The Digital Inputs screen (read only) displays the state of the 16 digital inputs.

- In the Main Menu, choose Diagnostics > **Digital Inputs**.

```

DIGITAL INPUTS:
>INPUT 1          1
INPUT 2          1
INPUT 3          1
INPUT 4          1
INPUT 5          1
INPUT 6          1
INPUT 7          1↓
RANGE  AVG  DIAGS  ALARM
  
```

Relay States

The Relay States screen displays the state of the 10 digital outputs and allows toggling of the state to either on (1) or off (0). The relays are restored to their original states upon exiting this screen.

- In the Main Menu, choose Diagnostics > **Relay States**.

```

RELAY STATE:
>OUTPUT 1          0
OUTPUT 2          0
OUTPUT 3          0
OUTPUT 4          1
OUTPUT 5          0
OUTPUT 6          0
OUTPUT 7          0↓
RANGE  AVG  DIAGS  ALARM
  
```

Test Analog Outputs



The Test Analog Outputs menu contains a number of digital to analog converter (DAC) calibration items. Channel choices include all analog outputs, 6 voltage channels, and 6 current channels (if the I/O expansion board option is installed).

- In the Main Menu, choose Diagnostics > **Test Analog Outputs**.

```
TEST ANALOG OUTPUTS:
>ALL
VOLTAGE CHANNEL 1
VOLTAGE CHANNEL 2
VOLTAGE CHANNEL 3
VOLTAGE CHANNEL 4
VOLTAGE CHANNEL 5
VOLTAGE CHANNEL 6
RANGE  AVG  DIAGS  ALARM
```

Set Analog Outputs

The Set Analog Outputs screen contains three choices: Set to full-scale, set to zero, or reset to normal. Full-scale sets the analog outputs to the full-scale voltage, zero sets the analog outputs to 0 volts, and normal operation. The example below shows the selected output state “ALL” is set to normal.

- In the Main Menu, choose Diagnostics > Test Analog Outputs > **ALL**, **Voltage Channel 1-6**, or **Current Channel 1-6**.
- Use  and  to move the cursor up and down.
- Press  to select a choice.

```
SET ANALOG OUTPUTS:
SETTING:                ALL
OUTPUT SET TO:         NORMAL
↑ SET TO FULL SCALE
↓ SET TO ZERO
← RESET TO NORMAL
RANGE  AVG  DIAGS  ALARM
```

Instrument Configuration

The Instrument Configuration screen displays information on the hardware configuration of the instrument.

Note If the analyzer is in service mode, pressing  on the item will toggle it yes or no. ▲

- In the Main Menu, choose Diagnostics > **Instrument Configuration**.
- Press  to toggle instrument configuration (in service mode only).

```

INSTRUMENT CONFIGURATION:
>I/O EXPANSION BOARD  YES
ZERO SPAN VALVES      YES
LAG VOLUME             YES
PERM DRYER             YES
BYPASS FLOW            YES
CONVERTER              SS
DILUTION               NO↓

RANGE  AVG  DIAGS  ALARM

AUTO CALIBRATION      NO
  
```

Contact Information

The Contact Information screen displays the customer service information.

- In the Main Menu, choose Diagnostics > **Contact Information**.

```

CONTACT INFORMATION:
CALL CENTER: 508-520-0430
WEB:        WWW.THERMO.COM

RANGE  AVG  DIAGS  ALARM
  
```

Alarms Menu

The alarms menu displays a list of items that are monitored by the analyzer. If the item being monitored goes outside the lower or upper limit, the status of that item will go from “OK” to either “LOW” or “HIGH”, respectively. If the alarm is not a level alarm, the status will go from “OK” to “FAIL”. The number of alarms detected is displayed to indicate how many alarms have occurred. If no alarms are detected, the number zero is displayed.

To see the actual reading of an item and its minimum and maximum limits, move the cursor to the item and press .

The zero/span check and auto calibration screens are displayed if the zero/span check or auto calibration options are enabled. The motherboard status, interface board status, and I/O expansion board status (if installed) indicates that the power supplies are working and connections are successful. There are no setting screens for these alarms.

- In the Main Menu, choose **Alarms**.

```
ALARMS:
ALARMS DETECTED          0
> INTERNAL TEMP          OK
CHAMBER TEMP             OK
COOLER TEMP              OK
CONVERTER TEMP           OK
PRESSURE                  OK
FLOW                      OK ↓
RANGE  AVG  DIAGS  ALARM
```

```
OZONATOR FLOW           OK
ZERO CHECK               OK
SPAN CHECK               OK
ZERO AUTOCAL             OK
SPAN AUTOCAL             OK
NO CONCENTRATION        OK
NO2 CONCENTRATION       OK
NOx CONCENTRATION       OK
MOTHERBOARD STATUS     OK
INTERFACE STATUS        OK
I/O EXP STATUS           OK
```

Internal Temperature

The Internal Temperature screen displays the current internal temperature and sets the minimum and maximum alarm limits. Acceptable alarm limits range from 8 to 47 °C. If the internal temperature reading goes beyond either the minimum or maximum alarm limit, an alarm is activated. The word “ALARM” appears in the Run screen and in the Main Menu.

- In the Main Menu, choose Alarms > **Internal Temp**.



```

INTERNAL TEMPERATURE:
ACTUAL                28.6 °C
>MIN                 15.0 °C
MAX                  45.0 °C

RANGE  AVG  DIAGS  ALARM
  
```

Min and Max Internal Temperature Limits

The Minimum Internal Temperature alarm limit screen is used to change the minimum internal temperature alarm limit. The minimum and maximum internal temperature screens function the same way.

- In the Main Menu, choose Alarms > Internal Temp > **Min** or **Max**.
- Use  and  to increment or decrement the numeric value.
- Press  to save set to value as actual value.

```

INTERNAL TEMPERATURE:
ACTUAL MIN:          15.0 °C
SET MIN TO:         16.0 °C ?

  ↑↓ INC/DEC
  ← SAVE VALUE

RANGE  AVG  DIAGS  ALARM
  
```

Chamber Temperature

The Chamber Temperature screen displays the current chamber temperature and sets the minimum and maximum alarm limits. Acceptable alarm limits range from 47 to 51 °C. If the chamber temperature reading goes beyond either the minimum or maximum limit, an alarm is activated. The word “ALARM” appears in the Run screen and in the Main Menu.



- In the Main Menu, choose Alarms > **Chamber Temp.**

```
CHAMBER TEMPERATURE:
ACTUAL                49.0 °C
>MIN                  47.0 °C
MAX                   51.0 °C

RANGE  AVG  DIAGS  ALARM
```

Min and Max Chamber Temperature Limits

The Minimum Chamber Temperature alarm limit screen is used to change the minimum chamber temperature alarm limit. The minimum and maximum internal temperature screens function the same way.

- In the Main Menu, choose Alarms > Chamber Temp > **Min** or **Max**.
- Use  and  to increment or decrement the numeric value.
- Press  to save set to value as actual value.

```
CHAMBER TEMPERATURE:
ACTUAL MIN:          47.0 °C
SET MIN TO:         48.0 °C ?

  ↑↓ INC/DEC
  ← SAVE VALUE

RANGE  AVG  DIAGS  ALARM
```

Cooler Temperature

The Cooler Temperature screen displays the current cooler temperature and sets the minimum and maximum alarm limits. Acceptable alarm limits range from -25 to -1 °C. If the cooler temperature reading goes beyond either the minimum or maximum limit, an alarm is activated. The word “ALARM” appears in the Run screen and in the Main Menu.

- In the Main Menu, choose Alarms > Cooler Temp.



```

COOLER TEMPERATURE:
ACTUAL                -2.8 °C
>MIN                  -10.0 °C
MAX                   -1.0 °C

RANGE  AVG  DIAGS  ALARM
  
```

Min and Max Cooler Temperature Limits

The Minimum Cooler Temperature alarm limit screen is used to change the minimum cooler temperature alarm limit. The minimum and maximum cooler temperature screens function the same way.

- In the Main Menu, choose Alarms > Cooler Temp > **Min** or **Max**.
- Use  and  to increment or decrement the numeric value.
- Press  to save set to value as actual value.

```

COOLER TEMPERATURE:
ACTUAL MIN:          -10.0 °C
SET MIN TO:          -9.0 °C ?

  ↑↓ INC/DEC
  ← SAVE VALUE

RANGE  AVG  DIAGS  ALARM
  
```

Converter Temperature

The Converter Temperature screen displays the current converter temperature and sets the minimum and maximum alarm limits. Acceptable alarm limits range from 300 to 700 °C. The actual alarm setpoints should be set for the installed converter. If the converter temperature reading goes beyond either the minimum or maximum limit, an alarm is activated. The word “ALARM” appears in the Run screen and in the Main Menu.

- In the Main Menu, choose Alarms > **Converter Temp.**

```
CONVERTER TEMPERATURE:
ACTUAL                625.0 °C
>MIN                 600.0 °C
MAX                  650.0 °C

RANGE  AVG  DIAGS  ALARM
```

Min and Max Converter Temperature Limits

The Minimum Converter Temperature alarm limit screen is used to change the minimum converter temperature alarm limit. The minimum and maximum converter temperature screens function the same way.

Note The ozonator will not turn on if the converter is below alarm limit. ▲

- In the Main Menu, choose Alarms > Converter Temp > **Min** or **Max**.
- Use and to increment or decrement the numeric value.
- Press to save set to value as actual value.

```
CONVERTER TEMPERATURE:
ACTUAL MIN:          600.0 °C
SET MIN TO:          610.0 °C ?

  ↑↓ INC/DEC
  ← SAVE VALUE

RANGE  AVG  DIAGS  ALARM
```

Pressure

The Pressure screen displays the current reaction chamber pressure reading and sets the minimum and maximum alarm limits. Acceptable alarm limits range from 20 to 100 mmHg. If the pressure reading goes beyond either the minimum or maximum limit, an alarm is activated. The word “ALARM” appears in the Run screen and in the Main Menu.

- In the Main Menu, choose Alarms > **Pressure**.



```

PRESSURE:
ACTUAL          33.8 mmHg
>MIN           20.0 mmHg
MAX            100.0 mmHg

RANGE  AVG  DIAGS  ALARM
  
```

Min and Max Pressure Limits

The Minimum Pressure alarm limit screen is used to change the minimum pressure alarm limit. The minimum and maximum pressure screens function the same way.

- In the Main Menu, choose Alarms > Pressure > **Min** or **Max**.
- Use  and  to increment or decrement the numeric value.
- Press  to save set to value as actual value.

```

PRESSURE:
ACTUAL MIN:    20.0 mmHg
SET MIN TO:   30.0 mmHg?

  ↑↓ INC/DEC
  ← SAVE VALUE

RANGE  AVG  DIAGS  ALARM
  
```

Flow The Flow screen displays the current bypass flow reading (if the bypass flow option is installed) and sets the minimum and maximum alarm limits. Acceptable alarm limits range from 0 to 1 LPM. If the sample flow reading goes beyond either the minimum or maximum limit, an alarm is activated. The word “ALARM” appears in the Run screen and in the Main Menu.



- In the Main Menu, choose Alarms > **Flow**.

```
FLOW:
ACTUAL          0.531 LPM
>MIN           0.350 LPM
MAX           0.900 LPM

RANGE  AVG  DIAGS  ALARM
```

Min and Max Flow Limits

The Minimum Flow alarm limit screen is used to change the minimum sample flow alarm limit. The minimum and maximum sample flow screens function the same way.

- In the Main Menu, choose Alarms > Flow > **Min** or **Max**.
- Use  and  to increment or decrement the numeric value.
- Press  to save set to value as actual value.

```
FLOW:
ACTUAL MIN:    0.350 LPM
SET MIN TO:    0.360 LPM ?

  ↑↓ INC/DEC
  ← SAVE VALUE

RANGE  AVG  DIAGS  ALARM
```

Ozonator Flow

The Ozonator Flow screen (read only) is used to display the ozonator flow readings. If the ozonator flow reading is 0.050 LPM (50 cc) or below, an alarm is activated, and an alarm condition screen appears as “LOW”. If the ozonator flow is above 0.050 LPM, the no alarm condition screen is

displayed, indicating that the flow is acceptable. Inadequate ozonator flow will cause the ozonator to overheat, resulting in permanent damage to the ozonator.

- In the Main Menu, choose Alarms > **Ozonator Flow**.

```

OZONATOR FLOW:
ACTUAL          > 0.050 LPM

RANGE  AVG  DIAGS  ALARM
  
```

Zero and Span Check

The Zero Span Check screen allows the user to view the status of the most recent zero check and set the maximum zero check offset. The zero and span check screens are displayed if the zero/span check option is enabled and function the same way.

- In the Main Menu, choose Alarms > **Zero or Span Check**.

```

ZERO CHECK:
ALARM:                OK
RESPONSE:             0.00
>MAX OFFSET:         10.00

RANGE  AVG  DIAGS  ALARM
  
```

Max Zero and Span Offset

The Max Zero Check Offset screen is used to change the maximum zero check offset. The maximum zero and span offset screens function the same way.

- In the Main Menu, choose Alarms > Zero or Span Check > **Max Offset**.
- Use and to increment or decrement the numeric value.
- Press to save set to value as actual value.

```
MAX ZERO CHECK OFFSET:
CURRENTLY:           10.00
SET TO:              11.00 ?

      ↑↓ CHANGE VALUE
      ←  SAVE VALUE

RANGE  AVG  DIAGS  ALARM
```

Zero and Span Auto Calibration

The Zero Auto Calibration screen (read only) allow the user to view the status of the most recent auto background calibration. The zero and span auto calibration screens are displayed if the auto calibration option is installed and function the same way.

- In the Main Menu, choose Alarms > **Zero** or **Span Autocal**.

```
ZERO AUTO CALIBRATION:
ALARM:                OK
RESPONSE:             5.00

RANGE  AVG  DIAGS  ALARM
```

NO, NO₂, and NO_x Concentration

The NO Concentration screen displays the current NO concentration and sets the minimum and maximum alarm limits. Acceptable alarm limits range from 0 to 5,000 ppm and 0 to 7,500 mg/m³. The minimum alarm may be programmed as a floor trigger (alarm is triggered when the concentration falls below the minimum value) or a ceiling trigger (alarm is triggered when the concentration goes above the minimum value). If the NO concentration goes beyond either the minimum or maximum limit, an alarm is activated. The word “ALARM” appears in the Run screen and in the Main Menu. The NO₂ and NO_x Concentration screens function the same way.

- In the Main Menu, choose Alarms > **NO, NO₂ or NO_x Concentration**.



```

NO CONCENTRATION:
ACTUAL                62.7
>MIN                 0
MAX                 5000
MIN TRIGGER          CEILING

RANGE  AVG  DIAGS  ALARM
  
```

Min and Max NO, NO₂, and NO_x Concentration Limits

The Minimum NO Concentration alarm limit screen is used to change the minimum NO concentration alarm limit. The minimum and maximum NO, NO₂, and NO_x concentration alarm limit screens function the same way.

- In the Main Menu, choose Alarms > Select Concentration > **Min** or **Max**.
- Use  and  to increment or decrement the numeric value.
- Press  to save set to value as actual value.

```

NO CONCENTRATION:
ACTUAL MIN:          0
SET MIN TO:         00000000L ?

      ←→ MOVE CURSOR
↑↓ INC/DEC  ← SAVE VALUE

RANGE  AVG  DIAGS  ALARM
  
```

Min Trigger

The Minimum Trigger screen allows the user to view and set the NO, NO₂, and NO_x concentration low alarm trigger type to either floor or ceiling. The minimum alarm may be programmed as a floor trigger (alarm is triggered when the concentration falls below the minimum value) or a ceiling trigger (alarm is triggered when the concentration goes above the minimum value).

- In the Main Menu, choose Alarms > Select Concentration > **MinTrigger**.
- Press  to toggle and set to floor or ceiling.

```
MIN_TRIG<CEILING/FLOOR>:  
ACTUAL_TRIGGER: CEILING  
SET_TRIGGER_TO: FLOOR ?  
  
← TOGGLE AND SAVE VALUE  
RANGE  AVG  DIAGS  ALARM
```

Service Menu

The Service menu appears only when the instrument is in the service mode. To put the instrument into service mode:

- In the Main Menu, choose Instrument Controls > **Service Mode**.
- Press  to toggle and set the service mode on.

Advanced diagnostic functions are included in the service mode. Meaningful data should not be collected when the instrument is in the service mode.

- In the Main Menu, choose **Service**.

```
SERVICE:  
>PMT VOLTAGE ADJUSTMENT  
RANGE MODE SELECT  
CONVERTER SET TEMP  
PRESSURE CALIBRATION  
FLOW CALIBRATION  
INPUT BOARD CALIBRATION  
TEMPERATURE CALIBRATION ↓  
RANGE  AVG  DIAGS  ALARM
```



```
ANALOG OUT CALIBRATION  
ANALOG INPUT CALIBRATION  
OZONATOR SAFETY  
DILUTION RATIO  
DISPLAY PIXEL TEST  
RESTORE USER DEFAULTS
```

PMT Voltage Adjustment

The PMT Voltage Adjustment screen is used to manually adjust the PMT supply voltage. The PMT voltage adjustment screen is visible only when the instrument is in service mode. For more information on the service mode, see “Service Mode” earlier in this chapter.



WARNING This adjustment should only be performed by an instrument service technician. ▲

- In the Main Menu, choose Service > **PMT Voltage Adjustment**.
- Use  and  to increment or decrement the PMT counts.
- Press  to save the new PMT voltage.

```



SET PMT VOLTAGE:
SET PMT:          750.0 V
COUNTS:         2254 ?

      ↑↓ INC/DEC
      ← SAVE VALUE

RANGE  AVG  DIAGS  ALARM
  
```

Range Mode Select

The Range Mode Select screen is used to switch between the various range modes: single, dual, and auto range. The range mode select screen is visible only when the instrument is in service mode. For more information on the service mode, see “Service Mode” earlier in this chapter.

- In the Main Menu, choose Service > **Range Mode Select**.
- Use  and  to scroll through a list of choices.
- Press  to save the new range mode.

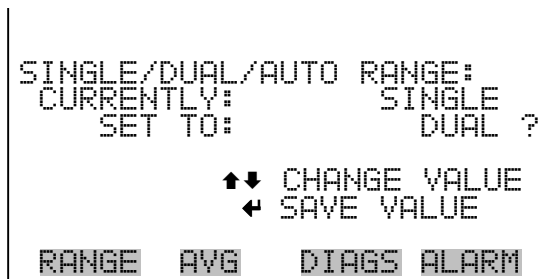



Converter Set Temperature

The Converter Set Temperature screen is used to change the converter set temperature. The converter set temperature reading is updated every second. The converter set temperature screen is visible only when the instrument is in service mode. For more information on the service mode, see “Service Mode” earlier in this chapter.



WARNING This adjustment should only be performed by an instrument service technician. ▲

- In the Main Menu, choose Service > **Converter Set Temperature**.
- Use  and  to increment or decrement the numeric values.
- Press  to save the new set temperature.

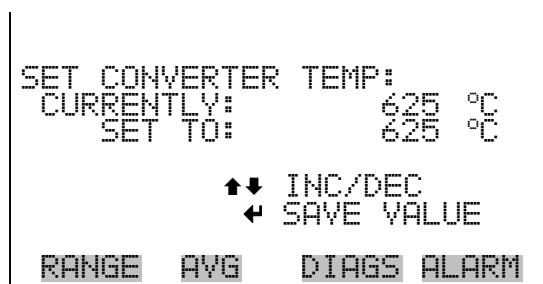

Pressure Calibration

The Pressure Calibration menu is used to calibrate the pressure sensor to zero, span, or restore factory default values. The pressure calibration menu is visible only when the instrument is in service mode. For more information on the service mode, see “Service Mode” earlier in this chapter.

The pressure sensor's zero counts and span slope are displayed on the menu.



WARNING This adjustment should only be performed by an instrument service technician. ▲

- In the Main Menu, choose Service > **Pressure Calibration**.

```

PRESSURE SENSOR CAL:
>ZERO                72
SPAN                 1.1447
SET DEFAULTS

RANGE  AVG  DIAGS  ALARM
  
```

Calibrate Pressure Zero

The Calibrate Pressure Zero screen calibrates the pressure sensor at zero pressure.

Note A vacuum pump must be connected to the pressure sensor before performing the zero calibration. ▲

- In the Main Menu, choose Service > Pressure Calibration > **Zero**.
- Press  to save the current pressure reading as the zero reading.

```

CALIBRATE PRESSURE ZERO:
CURRENTLY:          33.8 mmHg
SET TO:             0.0 mmHg ?





CONNECT VACUUM PUMP AND
← SAVE ZERO PRESSURE

RANGE  AVG  DIAGS  ALARM
  
```

Calibrate Pressure Span

The Calibrate Pressure Span screen allows the user to view and set the pressure sensor calibration span point.



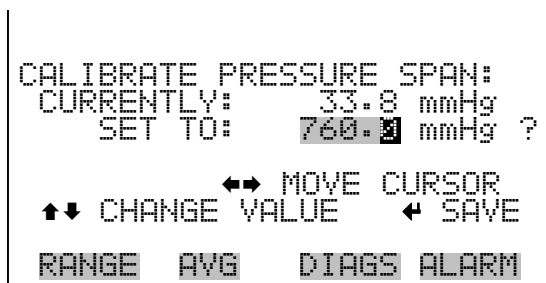

Note The plumbing going to the pressure sensor should be disconnected so the sensor is reading ambient pressure before performing the span calibration. The operator should use an independent barometer to measure the ambient pressure and enter the value on this screen before calibrating. ▲

- In the Main Menu, choose Service > Pressure Calibration > **Span**.
- Use , ,  and  to move and change the value.
- Press  to save set to value as actual value.



Restore Default Pressure Calibration

The Restore Default Pressure Calibration screen allows the user to reset the pressure calibration configuration values to factory defaults.

- In the Main Menu, choose Service > Pressure Calibration > **Set Defaults**.
- Press  to warn user and enable restore with .
- Use  to overwrite pressure sensor calibration parameters with factory default values when pressed after .

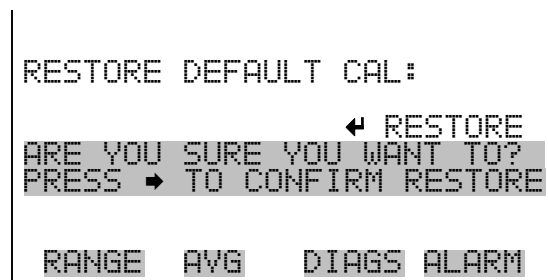
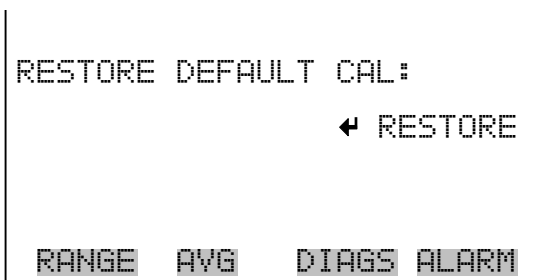

Flow Calibration

The Flow Calibration menu is used to calibrate the flow sensor to zero, span, or restore factory default values. The flow calibration menu is visible only when the instrument is in service mode. For more information on the service mode, see “Service Mode” earlier in the chapter.



WARNING This adjustment should only be performed by an instrument service technician. ▲

- In the Main Menu, choose Service > **Flow Calibration**.

```

FLOW SENSOR CAL:
>ZERO                200
SPAN                 1.0000
SET DEFAULTS

RANGE  AVG  DIAGS  ALARM
  
```

Calibrate Flow Zero

The Calibrate Flow Zero screen calibrates the flow sensor at zero flow.

Note The pump must be disconnected before performing the zero calibration. ▲

- In the Main Menu, choose Service > Flow Calibration > **Zero**.
- Press  to save the current flow reading as the zero reading.

```

CALIBRATE FLOW ZERO:
CURRENTLY:    0.004 LPM
SET TO:      0.000 LPM ?





DISCONNECT PUMP AND
← SAVE ZERO PRESSURE

RANGE  AVG  DIAGS  ALARM
  
```

Calibrate Flow Span

The Calibrate Flow Span screen allows the user to view and set the flow sensor calibrate span point.

Note An independent flow sensor is required to read the flow, then the operator enters the flow value on this screen to perform the calibration. ▲

- In the Main Menu, choose Service > Flow Calibration > **Span**.
- Use , ,  and  to move and change the value.
- Press  to save set to value as actual value.

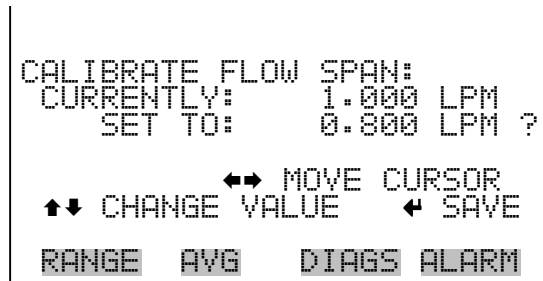





```
CALIBRATE FLOW SPAN:
CURRENTLY: 1.000 LPM
SET TO: 0.800 LPM ?

      ←→ MOVE CURSOR
↑↓ CHANGE VALUE  ← SAVE

RANGE  AVG  DIAGS  ALARM
```

Restore Default Flow Calibration

The Restore Default Flow Calibration screen allows the user to reset the flow calibration configuration values to factory defaults.

- In the Main Menu, choose Service > Flow Calibration > **Set Defaults**.
- Press  to warn user and enable restore with .
- Use  to overwrite pressure sensor calibration parameters with factory default values when pressed after .

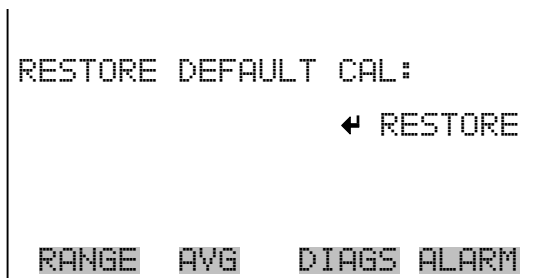

```
RESTORE DEFAULT CAL:
      ← RESTORE

RANGE  AVG  DIAGS  ALARM
```

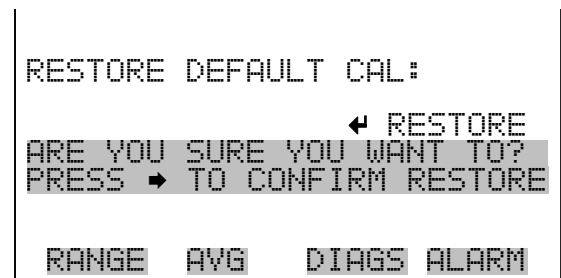

```
RESTORE DEFAULT CAL:
      ← RESTORE
ARE YOU SURE YOU WANT TO?
PRESS → TO CONFIRM RESTORE

RANGE  AVG  DIAGS  ALARM
```

Input Board Calibration

The Input Board Calibration menu is used to initiate a calibration of the input A/D stages. The input board calibration menu is visible only when the instrument is in service mode. For more information on the service mode, see “Service Mode” on page.



WARNING This adjustment should only be performed by an instrument service technician. ▲

- In the Main Menu, choose Service > **Input Board Calibration**.

```

INPUT BOARD CALIBRATION:
>MANUAL INPUT CAL
  AUTOMATIC INPUT CAL
  INPUT FREQUENCY DISP

RANGE  AVG  DIAGS  ALARM
  
```





Manual Input Calibration

The Manual Input Calibration screen is used to do a manual calibration of the input board A/D stages.



WARNING This adjustment should only be performed by an instrument service technician. ▲

Note The measurement system and the PMT are both shut off inside this screen. ▲

- In the Main Menu, choose Service > Input Board Calibration > **Manual Input Cal**.
- Press  to leave warning screen.
- Make a note of the frequency at gain of 1.
- Use  and  to change the gain between 10 and 100.
- Use  and  to increment or decrement the D/A counts so the frequency at gain 100 is equal to the frequency at gain 1.

- Press  to save new input board calibration.

```
INPUT BOARD CALIBRATION:
  ← TO CALIBRATE
** WARNING **
THIS ACTION MAY REQUIRE
RECALIBRATION OF THE
ENTIRE MEASUREMENT SYSTEM!
RANGE  AVG  DIAGS  ALARM
```

```
GAIN 1  - MANUAL:
      FREQ =  4500
      D/A  =   N/A  ?
↔ CHG GAIN      ← SAVE VALUES
RANGE  AVG  DIAGS  ALARM
```

Automatic Input Calibration

The Automatic Input Calibration screen is used to do a automatic calibration of the input board A/D stages.



WARNING This adjustment should only be performed by an instrument service technician. ▲

Note The measurement system and the PMT are both shut off inside this screen. ▲





- In the Main Menu, choose Service > Input Board Calibration > **Automatic Input Cal.**
- Press  to leave warning screen and begin automatic calibration.

```
INPUT BOARD CALIBRATION:
  ← TO CALIBRATE
** WARNING **
THIS ACTION MAY REQUIRE
RECALIBRATION OF THE
ENTIRE MEASUREMENT SYSTEM!
RANGE  AVG  DIAGS  ALARM
```

```
INPUT BOARD CALIBRATION:
** IN PROGRESS **
D/A   =  2047
TARGET =  0
FREQ  =  0      0
ZERO  =  0 CNT =  1
RANGE  AVG  DIAGS  ALARM
```

Input Frequency Display

The Frequency Display screen is used to manually adjust the input board gain. This may be used as a troubleshooting tool for the input board. The gain setting and test mode are reset upon exiting this screen.

- In the Main Menu, choose Service > Input Board Calibration > **Frequency Disp.**
- Press  to leave warning screen.
- Use  and  to toggle the test signal and bypass the PMT.
- Use  and  to change the gain between 1, 10, and 100.

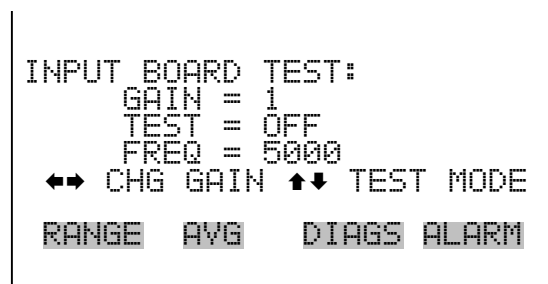





Temperature Calibration

The Temperature calibration screen allows the user to view and set the ambient temperature sensor calibration. The temperature calibration screen is visible only when the instrument is in service mode. For more information on the service mode, see “Service Mode” earlier in the chapter.



WARNING This adjustment should only be performed by an instrument service technician. ▲

- In the Main Menu, choose Service > **Temperature Calibration.**
- Use , ,  and  to move and change the value.
- Press  to save set to value as actual value.

```
CALIBRATE AMBIENT TEMP:
CURRENTLY:      28.6 °C
SET TO:         25.0 °C ?

      ←→ MOVE CURSOR
↑↓ CHANGE VALUE  ← SAVE

RANGE  AVG  DIAGS  ALARM
```

Analog Output Calibration

The Analog Output Calibration menu is a selection of 6 voltage channels and 6 current channels (if I/O expansion board option is installed) to calibrate, and allows the user to select the calibration action zero or span. The analog output calibration menu is visible only when the instrument is in service mode. For more information on the service mode, see “Service Mode” earlier in the chapter.



WARNING This adjustment should only be performed by an instrument service technician. ▲

- In the Main Menu, choose Service > **Analog Out Calibration**.

```
ANALOG OUTPUT CAL:
>VOLTAGE CHANNEL 1
VOLTAGE CHANNEL 2
VOLTAGE CHANNEL 3
VOLTAGE CHANNEL 4
VOLTAGE CHANNEL 5
VOLTAGE CHANNEL 6
CURRENT CHANNEL 1      ↓



RANGE  AVG  DIAGS  ALARM
```

```
ANALOG OUTPUT CAL:
>CALIBRATE ZERO
CALIBRATE FULL SCALE

RANGE  AVG  DIAGS  ALARM
```

Analog Output Calibrate Zero

The Analog Output Calibrate Zero screen allows the user to calibrate the zero state of the selected analog output. The operator must connect a meter to the output and adjust the output until it reads 0.0 V on the meter.

- In the Main Menu, choose Service > Analog Out Calibration > Select Channel > **Calibrate Zero**.
- Use  and  to increment or decrement the numeric value.
- Press  to save the value.



```

ANALOG OUTPUT CAL:  ZERO
CONNECT METER TO OUTPUT!
SELECTED OUTPUT:    V1
SET TO:             101 ?
← SAVE VALUE      ↑↓ INC/DEC
SET OUTPUT TO:     0.0 V

RANGE  AVG  DIAGS  ALARM
  
```

Analog Output Calibrate Full-Scale

The Analog Output Calibrate Full-Scale screen allows the user to calibrate the full-scale state of the selected analog output. The operator must connect a meter to the output and adjust output until it reads the value shown in the set output to: field.

- In the Main Menu, choose Service > Analog Out Calibration > Select Channel > **Calibrate Full Scale**.
- Use  and  to increment or decrement the numeric value.
- Press  to save the value.

```

ANALOG OUTPUT CAL:  SPAN
CONNECT METER TO OUTPUT!
SELECTED OUTPUT:    V1
SET TO:             3697 ?
← SAVE VALUE      ↑↓ INC/DEC
SET OUTPUT TO:     10 V

RANGE  AVG  DIAGS  ALARM
  
```

Analog Input Calibration

The Analog Input Calibration menu is a selection of 8 analog inputs (if the I/O expansion board option is installed) to calibrate, and allows the user to select the calibration action zero or span. The analog input calibration menu is visible only when the instrument is in service mode. For more information on the service mode, see “Service Mode” earlier in the chapter.



WARNING This adjustment should only be performed by an instrument service technician. ▲

- In the Main Menu, choose Service > **Analog Input Calibration**.

```
ANALOG INPUT CAL:
>INPUT CHANNEL 1
  INPUT CHANNEL 2
  INPUT CHANNEL 3
  INPUT CHANNEL 4
  INPUT CHANNEL 5
  INPUT CHANNEL 6
  INPUT CHANNEL 7
                                     ↓
RANGE  AVG  DIAGS  ALARM
```

```
ANALOG INPUT CAL:
>CALIBRATE ZERO
  CALIBRATE FULL SCALE

RANGE  AVG  DIAGS  ALARM
```

Analog Input Calibrate Zero

The Analog Input Calibrate Zero screen allows the user to calibrate the zero state of the selected analog input.

In the Main Menu, choose Service > Analog Input Calibration > Select Channel > **Calibrate Zero**. (Hook up a voltage source of 0 V to the analog input channel.)

- Press  to save the value.

```

ANALOG INPUT CAL:  ZERO
DISCONNECT SELECTED INPUT!
SELECTED INPUT:  INPUT 1
CURRENTLY:  6.24 V

← CALIBRATE INPUT TO ZERO

RANGE  AVG  DIAGS  ALARM
  
```

Analog Input Calibrate Full-Scale

The Analog Input Calibration Full-Scale screen allows the user to calibrate the full-scale state of the selected analog input.

- In the Main Menu, choose Service > Analog Input Calibration > Select Channel > **Calibrate Full Scale**. (Hook up a voltage source of 10 V to the analog input channel.)
- Use and to increment or decrement the numeric value.
- Press to save the value.

```

ANALOG INPUT CAL:  SPAN
PROVIDE VOLTAGE TO INPUT!
SELECTED INPUT:  INPUT 1
CURRENTLY:  6.24 V
SET TO:  10.00 V
← CALIBRATE TO VALUE

RANGE  AVG  DIAGS  ALARM
  
```

Ozonator Safety

The Ozonator Safety screen is used to turn the ozonator safety feature on and off. If the ozonator safety is turned off, the ozonator will always be on, even if there is no flow or the converter is not up to temperature. The ozonator safety screen is visible only when the instrument is in service mode. For more information on the service mode, see “Service Mode” earlier in the chapter.

- In the Main Menu, choose Service > **Ozonator Safety**.
- Press to toggle and set the service mode on or off.

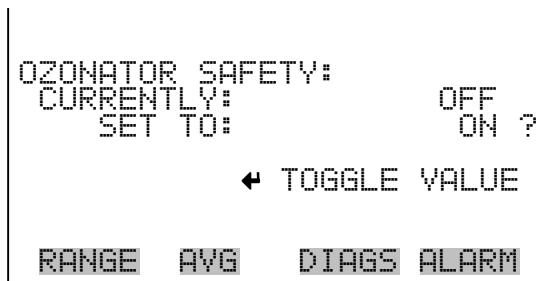

Dilution Ratio

The Dilution Ratio screen allows the user to view and set the dilution ratio. Acceptable values are 1–500: 1. The default is 1:1. When this value is set, the dilution ratio is applied to all concentration measurements. This screen is displayed if the dilution ratio option is installed.

- In the Main Menu, choose Service > **Dilution Ratio**.
- Use , , , and to move and change the value.
- Press to save set to value as actual value.

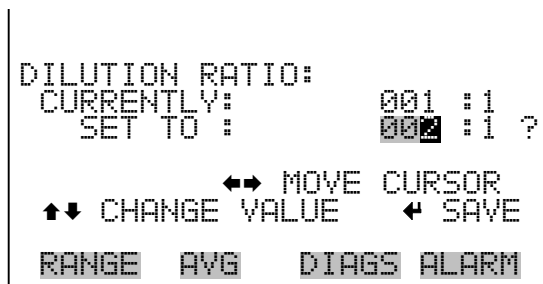

Display Pixel Test

The Display Pixel Test is used to test the LCD display. The display pixel test screen is visible only when the instrument is in service mode. For more information on the service mode, see “Service Mode” earlier in the chapter.

- In the Main Menu, choose Service > **Display Pixel Test**.
- Press to begin test by turning all pixels on, then toggle between on or off.

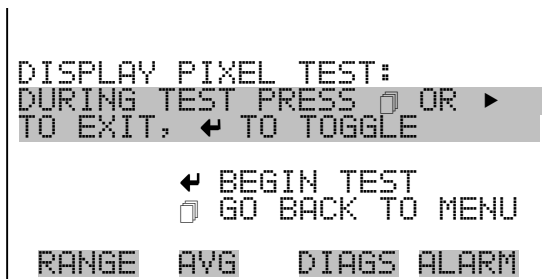

Restore User Defaults

The Restore User Defaults screen is used to reset the user calibration and configuration values to factory defaults. The restore user defaults screen is visible only when the instrument is in service mode. For more information on the service mode, see “Service Mode” earlier in the chapter.

Note When this item is selected, the instrument will be automatically rebooted after restoring defaults. ▲

- In the Main Menu, choose Service > **Restore User Defaults**.
- Press to warn and enable restore with .
- Press to overwrite all user settings with factory default values.

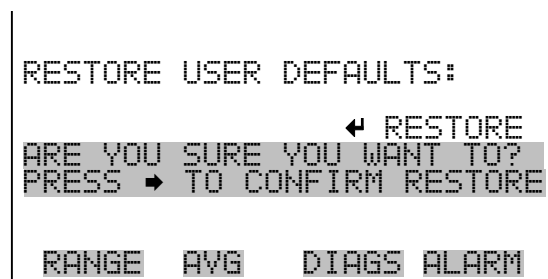

Password

The Password menu allows the user to configure password protection. If the instrument is locked, none of the settings may be changed via the front panel user interface. The items visible under the password menu are determined by the instrument's password status.

- In the Main Menu, choose **Password**.

```
PASSWORD MENU:  
>SET PASSWORD  
LOCK INSTRUMENT  
CHANGE PASSWORD  
REMOVE PASSWORD  
UNLOCK INSTRUMENT  
  
RANGE  AVG  DIAGS  ALARM
```

Set Password

The Set Password screen is used to set the password to unlock the front panel. The set password is shown if the instrument is unlocked and the password not set.

- In the Main Menu, choose Password > **Set Password**.
- Press  to enter password and disable instrument lock.

```
ENTER NEW PASSWORD:  
          █  
ABCDEF GHIJKLMN  BKSP  
OPQRST UVWXYZ   PAGE  
012345 6789  . / -  SAVE  
  
RANGE  AVG  DIAGS  ALARM
```

Lock Instrument

The Lock Instrument screen is used to lock the instrument's front panel so users can not change any settings from the front panel. The lock instrument is shown if the instrument is unlocked and the password set.

- In the Main Menu, choose Password > **Lock Instrument**.
- Press  to enable instrument lock and returns to main menu.



Change Password

The Change Password is used to change the password used to unlock the instrument's front panel. The change password is shown if the instrument is unlocked.

- In the Main Menu, choose Password > **Change Password**.
- Press  to change password.



Remove Password

The Remove Password screen is used to erase the current password and disable password protection. The remove password is shown if the instrument is unlocked and the password set.

- In the Main Menu, choose Password > **Remove Password**.
- Press  to remove password and returns to main menu.



Unlock Instrument

The Unlock Instrument screen is used to enter the password to unlock the front panel. The Unlock Instrument is shown if the instrument is locked.

- In the Main Menu, choose Password > **Unlock Instrument**.
- Press  to disable instrument lock and returns to main menu.



Chapter 4 Calibration

This chapter describes procedures for performing a calibration of the Model 42*i* High Level. The information described here should be adequate to perform the calibration. However, if greater detail is desired, due to particular application requirements, the factory should be consulted.

Equipment Required



A zero air source, free of contaminants such as NO, NO₂, and O₃ is required for dilution, calibration, and gas phase titration. This can be a cylinder of zero gas, a scrubbed, compressed air source, or room air, depending on the concentration of NO_x to be measured and the level of NO_x in the ambient area.



Pre-Calibration

Use the following procedure before calibrating the Model 42*i* High Level. For detailed information about the menu parameters and the icons used in these procedures, see the “Operation” chapter.





Note The calibration and calibration check duration times should be long enough to account for the transition (purge) process when switching from sample to zero and from zero to span. This transition time is the time required to purge the existing air. ▲

Depending on the plumbing configuration and the instrument, data from approximately the first minute of a zero calibration or check should be disregarded because of residual sample air. Also, data from approximately the first minute of a span calibration or check should be disregarded because the span is mixing with the residual zero air. ▲

1. Allow the instrument to warm up and stabilize.
2. Be sure the ozonator is ON. If the ozonator is not ON:
 - a. Press  to display the Main Menu, then choose Instrument Controls > **Ozonator**.
 - b. Press  to toggle the ozonator ON.
 - c. Press  to return to the Run screen.

3. Be sure the instrument is in the auto mode, that is, NO, NO₂, and NO_x measurements are being displayed on the front panel display. If the instrument is not in auto mode:
 - a. Press  to display the Main Menu, then choose Instrument Controls > **Auto/Manual Mode**.
 - b. Select **NO/NO_x**, and press .
 - c. Press  to return to the Run screen.
4. Select the RANGE soft key if available or locate this function in the menu to display the Range screen.
5. Select NO range, and push the AVG soft key to display the Averaging Time screen. It is recommended that a higher averaging time be used for best results. For more information about the ranges or averaging time, see the “Operation” chapter.

Note The averaging time should be less than the zero duration and less than the span duration. ▲

6. Set the calibration pressure to the current reactor pressure.
 - a. Push , choose > Calibration Factors > **Cal Pressure**.
 - b. Use   to increment/decrement the value to match the current reactor pressure, and press  to save the new calibration pressure value.
7. Verify that any filters used during normal monitoring are also used during calibration.
8. Connect the analog/digital outputs to a strip chart recorder(s) or PC(s).

Calibration

Note that with a Model 42*i* High Level equipped with internal zero/span and sample valves, the ZERO and SPAN ports should give identical responses to the sample port when test gases are introduced. The user should calibrate the Model 42*i* High Level using the sample port to introduce the zero and span gas sources. After calibration, the zero and span sources should be plumbed to the appropriate ports on the rear panel of the Model

42i High Level, and then reintroduced to the instrument. The Model 42i High Level should give identical responses to the test gases whether they are introduced via the sample port or the zero or span ports. If not, the plumbing and/or valves should be serviced.

The following procedure discusses calibration of the Model 42i High Level analyzer using the gas phase titrator and zero gas generator previously described. It is suggested that a calibration curve have at least seven points between the zero and full scale NO concentrations. Although the seven-point curve is optional, two of whatever number of points is chosen should be located at the zero and 90% levels and the remaining points equally spaced between these values.

Connecting the GPT Apparatus

Use the following procedure to connect the GPT apparatus.

1. Assemble a dynamic calibration system such as the one shown in Figure 4-1.

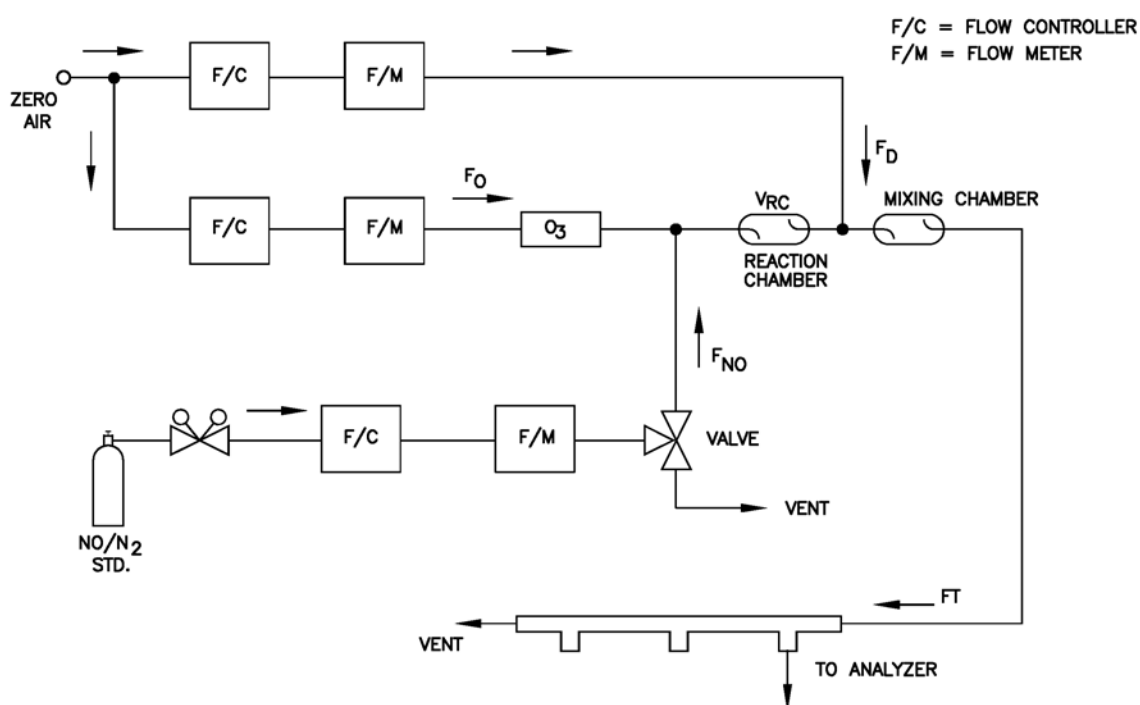

Figure 4-1. GPT System

2. Ensure that all flowmeters are calibrated under the conditions of use against a reliable standard, such as a soap-bubble meter or wet-test

meter. All volumetric flow rates should be corrected to 25 °C and 760 mm Hg.

3. Precautions should be taken to remove O₂ and other contaminants from the NO pressure regulator and delivery system prior to the start of calibration to avoid any conversion of NO to NO₂. Failure to do so can cause significant errors in calibration. This problem can be minimized by:
 - a. carefully evacuating the regulator after the regulator has been connected to the cylinder and before opening the cylinder valve;
 - b. thoroughly flushing the regulator and delivery system with NO after opening the cylinder valve;
 - c. not removing the regulator from the cylinder between calibrations unless absolutely necessary.
4. Connect the analyzer sample bulkhead input to the output of the GPT system.

Dynamic Parameter Specifications for Gas Phase Titrator

Use the following definitions for the remainder of this chapter.

P_R =	Dynamic parameter specification to ensure complete reaction of the available O ₃ , ppm-min
$[NO]_{RC}$ =	NO concentration in the reaction chamber, ppm
t_R =	Residence time of the reactant gases in the reaction chamber, min
$[NO]_{STD}$ =	Concentration of the undiluted NO standard, ppm
F_{NO} =	NO flow rate, sccm
F_O =	O ₃ generator air flow rate, sccm
V_{RC} =	Volume of the reaction chamber, cc
F_T =	Analyzer demand plus 10 to 50% excess

The O₃ generator (ozonator) airflow rate and the NO flow rate must be adjusted such that the following relationships hold:

$$P_R = [\text{NO}]_{\text{RC}} \times t_R \geq 2.75 \text{ ppm} \cdot \text{min}$$

$$[\text{NO}]_{\text{RC}} = [\text{NO}]_{\text{STD}} \frac{F_{\text{NO}}}{(F_{\text{O}} + F_{\text{NO}})}$$

$$t_R = \frac{V_{\text{RC}}}{F_{\text{O}} + F_{\text{NO}}} < 2 \text{ min}$$

Determining GPT System Flow Conditions

Use the following procedure to determine the flow conditions to be used in the GPT system.

1. Determine F_T , the total flow required at the output manifold, which should be equal to the analyzer demand plus 10 to 50 percent excess.
2. Establish $[\text{NO}]_{\text{OUT}}$ as the highest NO concentration that will be required at the output manifold. $[\text{NO}]_{\text{OUT}}$ should be about equal to 90% of the upper range limit (URL) of the NO₂ concentration range to be covered.
3. Determine F_{NO} as:

$$F_{\text{NO}} = \frac{[\text{NO}]_{\text{OUT}} \times F_T}{[\text{NO}]_{\text{STD}}}$$

4. Select a convenient or available reaction chamber volume. Initially a trial volume may be selected in the range of 200 to 500 cc.
5. Compute F_{O} as:

$$F_{\text{O}} = \sqrt{\frac{[\text{NO}]_{\text{STD}} \times F_{\text{NO}} \times V_{\text{RC}}}{2.75}} - F_{\text{NO}}$$

6. Compute t_R as:

$$t_R = \frac{V_{RC}}{F_O + F_{NO}}$$

7. Verify that $t_R < 2$ minutes. If not, select a reaction chamber with a smaller V_{RC} .

8. Compute the diluent air flow rate as:

$$F_D = F_T - F_O - F_{NO}$$

9. If F_O turns out to be impractical for the desired system, select a reaction chamber having a different V_{RC} and re-compute F_D and F_O .

Adjusting Instrument Gain

Use the following procedure to adjust the instrument gain.

Note The NO channel should be calibrated first and then calibrate the NO_x channel. ▲

For detailed information about the menu parameters and the icons used in these procedures, see the “Operation” chapter.

1. Determine the GPT flow conditions required to meet the dynamic parameter specifications as indicated in “Dynamic Parameter Specifications for Gas Phase Titrator” earlier in this chapter.
2. Adjust the GPT diluent air and O₃ generator air flows to obtain the flows determined in “Dynamic Parameter Specifications for Gas Phase Titrator” earlier in this chapter. The total GPT airflow must exceed the total demand of the analyzer. The Model 42i High Level requires approximately 700 cc/min of sample flow, and a total GPT airflow of at least 1.5 liters/min is recommended.
 - a. Allow the analyzer to sample zero air until the NO, NO_x and NO₂ responses stabilize.
 - b. After the responses have stabilized, from the Main Menu, choose Calibration > **Cal NO Background**.
 - c. Press  to set the NO reading to zero.





- d. Press  to return to the Calibration menu and repeat this procedure to set the NO_x background to zero.
 - e. Record the stable zero air responses as Z_{NO}, Z_{NO_x}, and Z_{NO₂} (recorder response, percent scale).
3. Adjust the NO flow from the standard NO cylinder to generate a NO concentration of about 80% of the upper range limit (URL) of the NO range. The exact NO concentration is calculated from:

$$[\text{NO}]_{\text{OUT}} = \frac{F_{\text{NO}} \times \text{NO}_{\text{STD}}}{F_{\text{NO}} + F_{\text{O}} + F_{\text{D}}}$$

Where:

- [NO]_{OUT} = Diluted NO concentration at the output manifold, ppm
 - NO_{STD} = No feed concentration
 - F_{NO} = No flow
 - F_O = Ozone flow
 - F_D = Dilution flow
4. Allow the analyzer to sample the NO calibration gas until the NO, NO₂ and NO_x readings stabilize.
 5. When the responses stabilize, from the Main Menu, choose Calibration > **Cal NO Coefficient**.

The NO line of the Calibrate NO screen displays the current NO concentration. The SPAN CONC line of the display is where you enter the NO calibration gas concentration.

Use  and  to move the cursor left and right and use  and  to increment and decrement each digit.

6. Press  to calculate and save the new NO coefficient based on the entered span concentration.

The NO recorder response will equal:

$$\text{Recorder Response (\% scale)} = \frac{[\text{NO}]_{\text{OUT}}}{\text{URL}} \times 100 + Z_{\text{NO}}$$





Where:

URL = Nominal upper range limit of the NO channel, ppm

Record the $[\text{NO}]_{\text{OUT}}$ concentration and the NO response as indicated by the recorder response.

7. Press  to return to the Calibration menu, and choose **Cal NO_x Coefficient**.
8. Verify that the NO_x calibration gas concentration is the same as the NO calibration gas concentration plus any known NO₂ impurity.

The NO_x line of the Calibrate NO_x screen displays the current NO_x concentration. The SPAN CONC line of the display is where you enter the NO_x calibration gas concentration.

Use  and  to move the cursor left and right and use  and  to increment and decrement each digit. Press  to calibrate the NO_x channel to the NO_x calibration gas.

9. Press  to return to the Run screen. The exact NO_x concentration is calculated from:

$$[\text{NO}_x]_{\text{OUT}} = \frac{F_{\text{NO}} \times ([\text{NO}]_{\text{STD}} + [\text{NO}_2]_{\text{IMP}})}{F_{\text{NO}} + F_{\text{O}} + F_{\text{D}}}$$

Where:

$[\text{NO}_x]_{\text{OUT}}$ = diluted NO_x concentration at the output manifold, ppm

$[\text{NO}_2]_{\text{IMP}}$ = concentration of NO₂ impurity in the standard NO cylinder, ppm

The NO_x recorder response will equal:

$$\text{Recorder Response (\% scale)} = \frac{[\text{NO}_x]_{\text{OUT}}}{\text{URL}} \times 100 + Z_{\text{NO}_x}$$

Where:

URL = Nominal upper range limit of the NO_x channel, ppm

Record the NO_x concentration and the analyzer's NO_x response.

Preparing NO, NO_x, and NO₂ Calibration Curves

Use the following procedure to prepare the NO, NO_x, and NO₂ calibration curves.





1. Generate several additional NO and NO_x concentrations by decreasing F_{NO} or increasing F_D.
2. For each concentration generated, calculate the exact NO and NO_x concentrations using the above equations for [NO]_{OUT} and [NO_x]_{OUT}.
3. Record the NO and NO_x responses.
4. Plot the analyzer responses versus the respective calculated NO and NO_x concentrations and draw or calculate the respective calibration curves. For subsequent calibrations where linearity can be assumed, these curves may be checked with a three-point calibration consisting of a zero point, NO and NO_x concentrations of approximately 80% of the URL, and an intermediate concentration
5. Adjust the GPT system to generate a NO concentration near 90% of the URL of the instrument range selected.
6. Sample this NO concentration until the NO and NO_x responses have stabilized, then measure and record the NO concentration as [NO]_{ORIG}.
7. Adjust the O₃ generator in the GPT system to generate sufficient O₃ to produce a decrease in the NO concentration equivalent to about 80% of the URL of the NO₂ range. The decrease must not exceed 90% of the NO concentration determined in Steps 5 and 6 above.

8. When the analyzer responses stabilize, record the resultant NO concentrations as $[\text{NO}]_{\text{REM}}$.

9. From the Main Menu choose Calibration > **Cal NO₂ Coefficient**.

The NO₂ line of the Calibrate NO₂ screen displays the current NO₂ concentration. The SPAN CONC line of the display is where you enter the NO₂ calibration gas concentration.

10. Set the NO₂ calibration gas concentration to reflect the sum of the following: the NO₂ concentration generated by GPT, ($[\text{NO}]_{\text{ORIG}} - [\text{NO}]_{\text{REM}}$), and any NO₂ impurity.

Use   to move the cursor left and right and use   to increment and decrement the numeric character at the cursor.

$$[\text{NO}_2]_{\text{OUT}} = ([\text{NO}]_{\text{ORIG}} - [\text{NO}]_{\text{REM}}) + \frac{F_{\text{NO}} \times [\text{NO}_2]_{\text{IMP}}}{F_{\text{NO}} + F_{\text{O}} + F_{\text{D}}}$$

Where:

$[\text{NO}_2]_{\text{OUT}}$ = diluted NO₂ concentration at the output manifold, ppm

$[\text{NO}]_{\text{ORIG}}$ = original NO concentration, prior to addition of O₃, ppm

$[\text{NO}]_{\text{REM}}$ = NO concentration remaining after addition of O₃, ppm

11. Press  to calculate and save the new NO₂ coefficient based on the entered span concentration.

The analyzer does a one point NO₂ span coefficient calculation, corrects the NO₂ reading for converter inefficiency, and then adds the corrected NO₂ to the NO signal to give a corrected NO_x signal.

If the analyzer calculates a NO₂ span coefficient of less than 0.96, either the entered NO₂ concentration is incorrect, the converter is not being heated to the proper temperature, the instrument needs servicing (leak or imbalance), or the converter needs replacement or servicing. The NO₂ analog output will reflect the NO₂ concentration generated by GPT, any NO₂ impurity, and the NO₂ zero offset.

The recorder response will be as follows:

$$\text{Recorder Response (\% scale)} = \frac{[\text{NO}_2]_{\text{OUT}}}{\text{URL}} \times 100 + Z_{\text{NO}_2}$$

Where:

URL = Nominal upper range limit of the NO₂ channel, ppm

12. Record the NO₂ concentration and the analyzer's NO₂ response.
13. Maintaining the same F_{NO}, F_O, and F_D, adjust the ozone generator to obtain several other concentrations of NO₂ over the NO₂ range (at least five evenly spaced points across the remaining scale are suggested).
14. Record the stable responses and plot the analyzer's NO₂ responses versus the corresponding calculated (using the above equation for [NO₂]_{OUT}) concentrations and draw or calculate the NO₂ calibration curve.

Note It is important that the curve should be linear within ±1% FS over the NO₂ range. If the curve is nonlinear, the analyzer is not operating correctly (possible leak, or converter failure, etc.) and should be serviced. Assuming the curve is linear, subsequent data should be reduced using this NO₂ calibration curve response. ▲

Using the Calibration Factors menu can change the calibration factors. This is often useful in a troubleshooting situation. However, after the above calibration procedure is completed, all subsequent data reduction depends on the calibration parameters, remaining the same as during the initial calibration. ▲

Therefore never change any calibration factor without first recording the value so that after any troubleshooting procedure is completed, the initial value can be re-entered thereby not altering the multipoint calibration. ▲

Calibration in Dual Range and Auto Range Mode

The dual/auto range calibration feature is used to calibrate the analyzer at two different span levels (as opposed to a single span level in the standard mode) generating a “tailored multi-point” calibration curve stored in the analyzer's memory. This feature may be used:

Calibration

Calibration in Dual Range and Auto Range Mode



- When widely different gas levels are being monitored, such as a factor of 10 or greater apart
- If precision and span levels are being introduced using separate tanks
- If more than one multi-component cylinder is being used to calibrate the instrument

Properly designed chemiluminescence analyzers are inherently linear over a wide dynamic range; and under normal USEPA compliance situations this feature is not required. Dual calibration may be used for span levels less than a factor of 10 apart, however if this is done to correct for a significant non-linearity, it may mask the problems causing the effect, such as, bad calibration cylinder, leaks in sampling lines, or low ozonator output.

Use the following procedures to calibrate the analyzer in dual or auto range mode.

Use the following procedure to set NO and NO_x background readings to zero. Both the Set NO Background and Set NO_x Background screens operate the same way, and the following procedure also applies to the Set NO_x background screen.

For detailed information about the menu parameters and the icons used in these procedures, see the “Operation” chapter.

1. Follow the “Pre-Calibration” procedure described previously in this chapter.
2. Introduce zero air to the SAMPLE bulkhead and allow the analyzer to sample zero air until the NO, NO_x, and NO₂ responses stabilize.
3. When the responses stabilize, from the Main Menu choose Calibration > **Cal NO Background**.
4. The Set NO Background screen displays the current NO background and NO concentration.
5. Press  to set the NO background to zero.
6. Press  to return to the Run screen.





7. Repeat Steps 3 through 6, selecting **Cal NO_x Background** to set the NO_x background to zero.

Calibrate Low NO

Use the following procedure to calibrate NO channel to the NO calibration gas.

1. Disconnect the source of zero air from the SAMPLE bulkhead. In its place, connect a source of NO calibration gas of about 80% of the low NO full-scale range.
2. Allow the analyzer to sample the low NO calibration gas until the NO, NO₂, and NO_x readings stabilize.
3. When the responses are stable, from the Main Menu choose Calibration > **Cal Lo NO Coefficient**.
4. The Lo NO field displays the current NO concentration.

The Lo Span Conc field is where you enter the low NO calibration gas concentration.

Use   to move the cursor left and right and use   to increment and decrement the numeric character at the cursor.

5. Press  to calculate and save the new low NO coefficient based on the entered span concentration.

Calibrate Low NO_x





Use the following procedure to calibrate the NO_x channel to the NO_x calibration gas.



1. Press  to return to the Calibration menu and choose **Cal Lo NO_x Coefficient**.
2. Verify that the low NO_x calibration gas concentration is the same as the low NO calibration gas concentration plus any known NO₂ impurity.

The Lo NO_x field displays the current NO_x concentration. The Lo Span Conc field is where you enter the low NO_x calibration gas concentration.

Calibration

Calibration in Dual Range and Auto Range Mode

Use   to move the cursor left and right and use 
 to increment and decrement the numeric character at the cursor.

3. Press  to calculate and save the new low NO_x coefficient based on the entered span concentration.
4. Press  to return to the Run screen.





Calibrate Low NO₂

Use the following procedure to calibrate the NO₂ channel to the NO₂ calibration gas.

1. Adjust the O₃ generator in the GPT system to generate sufficient O₃ to produce a decrease in the low NO concentration equivalent to about 80% of the URL of the low NO₂ range. The decrease must not exceed 90% of the low NO concentration determined in the “Calibrate Low NO_x” procedure.
2. From the Main Menu choose Calibration > **Cal Lo NO₂ Coefficient**.

The Lo NO₂ field displays the current NO₂ concentration. The Lo Span Conc field is where you enter the Lo NO₂ calibration gas concentration.

3. Set the low NO₂ calibration gas concentration to reflect the sum of the NO₂ concentration generated by GPT and any NO₂ impurity.

Use   to move the cursor left and right and use 
 to increment and decrement the numeric character at the cursor.

4. Press  to calculate and save the new low NO₂ coefficient based on the entered span concentration.





Calibrate High NO

Use the following procedure to calibrate the NO channel to the NO calibration gas.

1. Connect a source of high NO calibration gas of about 80% of the high NO full-scale range. Allow the analyzer to sample the high NO calibration gas until the NO, NO₂, and NO_x readings have stabilized.

2. After the responses have stabilized, from the Main Menu, choose Calibration > **Cal Hi NO Coefficient**.

The Hi NO field displays the current NO concentration. The Hi Span Conc field is where you enter the high NO calibration gas concentration.





Use   to move the cursor left and right and use   to increment and decrement the numeric character at the cursor.



3. Press  to calculate and save the new high NO coefficient based on the entered span concentration.

Calibrate High NO_x

Use the following procedure to calibrate the NO_x channel to the NO_x calibration gas.

1. Press  to return to the Calibration menu, and choose **Cal Hi NO_x Coefficient**.
2. Verify that the high NO_x calibration gas concentration is the same as the high NO calibration gas concentration plus any known NO₂ impurity.

Use   to move the cursor left and right and use   to increment and decrement the numeric character at the cursor.

3. Press  to calculate and save the new high NO_x coefficient based on the entered span concentration.
4. Press  to return to the Run screen.

Calibrate High NO₂





Use the following procedure to calibrate the NO₂ channel to the NO₂ calibration gas.

1. Adjust the O₃ generator in the GPT system to generate sufficient O₃ to produce a decrease in the high NO concentration equivalent to about 80% of the URL of the high NO₂ range. The decrease must not exceed 90% of the high NO concentration determined in the “Calibrate High NO_x” procedure.

- From the Main Menu, choose Calibration > **Cal Hi NO₂ Coefficient**.

The Hi NO₂ field displays the current NO₂ concentration. The Hi Span Conc field is where you enter the high NO₂ calibration gas concentration.

- Set the high NO₂ calibration gas concentration to reflect the sum of the NO₂ concentration generated by GPT and any NO₂ impurity.

Use   to move the cursor left and right and use   to increment and decrement the numeric character at the cursor.

- Press  to calculate and save the new high NO₂ coefficient based on the entered span concentration.

You can change the calibration factors by using the Calibration Factors menu. This is often useful in a troubleshooting situation. However, after the above calibration procedure is completed, all subsequent data reduction depends on the calibration parameters remaining the same as during the initial calibration.

Therefore never change any calibration factor without first recording the value so that after any troubleshooting procedure is completed, the initial value can be re-entered thereby not altering the multipoint calibration.

Zero and Span Check

The analyzer requires initial and periodic calibration according to the procedures outlined in this manual. Initially, the frequency of the calibration procedure should be determined by the stability of the zero and span checks, which may be run daily. You should generate a new calibration curve when zero and span checks indicate a shift in instrument gain of more than 10 percent from that determined during the most recent multipoint calibration. You can adjust the frequency of calibration and even zero and span checks appropriately as you gain confidence with the instrument.

You should have a quality control plan where the frequency and the number of points required for calibration can be modified on the basis of calibration and zero and span check data collected over a period of time. Note however, that the EPA requires a minimum of one multipoint calibration per calendar quarter. Such a quality control program is essential to ascertain the accuracy and reliability of the air quality data collected and to alert the user if the accuracy or reliability of the data should become unacceptable. A compilation of this kind might include items such as dates of calibration, atmospheric conditions, calibration factors, and other pertinent data.

Use the following procedure to perform a zero and span check.

1. Connect the zero gas to the SAMPLE bulkhead in a standard instrument or to the ZERO bulkhead in a Model 42i High Level equipped with the zero/span and sample solenoid valve option.
2. Allow the instrument to sample zero gas until a stable reading is obtained on the NO, NO₂, and NO_x channels then record the zero readings. Unless the zero has changed by more than ±0.010 ppm, it is recommended that the zero not be adjusted. If an adjustment larger than this is indicated due to a change in zero reading, a new multipoint calibration curve should be generated.
3. Attach a supply of known concentration of NO and NO₂ (usually generated via an NIST traceable NO working standard and a GPT system) to the SAMPLE bulkhead (or SPAN bulkhead for instruments equipped with the zero/span and sample solenoid valve option) on the rear panel.
4. Allow the instrument to sample the calibration gas until a stable reading is obtained on the NO, NO₂, and NO_x channels. If the calibration has changed by more than ±10%, a new multipoint calibration curve should be generated.
5. When the calibration check has been completed, record the NO, NO₂, and NO_x values.
6. Reconnect the analyzer sample line to the SAMPLE bulkhead.

Calibration

Zero and Span Check

Chapter 5 Preventive Maintenance

This chapter describes the periodic maintenance procedures that should be performed on the instrument to ensure proper operation. Since usage and environmental conditions vary greatly, you should inspect the components frequently until an appropriate maintenance schedule is determined.

This chapter includes the following maintenance information and replacement procedures:

- “Safety Precautions” on page 5-1
- “Cleaning the Outside Case” on page 5-2
- “Ozonator Air Feed Drying Column Replacement” on page 5-2
- “Capillaries Inspection and Replacement” on page 5-2
- “Thermoelectric Cooler Fins Inspection and Cleaning” on page 5-4
- “Fan Filters Inspection and Cleaning” on page 5-4
- “Pump Rebuilding” on page 5-5

Safety Precautions

Read the safety precautions before beginning any procedures in this chapter.



WARNING If the equipment is operated in a manner not specified by the manufacturer, the protection provided by the equipment may be impaired. ▲



Equipment Damage Some internal components can be damaged by small amounts of static electricity. A properly grounded antistatic wrist strap must be worn while handling any internal component. For more information about appropriate safety precautions, see the “Servicing” chapter. ▲

Replacement Parts

See the “Servicing” chapter for a list of replacement parts.

Cleaning the Outside Case

Clean the outside case using a damp cloth being careful not to damage the labels on the case.



Equipment Damage Do Not use solvents or other cleaning products to clean the outside case.

Ozonator Air Feed Drying Column Replacement

Use the following procedure to replace the ozonator air feed drying column.

1. Remove the drying column from the connector DRY AIR bulkhead on the rear panel of the instrument.
2. Replace spent absorbent material (indicating Drierite or silica gel) with regenerated material.
3. Reinstall the drying column to the DRY AIR bulkhead.
4. Perform a Zero/Span check (see the “Calibration” chapter).

Capillaries Inspection and Replacement

The capillaries normally only require inspection when instrument performance indicates that there may be a flow problem.



Equipment Damage Some internal components can be damaged by small amounts of static electricity. A properly grounded antistatic wrist strap must be worn while handling any internal component. For more information about appropriate safety precautions, see the “Servicing” chapter. ▲

Use the following procedure to inspect and replace the capillaries. This procedure can be used to check any or all of the capillaries.

1. Turn the instrument OFF and unplug the power cord.
2. Remove the instrument cover.
3. Locate the capillaries. See [Figure 5-1](#) and [Figure 7-2](#).

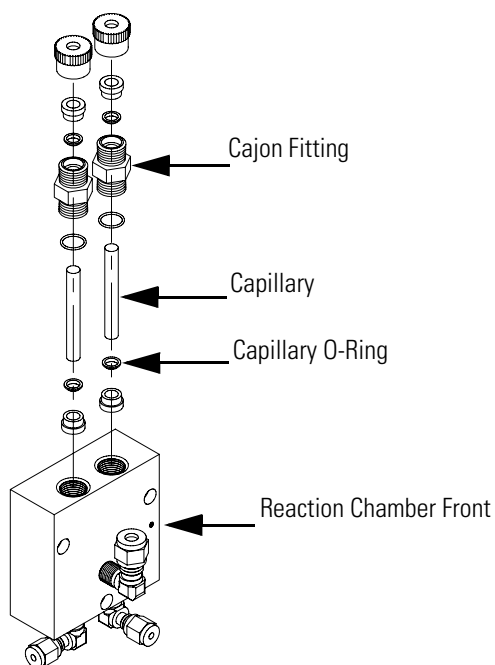

Figure 5-1. Inspecting and Replacing the Capillaries

4. Remove the Cajon® fitting(s) from the reaction chamber body using a 5/8-inch wrench.
5. Remove the glass capillaries and O-ring. Inspect O-ring for cuts or abrasion, and replace as necessary.
6. Check capillary for particulate deposits. Clean or replace as necessary.
7. Replace capillary in reaction chamber body, making sure the O-ring is around the capillary before inserting it into the body.
8. Replace Cajon® fitting. Note that the Cajon® fitting should be replaced only hand tight.
9. Re-install the cover.
10. Connect the power cord and turn the instrument ON.

Thermoelectric Cooler Fins Inspection and Cleaning



Use the following procedure to inspect and clean the thermoelectric cooler fins.

Equipment Damage Some internal components can be damaged by small amounts of static electricity. A properly grounded antistatic wrist strap must be worn while handling any internal component. For more information about appropriate safety precautions, see the “Servicing” chapter. ▲

1. Turn the instrument off and unplug the power cord.
2. Remove the instrument cover.
3. Locate the PMT cooler, refer to [Figure 7-6](#) in the “Servicing” chapter.
4. Blow off the cooler fins using clean pressurized air. It may be more convenient to vacuum the cooler fins. In either case, make sure that any particulate accumulation between the fins has been removed.
5. If necessary, use a small brush to remove residual particulate accumulation.
6. Replace the cover.
7. Connect the power cord and turn the instrument ON.

Fan Filters Inspection and Cleaning

Use the following procedure to inspect and clean the fan filters.

1. Remove the two fan guards from the fans and remove the filters.
2. Flush the filters with warm water and let dry (a clean, oil-free purge will help the drying process) or blow the filters clean with compressed air.
3. Re-install the filters and fan guards.

Pump Rebuilding

Use the following procedure to rebuild the pump (Figure 5-2). To replace the pump, see “Pump Replacement” in the “Servicing” chapter.



Equipment Damage Some internal components can be damaged by small amounts of static electricity. A properly grounded antistatic wrist strap must be worn while handling any internal component. For more information about appropriate safety precautions, see the “Servicing” chapter. ▲

Equipment Required:

Pump repair kits (two repair kits required per pump)

Allen wrench, 3 mm and 4 mm

Wrench, 9/16-inch

Needlenose pliers

1. Turn instrument off, unplug the pump power cord, and disconnect the pump plumbing from the instrument.
2. Note the orientation of the pump head top plate for later reassembly. Using a 3 mm Allen wrench, remove the eight socket head screws and washers securing the pump head top plate.
3. Discard the old Teflon⁷ gasket.
4. Note the orientation of the diaphragm head for later reassembly. Remove the diaphragm head. Using a 4 mm Allen wrench, remove the four socket head screws securing the diaphragm head to the pump body.
5. Insert the tips of blunt needlenose pliers in the dimples of the clamping disk, then loosen and remove the clamping disk.
6. Remove and discard the old Teflon⁷ diaphragm.
7. Insert the clamping disk into the new Teflon⁷ diaphragm (three pieces) and screw the clamping disk into the pump. Do not over tighten.

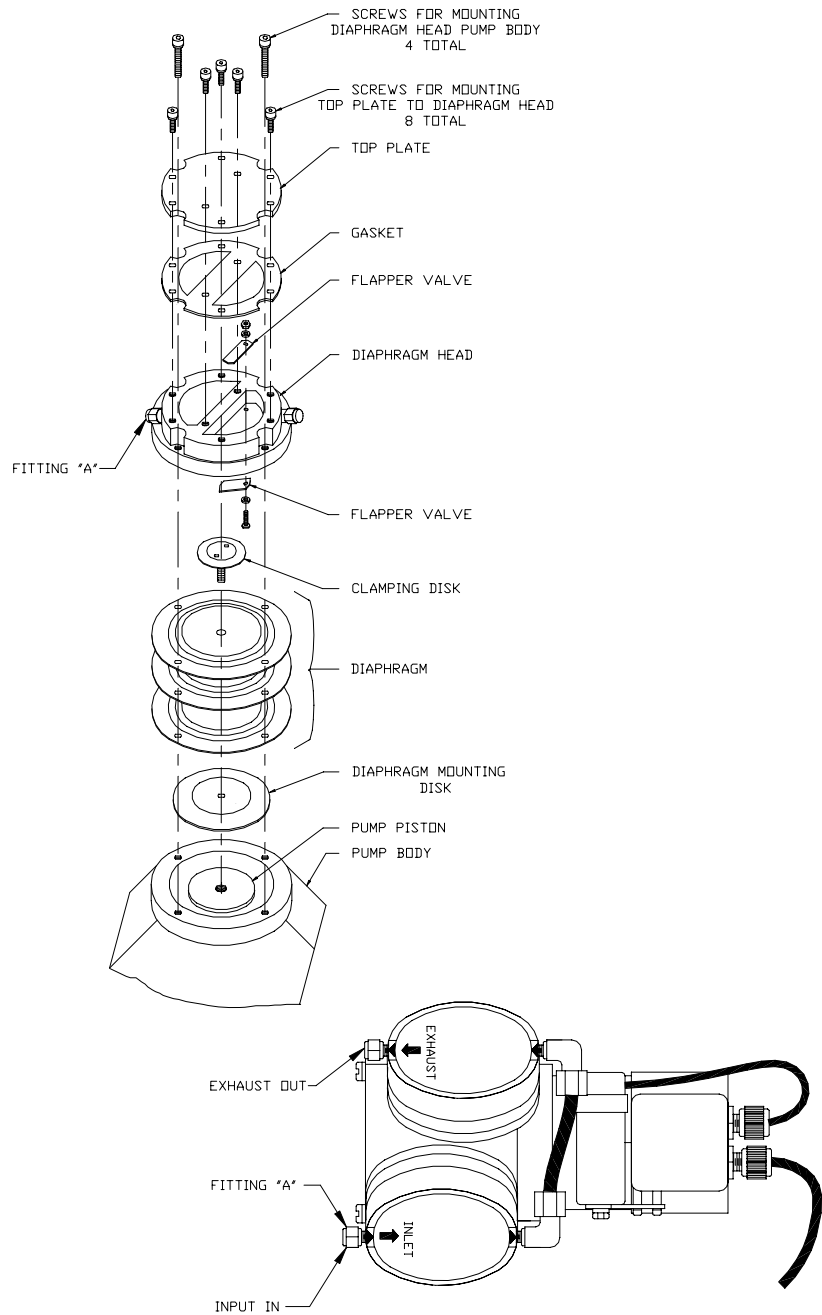

Figure 5-2. Rebuilding the Pump

8. Remove the screw and nut securing the flapper valves and remove and discard old flapper valves.

9. Install the new flapper: check that the screw head and not the washer is on the smooth side of the pump, and check that the flappers are completely flat and straight.
10. Align the diaphragm head correctly as noted in Step 2, and secure with the four socket head screws.
11. Place the new Teflon⁷ gasket over the pump head so that the eight screws holes are aligned.
12. Replace the top plate and secure with the eight screws and washers being sure that the Teflon⁷ gasket stays in place.
13. Reconnect the plumbing to the instrument and plug in the pump power cord.

Preventive Maintenance

Pump Rebuilding

Chapter 6 Troubleshooting

This instrument has been designed to achieve a high level of reliability. In the event of problems or failure, the troubleshooting guidelines, board-level connection diagrams, connector pin descriptions, and testing procedures presented in this chapter should be helpful in isolating and identifying problems.

For additional fault location information refer to the “Preventive Maintenance” chapter in this manual.

The service mode in the “Operation” chapter includes parameters and functions that are useful when making adjustments or diagnosing problems. The service mode includes some of the same information found in the Diagnostic menu, however, readings are updated every second in the service mode compared with every 10 seconds in the Diagnostics menu.

The Technical Support Department at Thermo Fisher Scientific can also be consulted in the event of problems. See “Service Locations” at the end of this chapter for contact information. In any correspondence with the factory, please note both the serial number and program number of the instrument.

This chapter provides the following troubleshooting and service support information:

- “Safety Precautions” on page 6-1
- “Troubleshooting Guides” on page 6-2
- “Board-Level Connection Diagrams” on page 6-6
- “Connector Pin Descriptions” on page 6-8
- “Service Locations” on page 6-22

Safety Precautions

Read the safety precautions in the Preface and the “Servicing” chapter before performing any actions listed in this chapter.

Troubleshooting Guides

The troubleshooting guides presented in this chapter are designed to help isolate and identify instrument problems.

[Table 6-1](#) provides general troubleshooting information and indicates the checks that you should perform if you experience an instrument problem.

[Table 6-2](#) lists all the alarm messages you may see on the graphics display and provides recommendations about how to resolve the alarm condition.

Table 6-1. Troubleshooting - General Guide

Malfunction	Possible Cause	Action
Does not start up	No power	Check that the instrument is plugged into the proper source (115 or 220 VAC, 50 or 60Hz). Check instrument fuses.
	Power supply	Check voltages using a digital voltmeter.
	Digital electronics	Unplug power cord. Check that all boards are seated properly. Unplug power cord. Remove one board. Install known good board. Repeat until faulty board is detected.
No output signal (or very low output)	No sample gas reaching the analyzer	Check input sample flow.
	Blocked sample capillary	Unplug power cord. Clean or replace capillary.
	No ozone reaching the reaction chamber	Check the Instrument Control menu to see if the ozonator is ON. If it is ON, check dry air supply.
No output signal	Disconnected or defective input or high voltage supply	Unplug power cord. Check that cables are connected properly. Check cable resistance.
	Analyzer not calibrated	Recalibrate.
	Defective ± 15 volt	Check supply voltages (Diagnostics Menu).
Calibration drift	Dryer to ozonator depleted	Replace.
	Line voltage fluctuations	Check to see if line voltage is within specifications.
	Defective pump	Rebuild pump.

Table 6-1. Troubleshooting - General Guide, continued

Malfunction	Possible Cause	Action
	Unstable NO or NO ₂ source	Replace.
	Clogged capillaries	Unplug power cord. Clean or replace capillary.
	Clogged sample air filter	Replace filter element.
Excessive noise	Defective or low sensitivity PMT	Unplug power cord. Remove PMT. Install known good PMT. Plug in power cord. Check performance.
	Defective input board	Replace board.
	Defective cooler	Check temperature (less than -2 °C at T _{amb} = 25 °C).
Non-linear response	Incorrect calibration source	Verify accuracy of multipoint calibration source gas.
	Leak in sample probe line	Check for variable dilution.
Excessive response time	Partially blocked sample capillary	Unplug power cord. Clean or replace capillary.
	Hang up/blockage in sample filter	Change element.
Improper converter operation	Questionable calibration gas	Verify accuracy.
	Converter temperature too high or too low	Temperature should be approximately 325 °C.
	Low line voltage	Check to see if line voltage is within specifications.
	Molybdenum consumed	Replace Molybdenum converter cartridge.

Table 6-2. Troubleshooting - Alarm Messages

Alarm Message	Possible Cause	Action
Alarm - Cooler Temp High	Check fan operation	Replace defective fan.
	Check fan filter	Clean or replace foam filter.
Cooler reads 80 °C	Bad unit	Replace cooler.
	Cooler does not hold set point of -3 °C	Replace cooler – thermoelectric module inside cooler failed.

Table 6-2. Troubleshooting - Alarm Messages, continued

Alarm Message	Possible Cause	Action
	Cooler reads -20 °C	Replace cooler – thermocouple bad.
Alarm - Internal Temp	Check fan operation	Replace fan if not operating properly.
	Check fan filter	Clean or replace foam filter, refer to "Preventive Maintenance" chapter in this manual.
Alarm - Chamber Temp	Chamber temperature below set point of 50 °C	Check 10K thermistor, replace if bad. Check temperature control board to insure the LEDs are coming on. If not, temperature control board could be defective.
Alarm - Conv. Temp	Converter temperature low	Molybdenum converter should be hot to the touch, if not the heater may have failed. Check that converter temp. set point is approximately 325 °C. Check that voltage to the heater is 115 VAC.
Alarm - Pressure	High pressure indication	Check the pump for a tear in the diaphragm, replace with pump repair kit if necessary. Refer to "Preventive Maintenance" chapter in this manual. Check that capillaries are properly installed and O-rings are in good shape. Replace if necessary. Check flow system for leaks.
Alarm - Sample flow	Sample flow "Low"	Check sample capillary (.015 inch ID) for blockage. Replace as necessary. If using sample particulate filter make sure it is not blocked. Disconnect sample particulate filter from the sample bulkhead, if flow increases, replace the filter.

Table 6-2. Troubleshooting - Alarm Messages, continued

Alarm Message	Possible Cause	Action
Alarm - Ozonator Flow	Ozone flow low	Check ozone capillary (.008 inch ID) for blockage. Replace as necessary.
Alarm - NO, NO ₂ , NO _x Conc.	Concentration has exceeded range limit	Check to insure range corresponds with expected value. If not select proper range.
	Concentration low	Check user-defined low set point, set to zero.

Board-Level Connection Diagrams

Figure 6-1 and Figure 6-2 are board-level connection diagrams for the common electronics and measurement system. These illustrations can be used along with the connector pin descriptions in Table 6-3 through Table 6-9 to troubleshoot board-level faults.

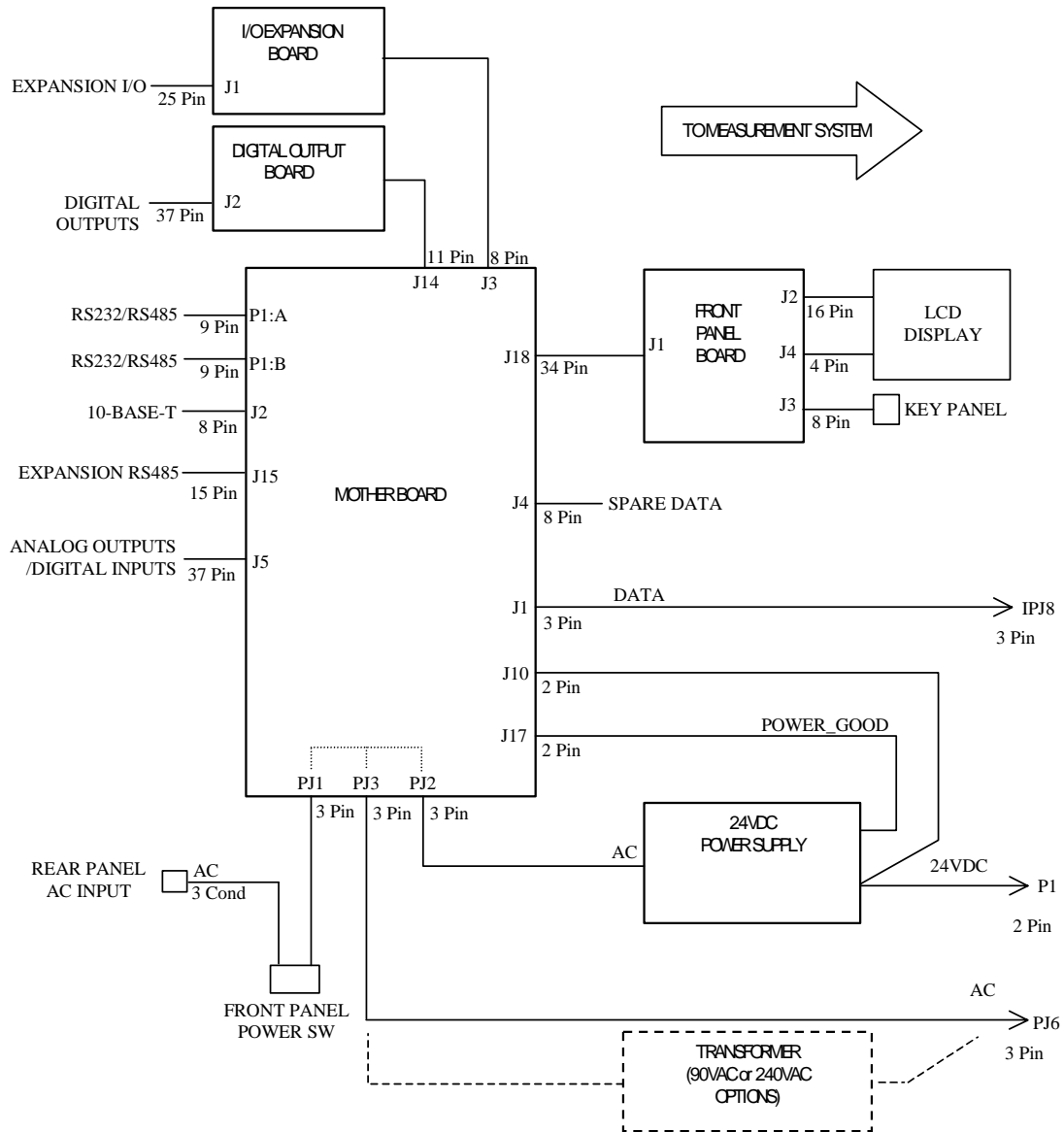

Figure 6-1. Board-Level Connection Diagram - Common Electronics

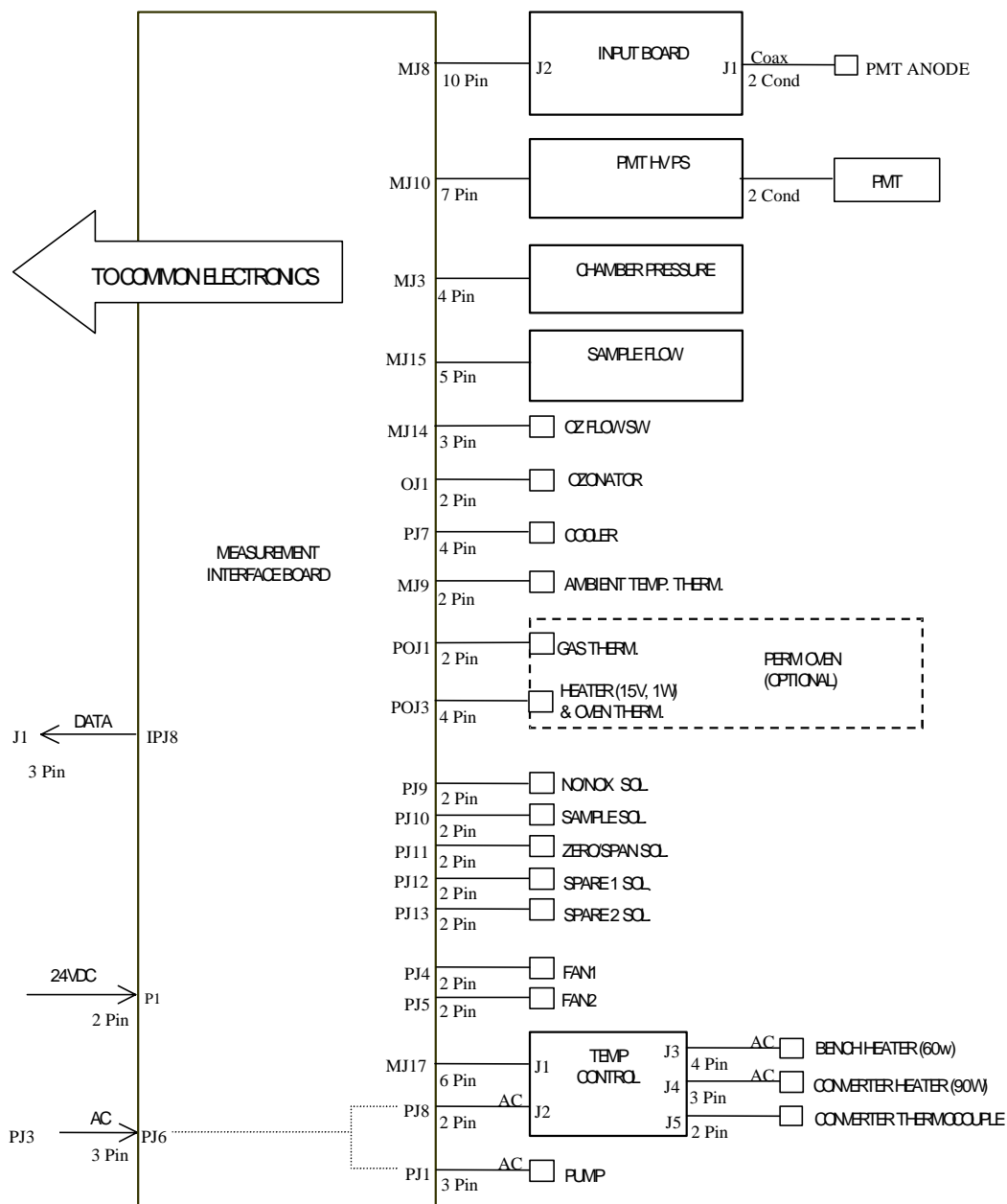

Figure 6-2. Board-Level Connection Diagram - Measurement System

Connector Pin Descriptions

The connector pin descriptions in [Table 6-3](#) through [Table 6-9](#) can be used along with the board-level connection diagrams to troubleshoot board-level faults.

Table 6-3. Motherboard Connector Pin Descriptions

Connector Label	Reference Designator	Pin	Signal Descriptions
INTF DATA	J1	1	Ground
		2	+RS485 to Interface Board
		3	-RS485 to Interface Board
10-BASE-T	J2	1	Ethernet Output (+)
		2	Ethernet Output (-)
		3	Ethernet Input (+)
		4	NC
		5	NC
		6	Ethernet Input (-)
		7	NC
		8	NC
INTF DATA	J1	1	Ground
		2	+RS485 to Interface Board
		3	-RS485 to Interface Board
10-BASE-T	J2	1	Ethernet Output (+)
		2	Ethernet Output (-)
		3	Ethernet Input (+)
		4	NC
		5	NC
		6	Ethernet Input (-)
		7	NC
		8	NC
EXPANSION BD	J3	1	+5V
		2	+24V
		3	+24V
		4	Ground
		5	Ground
		6	Ground
		7	+RS485 to Expansion Board
		8	-RS485 to Expansion Board

Table 6-3. Motherboard Connector Pin Descriptions, continued

Connector Label	Reference Designator	Pin	Signal Descriptions
SPARE DATA	J4	1	+5V
		2	+24V
		3	+24V
		4	Ground
		5	Ground
		6	Ground
		7	+RS485 to Spare Board
		8	-RS485 to Spare Board
I/O	J5	1	Power Fail Relay N.C. Contact
		2	Ground
		3	TTL Input 1
		4	TTL Input 2
		5	Ground
		6	TTL Input 5
		7	TTL Input 7
		8	TTL Input 8
		9	TTL Input 10
		10	Ground
		11	TTL Input 13
		12	TTL Input 15
		13	Ground
		14	Analog Voltage Output 1
		15	Analog Voltage Output 3
		16	Ground
		17	Analog Voltage Output 5
		18	Ground
		19	Ground
		20	Power Fail Relay COM
		21	Power Fail Relay N.O. Contact
		22	Ground
		23	TTL Input 3
		24	TTL Input 4
		25	TTL Input 6

Table 6-3. Motherboard Connector Pin Descriptions, continued

Connector Label	Reference Designator	Pin	Signal Descriptions
		26	Ground
		27	TTL Input 9
		28	TTL Input 11
		29	TTL Input 12
		30	TTL Input 14
		31	TTL Input 16
		32	Ground
		33	Analog Voltage Output 2
		34	Analog Voltage Output 4
		35	Ground
		36	Analog Voltage Output 6
		37	Ground
SER EN	J7	1	Serial Enable Jumper
		2	+3.3V
24V IN	J10	1	+24V
		2	Ground
DIGITAL I/O	J14	1	+5V
		2	+24V
		3	+24V
		4	Ground
		5	Ground
		6	Ground
		7	SPI Reset
		8	SPI Input
		9	SPI Output
		10	SPI Board Select
		11	SPI Clock
EXT. RS485	J15	1	-RS485 to Rear Panel
		2	+RS485 to Rear Panel
		3	+5V
		4	+5V
		5	+5V
		6	Ground

Table 6-3. Motherboard Connector Pin Descriptions, continued

Connector Label	Reference Designator	Pin	Signal Descriptions
		7	Ground
		8	Ground
		9	NC
		10	NC
		11	+24V
		12	+24V
		13	+24V
		14	+24V
		15	+24V
24V MONITOR	J17	1	24V Power Monitor
		2	Ground
FRONT PANEL BD	J18	1	Ground
		2	Ground
		3	LCLK – LCD Signal
		4	Ground
		5	Ground
		6	LLP – LCD Signal
		7	LFLM – LCD Signal
		8	LD4 – LCD Signal
		9	LD0 – LCD Signal
		10	LD5 – LCD Signal
		11	LD1 – LCD Signal
		12	LD6 – LCD Signal
		13	LD2 – LCD Signal
		14	LD7 – LCD Signal
		15	LD3 – LCD Signal
		16	LCD Bias Voltage
		17	+5V
		18	Ground
		19	Ground
		20	LCD_ONOFF – LCD Signal
		21	Keypad Row 2 Input

Table 6-3. Motherboard Connector Pin Descriptions, continued

Connector Label	Reference Designator	Pin	Signal Descriptions
		22	Keypad Row 1 Input
		23	Keypad Row 4 Input
		24	Keypad Row 3 Input
		25	Keypad Col 2 Select
		26	Keypad Col 1 Select
		27	Keypad Col 4 Select
		28	Keypad Col 3 Select
		29	Ground
		30	Ground
		31	Ground
		32	Ground
		33	+24V
		34	+24V
RS232/RS485:A	P1:A	1	NC
		2	Serial Port 1 RX (-RS485 IN)
		3	Serial Port 1 TX (-RS485 OUT)
		4	NC
		5	Ground
		6	NC
		7	Serial Port 1 RTS (+RS485 OUT)
		8	Serial Port 1 CTS (+RS485 IN)
		9	NC
RS232/RS485:B	P1:B	1	NC
		2	Serial Port 2 RX (-RS485 IN)
		3	Serial Port 2 TX (-RS485 OUT)
		4	NC
		5	Ground
		6	NC
		7	Serial Port 2 RTS (+RS485 OUT)
		8	Serial Port 2 CTS (+RS485 IN)
		9	NC
AC IN	PJ1	1	AC-HOT
		2	AC-NEUT

Table 6-3. Motherboard Connector Pin Descriptions, continued

Connector Label	Reference Designator	Pin	Signal Descriptions
AC 24VPWR	PJ2	3	AC-Ground
		1	AC-HOT
		2	AC-NEUT
AC INTF BD	PJ3	3	AC-Ground
		1	AC-HOT
		2	AC-NEUT
		3	AC-Ground

Table 6-4. Measurement Interface Board Connector Pin Descriptions

Connector Label	Reference Designator	Pin	Signal Description
DATA	IPJ8	1	Ground
		2	+RS485 from Motherboard
		3	-RS485 from Motherboard
PRES	MJ3	1	Pressure Sensor Input
		2	Ground
		3	+15V
		4	-15V
INPUT BD	MJ8	1	+15V
		2	Ground
		3	-15V
		4	+5V
		5	Ground
		6	Measurement Frequency Output
		7	Amplifier Zero Adjust Voltage
		8	SPI Output
		9	SPI Clock
		10	SPI Board Select
AMB TEMP	MJ9	1	Ambient Temperature Thermistor
		2	Ground
HVPS	MJ10	1	HV Power Supply Voltage Adjust
		2	Ground

Table 6-4. Measurement Interface Board Connector Pin Descriptions, continued

Connector Label	Reference Designator	Pin	Signal Description
		3	HV Power Supply On/Off
		4	Ground
		5	HV Power Supply Voltage Monitor
		6	Ground
		7	Ground
FLOW SW	MJ14	1	NC
		2	Ground
		3	Ozonator Flow OK Switch
FLOW	MJ15	1	Flow Sensor Input
		2	Ground
		3	+15V
		4	-15V
		5	Ground
TEMP CTRL	MJ17	1	Bench Temperature Input
		2	Ground
		3	-15V
		4	Converter Heater On/Off
		5	Converter Temperature Input
		6	+15V_PWR
OZONATOR	OJ1	1	Ozonator Output A
		2	Ozonator Output B
24V IN	P1	1	+24V
		2	Ground
PROV INPUT	P2	1	Spare Voltage Input
		2	Ground
		3	Ground
		4	Ground
		5	Ground
		6	Ground
		7	Spare Frequency Input
		8	Ground
		9	Ground
AC PUMP	PJ1	1	AC-HOT

Table 6-4. Measurement Interface Board Connector Pin Descriptions, continued

Connector Label	Reference Designator	Pin	Signal Description
		2	AC-NEUT
		3	AC-Ground
FAN 1	PJ4	1	+24V
		2	Ground
FAN 2	PJ5	1	+24V
		2	Ground
AC IN	PJ6	1	AC-HOT
		2	AC-NEUT
		3	AC-Ground
COOLER	PJ7	1	Cooler Thermistor
		2	Ground
		3	+15V_PWR
		4	Cooler On/Off Control
AC TEMP	PJ8	1	AC-HOT
		2	AC-NEUT
		3	AC-Ground
NO/NOX SOL.	PJ9	1	+24V
		2	NO/NOX Solenoid Control
SAMPLE SOL.	PJ10	1	+24V
		2	Sample Solenoid Control
Z/S SOL.	PJ11	1	+24V
		2	Zero/Span Solenoid Control
SPARE1 SOL.	PJ12	1	+24V
		2	Spare 1 Solenoid Control
SPARE2 SOL.	PJ13	1	+24V
		2	Spare 2 Solenoid Control
PERM OVEN THERM	POJ1	1	Perm Oven Gas Thermistor
		2	Ground
PERM OVEN	POJ3	1	Perm Oven Heater On/Off
		2	+15V_PWR
		3	Perm Oven Thermistor
		4	Ground

Table 6-5. Front Panel Board Connector Pin Diagram

Connector Label	Reference Designator	Pin	Signal Description
MOTHER BOARD	J1	1	Ground
		2	Ground
		3	LCLK – LCD Signal
		4	Ground
		5	Ground
		6	LLP – LCD Signal
		7	LFLM – LCD Signal
		8	LD4 – LCD Signal
		9	LD0 – LCD Signal
		10	LD5 – LCD Signal
		11	LD1 – LCD Signal
		12	LD6 – LCD Signal
		13	LD2 – LCD Signal
		14	LD7 – LCD Signal
		15	LD3 – LCD Signal
		16	LCD Bias Voltage
		17	+5V
		18	Ground
		19	Ground
		20	LCD_ONOFF – LCD Signal
		21	Keypad Row 2 Input
		22	Keypad Row 1 Input
		23	Keypad Row 4 Input
		24	Keypad Row 3 Input
		25	Keypad Col 2 Select
		26	Keypad Col 1 Select
		27	Keypad Col 4 Select
		28	Keypad Col 3 Select
		29	Ground
		30	Ground
		31	Ground

Table 6-5. Front Panel Board Connector Pin Diagram, continued

Connector Label	Reference Designator	Pin	Signal Description
		32	Ground
		33	+24V
		34	+24V
LCD DATA	J2	1	LFLM_5V – LCD Signal
		2	LLP_5V – LCD Signal
		3	LCLK_5V – LCD Signal
		4	LCD_ONOFF_5V – LCD Signal
		5	+5V
		6	Ground
		7	LCD Bias Voltage
		8	LD0_5V – LCD Signal
		9	LD1_5V – LCD Signal
		10	LD2_5V – LCD Signal
		11	LD3_5V – LCD Signal
		12	LD4_5V – LCD Signal
		13	LD5_5V – LCD Signal
		14	LD6_5V – LCD Signal
		15	LD7_5V – LCD Signal
		16	Ground
KEYBOARD	J3	1	Keypad Row 1 Input
		2	Keypad Row 2 Input
		3	Keypad Row 3 Input
		4	Keypad Row 4 Input
		5	Keypad Col 1 Select
		6	Keypad Col 2 Select
		7	Keypad Col 3 Select
		8	Keypad Col 4 Select
LCD BACKLIGHT	J4	1	LCD Backlight Voltage 1
		2	NC
		3	NC
		4	LCD Backlight Voltage 2

Table 6-6. I/O Expansion Board (Optional) Connector Pin Descriptions

Connector Label	Reference Designator	Pin	Signal Description
EXPANSION I/O	J1	1	Analog Voltage Input 1
		2	Analog Voltage Input 2
		3	Analog Voltage Input 3
		4	Ground
		5	Analog Voltage Input 4
		6	Analog Voltage Input 5
		7	Analog Voltage Input 6
		8	Ground
		9	Analog Voltage Input 7
		10	Analog Voltage Input 8
		11	Ground
		12	NC
		13	NC
		14	Ground
		15	Current Output 1
		16	Current Output Return
		17	Current Output 2
		18	Current Output Return
		19	Current Output 3
		20	Current Output Return
		21	Current Output 4
		22	Current Output Return
		23	Current Output 5
		24	Current Output Return
		25	Current Output 6
MOTHER BD	J2	1	+5V
		2	+24V
		3	+24V
		4	Ground
		5	Ground
		6	Ground

Table 6-6. I/O Expansion Board (Optional) Connector Pin Descriptions, continued

Connector Label	Reference Designator	Pin	Signal Description
		7	+RS485 to Motherboard
		8	-RS485 to Motherboard

Table 6-7. Digital Output Board Connector Pin Descriptions

Connector Label	Reference Designator	Pin	Signal Description
MOTHER BD	J1	1	+5V
		2	+24V
		3	+24V
		4	Ground
		5	Ground
		6	Ground
		7	SPI Reset
		8	SPI Input
		9	SPI Output
		10	SPI Board Select
		11	SPI Clock
DIGITAL OUTPUTS	J2	1	Relay 1 Contact a
		2	Relay 2 Contact a
		3	Relay 3 Contact a
		4	Relay 4 Contact a
		5	Relay 5 Contact a
		6	Relay 6 Contact a
		7	Relay 7 Contact a
		8	Relay 8 Contact a
		9	Relay 9 Contact a
		10	Relay 10 Contact a
		11	NC
		12	Solenoid Drive Output 1
		13	Solenoid Drive Output 2
		14	Solenoid Drive Output 3

Table 6-7. Digital Output Board Connector Pin Descriptions, continued

Connector Label	Reference Designator	Pin	Signal Description
		15	Solenoid Drive Output 4
		16	Solenoid Drive Output 5
		17	Solenoid Drive Output 6
		18	Solenoid Drive Output 7
		19	Solenoid Drive Output 8
		20	Relay 1 Contact b
		21	Relay 2 Contact b
		22	Relay 3 Contact b
		23	Relay 4 Contact b
		24	Relay 5 Contact b
		25	Relay 6 Contact b
		26	Relay 7 Contact b
		27	Relay 8 Contact b
		28	Relay 9 Contact b
		29	Relay 10 Contact b
		30	+24V
		31	+24V
		32	+24V
		33	+24V
		34	+24V
		35	+24V
		36	+24V
		37	+24V

Table 6-8. Input Board Connector Pin Descriptions

Connector Label	Reference Designator	Pin	Signal Description
PMT IN	J1	1	PMT Input
		2	Ground
INTF BD	J2	1	+15V
		2	Ground
		3	-15V

Table 6-8. Input Board Connector Pin Descriptions, continued

Connector Label	Reference Designator	Pin	Signal Description
		4	+5V
		5	Ground
		6	Measurement Frequency Output
		7	Amplifier Zero Adjust Voltage
		8	SPI Input
		9	SPI Clock
		10	SPI Board Select

Table 6-9. Temperature Control Board Connector Pin Descriptions

Connector Label	Reference Designator	Pin	Signal Description
INTERFACE	J1	1	Bench Temperature Input
		2	Ground
		3	-15V
		4	Converter Heater On/Off
		5	Converter Temperature Input
		6	+15V_PWR
AC INPUT	J2	1	AC-HOT
		2	AC-NEUT
BENCH	J3	1	Bench Heater AC Output
		2	Bench Heater AC Return
		3	Ground
		4	Bench Thermistor
CONVERTER	J4	1	Ground
		2	Converter Heater AC Output
		3	Converter Heater AC Return
CONV TC	J5	1	Converter Thermocouple TC
		2	Converter Thermocouple TC+
SS TEMP	J6	1	SS Temperature Range Jumper A
		2	SS Temperature Range Jumper B

Service Locations

For additional assistance, service is available from exclusive distributors worldwide. Contact one of the phone numbers below for product support and technical information or visit us on the web at www.thermo.com/aqi.

1-866-282-0430 Toll Free

1-508-520-0430 International

Chapter 7 Servicing

This chapter explains how to replace the Model 42i High Level subassemblies. It assumes that a subassembly has been identified as defective and needs to be replaced.

For fault location information refer to the “Preventive Maintenance” chapter and the “Troubleshooting” chapter in this manual.

The service mode in the “Operation” chapter also includes parameters and functions that are useful when making adjustments or diagnosing problems. The service mode includes some of the same information found in the Diagnostic menu, however, readings are updated every second in the service mode compared with every 10 seconds in the Diagnostics menu.

For additional service assistance, see “Service Locations” at the end of this chapter.

This chapter includes the following parts information and component replacement procedures.

- “Safety Precautions” on page 7-3
- “Firmware Updates” on page 7-4
- “Replacement Parts List” on page 7-4
- “Cable List” on page 7-6
- “Removing the Measurement Bench and Lowering the Partition Panel” on page 7-8
- “Pump Replacement” on page 7-9
- “Replacing a Fan” on page 7-11
- “PMT Cooler and Reaction Chamber Assembly Replacement” on page 7-11
- “Photomultiplier Tube Replacement” on page 7-13

- “PMT High Voltage Power Supply Replacement” on page 7-15
- “Reaction Chamber Cleaning or Removal” on page 7-18
- “NO₂-to-NO Converter Replacement” on page 7-20
- “Solenoid Valve Replacement” on page 7-22
- “Ozonator Assembly Replacement” on page 7-23
- “Ozonator Transformer Replacement” on page 7-25
- “Input Board Replacement” on page 7-25
- “DC Power Supply Replacement” on page 7-28
- “Analog Output Adjustment” on page 7-31
- “Pressure Transducer Assembly Replacement” on page 7-32
- “Pressure Transducer Calibration ” on page 7-34
- “Temperature Control Board Replacement” on page 7-36
- “Fuse Replacement” on page 7-38
- “Scrubber Replacement” on page 7-38
- “I/O Expansion Board (Optional) Replacement” on page 7-39
- “Digital Output Board Replacement” on page 7-40
- “Motherboard Replacement” on page 7-41
- “Measurement Interface Board Replacement” on page 7-42
- “Front Panel Board Replacement” on page 7-43
- “LCD Module Replacement” on page 7-44
- “Service Locations” on page 7-46

Safety Precautions

Read the safety precautions before beginning any procedures in this chapter.



WARNING The service procedures in this manual are restricted to qualified service representatives. ▲

If the equipment is operated in a manner not specified by the manufacturer, the protection provided by the equipment may be impaired. ▲



CAUTION Carefully observe the instructions in each procedure. Avoid contact with converter heated components.

Allow converter to cool to room temperature before handling converter components. ▲



Equipment Damage Some internal components can be damaged by small amounts of static electricity. A properly grounded antistatic wrist strap must be worn while handling any internal component (Figure 7-1). If an antistatic wrist strap is not available, be sure to touch a grounded metal object before touching any internal components. When the instrument is unplugged, the chassis is not at earth ground. ▲

Handle all printed circuit boards by the edges. ▲

Do Not point the photomultiplier tube at a light source. This can permanently damage the tube. ▲

Do not remove the LCD panel or frame from the LCD module. ▲

The polarizing plate is very fragile, handle it carefully. ▲

Do not wipe the polarizing plate with a dry cloth, it may easily scratch the plate. ▲

Do not use alcohol, acetone, MEK or other Ketone based or aromatic solvents to clean the LCD module, use a soft cloth moistened with a naphtha cleaning solvent. ▲

Do not place the LCD module near organic solvents or corrosive gases. ▲

Do not shake or jolt the LCD module. ▲

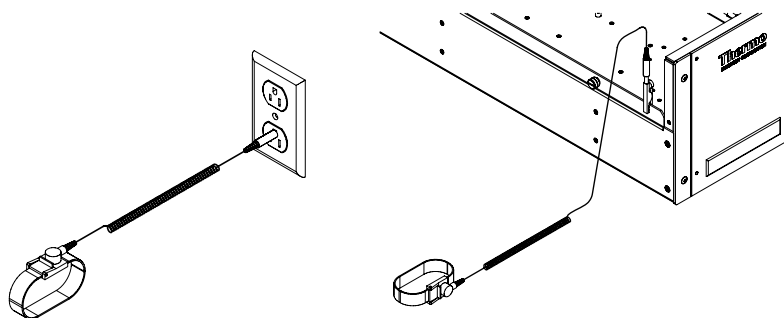

Figure 7-1. Properly Grounded Antistatic Wrist Strap

Firmware Updates

The firmware can be updated by the user in the field via the serial port or over the Ethernet. This includes both the main processor firmware and the firmware in all low-level processors. Refer to the *i-Port* manual for the firmware update procedure.

Replacement Parts List

[Table 7-1](#) lists the replacement parts for the Model 42*i* High Level major subassemblies. Refer to [Figure 7-2](#) to identify the component location.

Table 7-1. Model 42*i* High Level Replacement Parts

Part Number	Description
100480-00	Front Panel Push Button Board
101491-02	Processor Board
100533-00	Motherboard
100539-00	Digital Output Board
100542-00	I/O Expansion Board (Optional)
100859-00	Front Panel Connector Board
100536-00	Measurement Interface Board
100856-00	Temperature Control Board
101167-00	Input Board Assembly
101076-00	Front Panel Display
9973	Ozonator Assembly
9974	Ozonator Transformer
101023-00	Pressure Transducer
101620-00	Flow Switch (Ozone)
9367	Photomultiplier Tube (PMT)

Table 7-1. Model 42i High Level Replacement Parts, continued

Part Number	Description
101024-00	PMT High Voltage Power Supply
9981	PMT Base Socket Assembly
101390-00	Solenoid Valve
101020-00	Cooler Assembly
102648-02	Reaction Chamber Assembly
101214-00	NO ₂ -to-NO Converter Assembly (Stainless Steel 110VAC)
9467	Stainless Steel Converter Cartridge
9456	Pump 120VAC, 60Hz
8079	Pump 110VAC, 50Hz
9457	Pump 220VAC, 50Hz
8500	Pump 220VAC, 60Hz
8080	Pump 100VAC, 50-60Hz
9464	Pump Repair Kit
101055-00	AC Receptacle Assembly -include in this parts list?
101681-00	Power Supply Assembly, 24VDC, w/Base Plate and Screws
100907-00	Fan, 24VDC
101905-00	Fuse, 250VAC, 4.0 Amp, SlowBlow (for 100VAC and 110VAC models)
101904-00	Fuse, 250VAC, 2.0 Amp, SlowBlow (for 220-240VAC models)
101399-00	Transformer, 220-240VAC (Optional)
101863-00	Transformer, 100VAC (Optional)
4121	Capillary (ozone) 0.01 inch ID
4113	Capillary (sample) 0.005 inch ID
4119	Capillary (sample) 0.008 inch ID (red)
4126	Capillary (bypass flow option) 0.020 inch ID (purple)
4800	O-ring, Capillary (pk/10)
8630	Filter Guard Assembly (w/foam)
4338	Optical Filter Kit
6556	Optical Filter Assembly
101562-00	Terminal Block and Cable Kit (DB25)
101556-00	Terminal Block and Cable Kit (DB37)

Cable List

Table 7-2 describes the Model 42i High Level spare cables. See the “Troubleshooting” chapter for associated connection diagrams and board connector pin descriptions.

Table 7-2. Model 42i High Level Cables

Part Number	Description
101346-00	Temperature Control
101355-00	Signal Input
101688-00	Ambient Temperature
101695-00	Permeator Oven
101050-00	Heater Power
101036-00	DC Power Supply 24V Output
101037-00	115VAC Supply to Interface Board
101048-00	RS-485/Data
101038-00	Power Switch to Motherboard
101364-00	DC Power Supply Status Monitor
101055-00	Main AC Receptacle Assembly
101054-00	Motherboard to Front Panel Board
101035-00	DC Power Supply AC Input
101033-00	AC from Outlet
101377-00	AC to Power Switch
102057-00	AC to External Pump
101267-00	Fan Power Cable

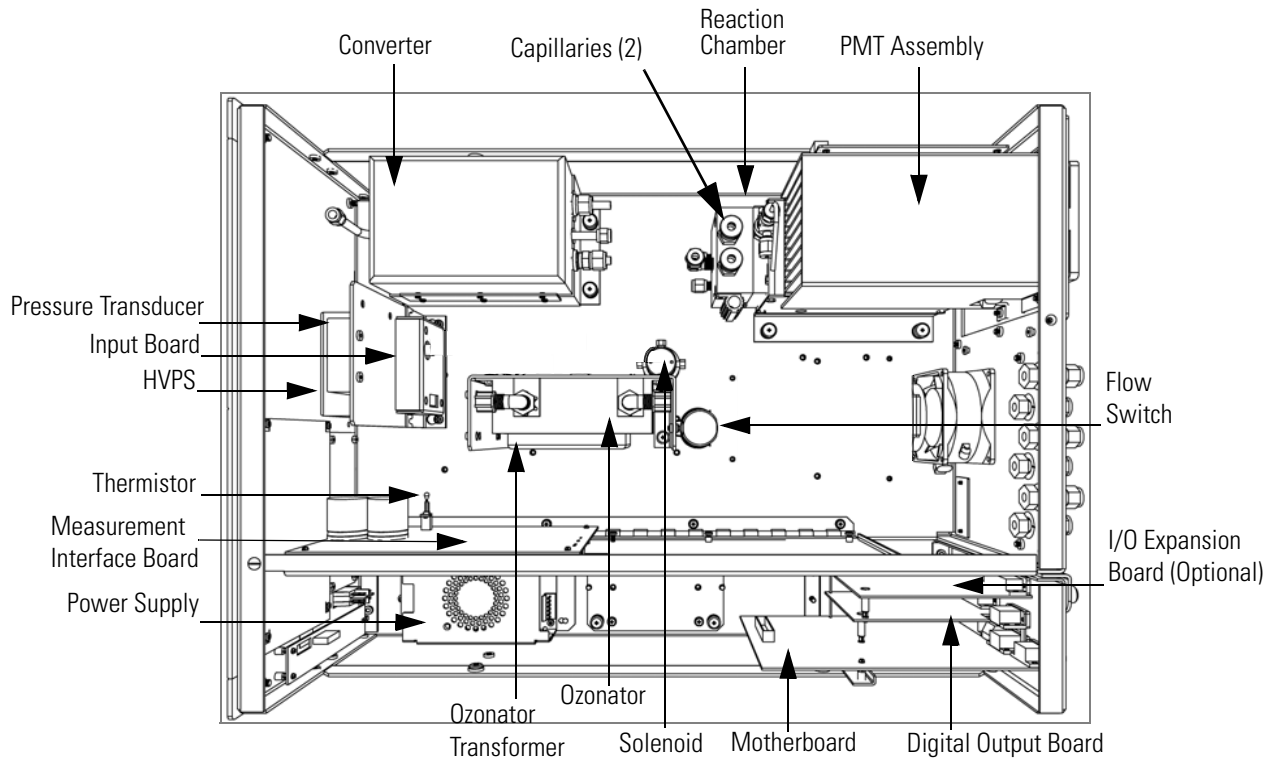

Figure 7-2. Component Layout

Servicing

Removing the Measurement Bench and Lowering the Partition Panel

Removing the Measurement Bench and Lowering the Partition Panel

The measurement bench can be removed and the partition panel can be lowered to improve access to connectors and components. Refer to the following steps when a procedure requires lowering the partition panel (see [Figure 7-3](#)).

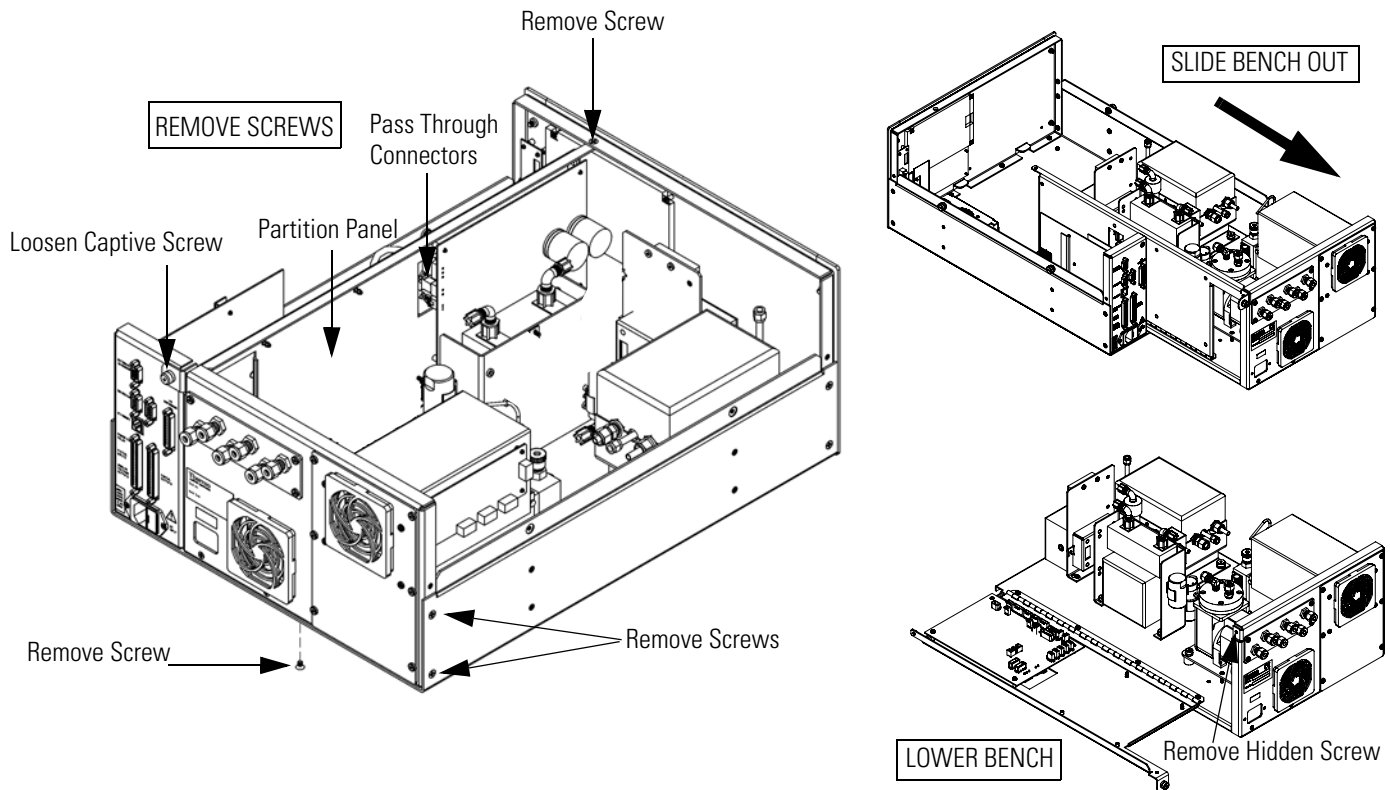

Figure 7-3. Removing the Measurement Bench and Lowering the Partition Panel

Equipment Required:

Philips screwdriver



Equipment Damage Some internal components can be damaged by small amounts of static electricity. A properly grounded antistatic wrist strap must be worn while handling any internal component. ▲

1. Turn instrument OFF and unplug the power cord.
2. If the instrument is mounted in a rack, remove it from the rack.

3. Remove the cover.
4. Disconnect the plumbing connections at the rear of the measurement bench.
5. Disconnect the three connectors that pass through the center of the partition panel.
6. Remove two screws from the left side of the case (viewed from front).
7. Remove one screw from the bottom front of the case.
8. Remove one screw from the top front of the partition panel.
9. While holding the case securely, loosen the captive screw at the rear of the measurement bench, and pull the measurement bench from the rear of the case.
10. Remove the screw at the top rear of the partition panel securing the top of partition panel to the measurement bench, and lower the panel being careful not to put excessive tension on the cables.
11. Replace the measurement bench by following previous steps in reverse.

Pump Replacement

Use the following procedure to replace the pump (see [Figure 7-4](#)). To rebuild the pump, see “Pump Rebuilding” in the “Preventive Maintenance” chapter.

Equipment Required:

110V pump or 220V pump

Wrench, 9/16-inch

1. Disconnect the pump power line from the AC power outlet.

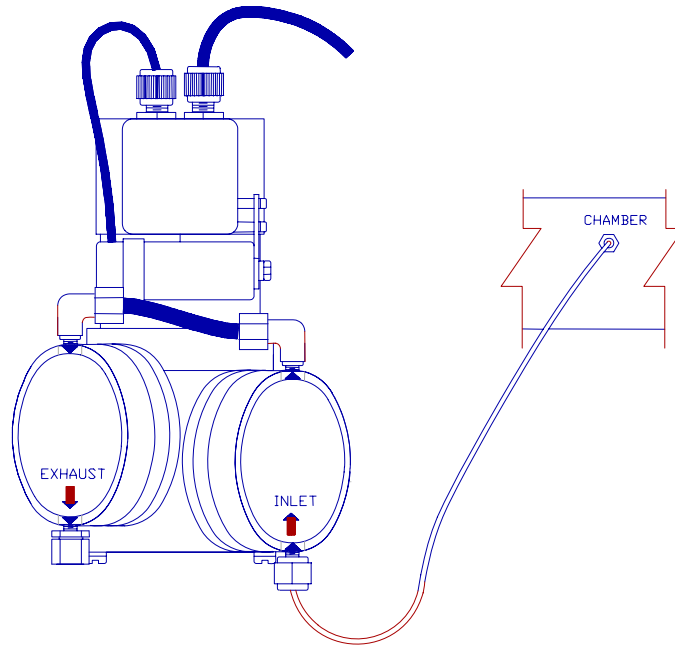

Figure 7-4. Replacing the Pump

2. Remove both inlet and exhaust lines from the pump.
3. Install the new pump by following the previous steps in reverse.

Fan Replacement

Use the following procedure to replace the fan (Figure 7-5).

Equipment Required:

Fan

Philips screwdriver



Equipment Damage Some internal components can be damaged by small amounts of static electricity. A properly grounded antistatic wrist strap must be worn while handling any internal component. ▲

1. Turn instrument OFF, unplug the power cord, and remove the cover.
2. Remove the fan guard from the fan and remove the filter.

3. Pull the power connectors off the fan.
4. Remove the four fan mounting screws and remove the fan.
5. Install a new fan following the previous steps in reverse.

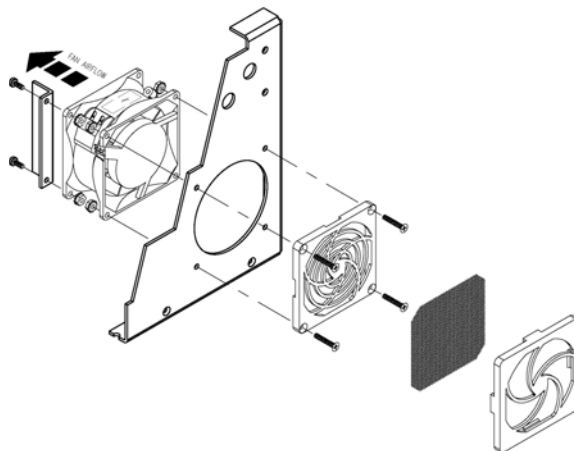

Figure 7-5. Replacing a Fan

PMT Cooler and Reaction Chamber Assembly Replacement

Use the following procedure to replace the PMT cooler and reaction chamber assembly (see [Figure 7-6](#)).

Equipment Required:

PMT cooler

Wrench, 7/16-inch

Wrench, 9/16-inch

Nut driver, 1/4-inch

Philips screwdriver

Wire cutters



Equipment Damage Some internal components can be damaged by small amounts of static electricity. A properly grounded antistatic wrist strap must be worn while handling any internal component. ▲

Servicing

PMT Cooler and Reaction Chamber Assembly Replacement

1. Refer to “Removing the Measurement Bench and Lowering the Partition Panel” in this chapter to lower the partition panel, then proceed to the next step below.
2. Disconnect the reaction chamber connector from the temperature control board.
3. Snap off the temperature control board from the board mounts.
4. Remove the four screws securing the cooler shroud and remove the shroud.

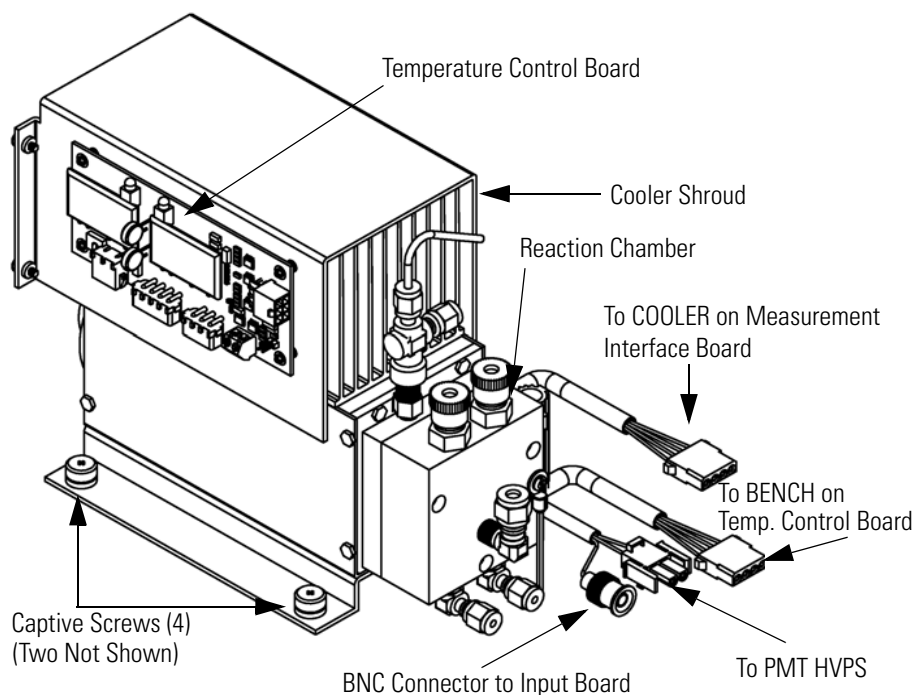

Figure 7-6. PMT Cooler and Reaction Chamber

5. Disconnect plumbing connections from the reaction chamber.
6. Disconnect the PMT cooler cables from the PMT high voltage power supply, the input board, and the measurement interface board. Remove all tie-wraps securing the cables.

7. Loosen four captive screws holding cooler to floor plate and remove the cooler assembly with the reaction chamber.

Note If only the cooler is being replaced, remove the PMT and reaction chamber from the old cooler and install them on the new cooler. ▲

Fasten knurled fittings on reaction chamber finger tight. ▲

Make sure that the heat shrink covered tubing between the reaction chamber and the converter is light tight at the connections. ▲

8. Install new cooler by following previous steps in reverse.
9. Re-install the measurement bench. Refer to “Removing the Measurement Bench and Lowering the Partition Panel” in this chapter.

Photomultiplier Tube Replacement

Use the following procedure to replace the PMT tube.

Equipment Required:

Photomultiplier tube and PMT base

Nut driver, 5/16-inch

Flat blade screwdriver

Philips screwdriver, small



Equipment Damage Some internal components can be damaged by small amounts of static electricity. A properly grounded antistatic wrist strap must be worn while handling any internal component. ▲

1. Turn instrument OFF, unplug the power cord, and remove the cover.
2. Disconnect the high voltage cable from the PMT power supply and unplug the BNC cable from the Input Board.
3. Remove six external screws holding PMT cover plate and the four screws holding the PMT shroud to the panel and remove the PMT

Servicing

Photomultiplier Tube Replacement

cover plate (Figure 7-7). If the cooler fan is attached, unplug the fan power cord if necessary.

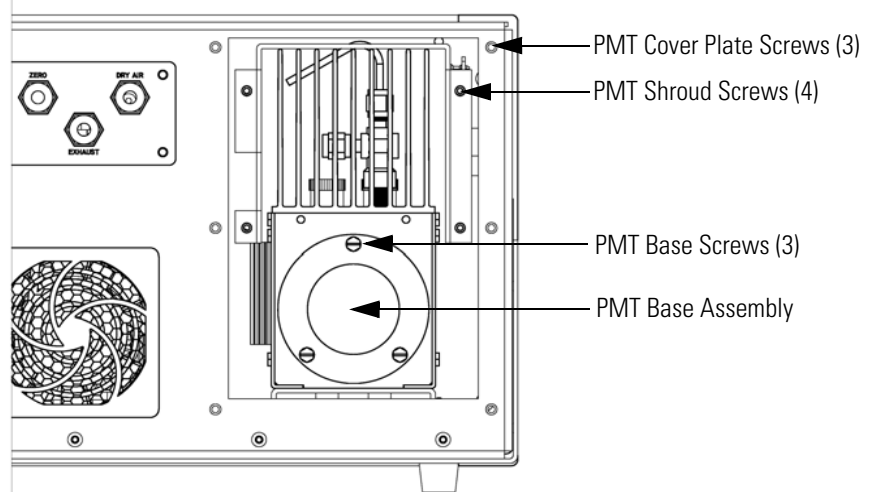

Figure 7-7. Replacing the PMT

4. Remove the three retaining screws holding PMT base assembly to the cooler using a 5/16-inch nut driver.



Equipment Damage Do not point the photomultiplier tube at a light source. This can permanently damage the tube. ▲

5. Pull the PMT and PMT base from cooler assembly by twisting it slightly back and forth.
6. To install PMT, follow previous steps in reverse making sure to backfill the cooler with dry air or nitrogen prior to replacing the PMT.
7. Perform a photomultiplier tube calibration. See “Photomultiplier Tube Calibration” in the “Operation” chapter.

PMT High Voltage Power Supply Replacement

Use the following procedure to replace the PMT high voltage power supply (Figure 7-8).

Equipment Required:

PMT high voltage power supply

Nut driver, 1/4-inch

Philips screwdriver



Equipment Damage Some internal components can be damaged by small amounts of static electricity. A properly grounded antistatic wrist strap must be worn while handling any internal component. ▲

1. Turn instrument OFF, unplug the power cord, and remove the cover.
2. Disconnect the two PMT high voltage supply cables.
3. Loosen the two retaining screws securing the assembly bracket to the floor plate and slide the assembly towards the rear slightly and lift it off the base screws.

Servicing

PMT High Voltage Power Supply Replacement

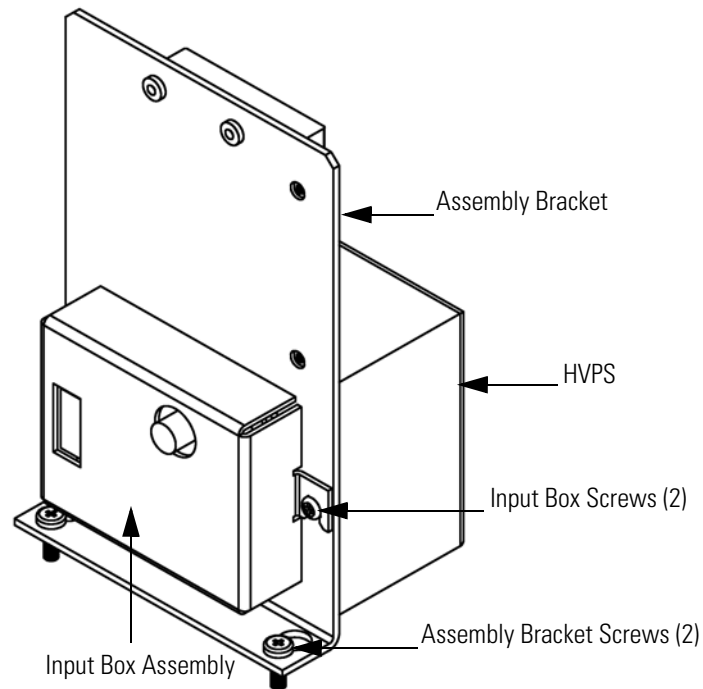

Figure 7-8. Replacing the PMT HVPS





4. Loosen two screws on the input box assembly and lift the input box assembly off the power supply.
5. Remove the four screws securing the power supply to the bracket and remove the power supply.
6. To install the power supply, follow the previous steps in reverse.
7. Recalibrate the instrument. Refer to the calibration procedures in the “Calibration” chapter.

PMT Voltage Adjustment

Use the following procedure to adjust the PMT voltage after switching from standard to extended ranges or vice versa.











WARNING The service procedures in this manual are restricted to qualified service representatives. ▲

1. Select the NO, NO₂, and NO_x ranges. Refer to “Range Menu” in the “Calibration” chapter.
2. Set the NO BKG and NO_x BKG calibration factors to 0.0. Refer to “Calibration Factors Menu” in the “Calibration” chapter.
3. Set the NO COEF, NO_x COEF, and NO₂ COEF to 1.000.
4. Set the Averaging Time to 10 seconds. Refer to “Averaging Time” in the “Calibration” chapter.
5. Connect the calibration gas and allow the instrument to sample calibration gas until the reading stabilizes.
6. From the Main Menu, press  to scroll to Service > press  >  to scroll to **PMT Voltage Adjustment** > and press .

The Set PMT Voltage screen appears.

If the Service Mode is not displayed on the Main Menu, use the following procedure to display it.

- a. At the Main Menu, press  to scroll to Instrument Controls > press  >  to scroll to **Service Mode** > and press .
- The Service Mode screen appears.
- b. Press  to toggle the Service Mode to ON.
 - c. Press  >  to return to the Main Menu.
 - d. Continue the procedure at the beginning of Step 6 to display the Set PMT Voltage screen.

7. At the Set PMT Voltage screen, use   to increment/decrement the counts until the instrument displays the calibration gas concentration value.

Reaction Chamber Cleaning or Removal

Use the following procedure to clean and/or remove the reaction chamber (see [Figure 7-9](#)).

Equipment Required:

Allen Wrench, 9/64-inch

Wrench, 7/16-inch

Wrench, 9/16-inch



Equipment Damage Some internal components can be damaged by small amounts of static electricity. A properly grounded antistatic wrist strap must be worn while handling any internal component. ▲

1. Remove PMT cooler as described in “PMT Cooler and Reaction Chamber Replacement” in this chapter.
2. Disconnect the 1/8-inch line at the mixing tee on the rear of the reaction chamber. This line is connected to the left 1/8-inch elbow at the bottom of the front of the reaction chamber.
3. Disconnect 1/4-inch fitting from the exhaust elbow on the front of the reaction chamber.
4. Disconnect 1/8-inch fitting from 1/8-inch elbow at the bottom of the front of the reaction chamber.
5. Remove the three socket head screws fastening front of reaction chamber to rear. This exposes the inner surfaces of both sections of the

reaction chamber and the quartz window. To clean these surfaces use cotton swabs and methanol.

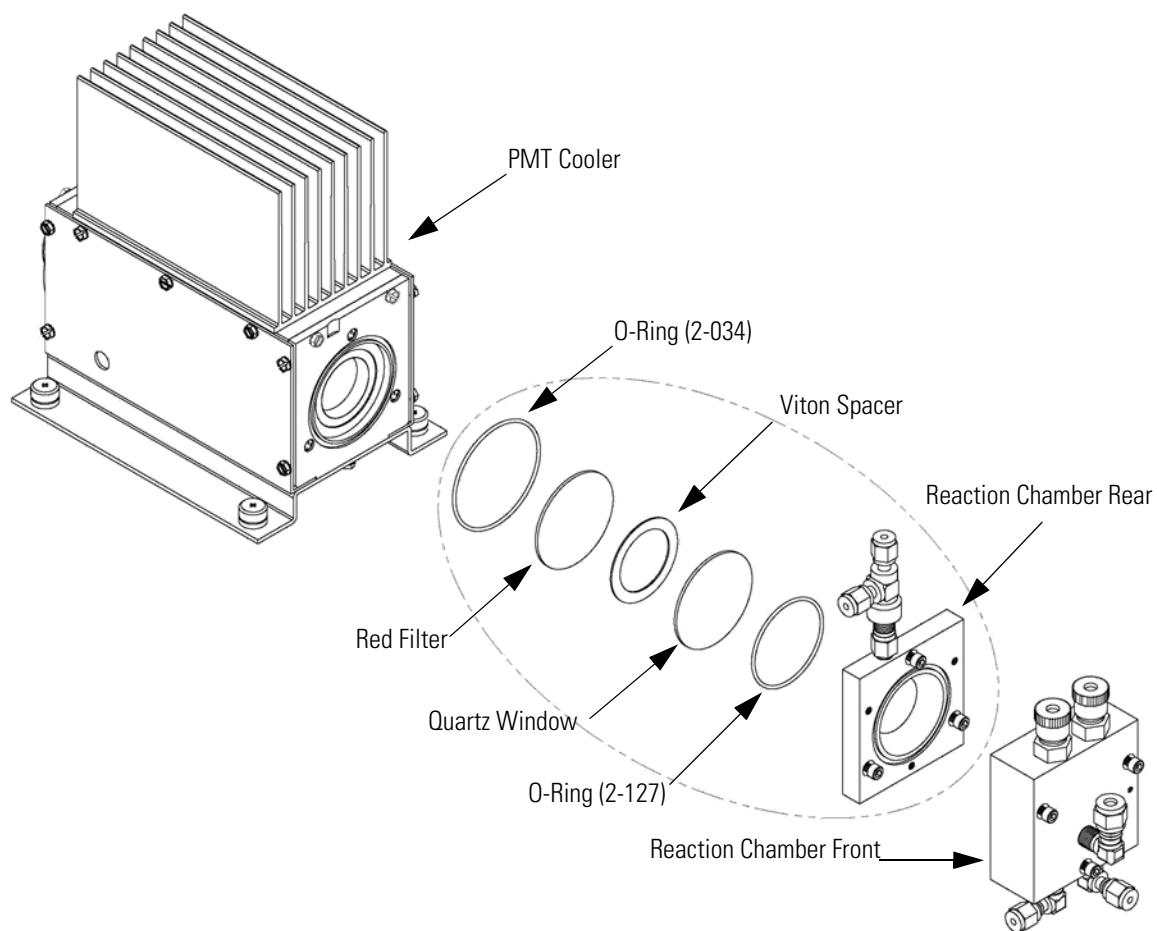

Figure 7-9. Cleaning or Removing the Reaction Chamber

6. To continue removing rear of reaction chamber remove the three socket head screws holding it to cooler, being careful to keep quartz window and red filter in cooler body.
7. To reinstall reaction chamber, follow previous steps in reverse, making sure to backfill the cooler with dry air or nitrogen prior to installing reaction chamber.
8. Re-install the measurement bench. Refer to “Removing the Measurement Bench and Lowering the Partition Panel” in this chapter.

NO₂-to-NO Converter Replacement

Use the following procedure to replace the converter (Figure 7-10).

Equipment Required:

NO₂-to-NO Converter

Wrench, 7/16-inch

Wrench, 9/16-inch

Wrench, 1/2-inch

Wrench, 5/8-inch

Screwdriver

Nut driver, 1/4-inch

Nut driver, 5/16-inch



CAUTION Avoid contact with converter heated components. Allow converter to cool to room temperature before handling converter components. ▲



Equipment Damage Some internal components can be damaged by small amounts of static electricity. A properly grounded antistatic wrist strap must be worn while handling any internal component. ▲

1. Turn instrument OFF, unplug the power cord, and remove the cover.
2. Allow converter to cool to room temperature to prevent contact with heated components.
3. Disconnect plumbing at converter inlet and outlet.
4. Disconnect thermocouple leads and heater connector from temperature control board.

5. Loosen the four captive screws holding converter housing to floor plate.

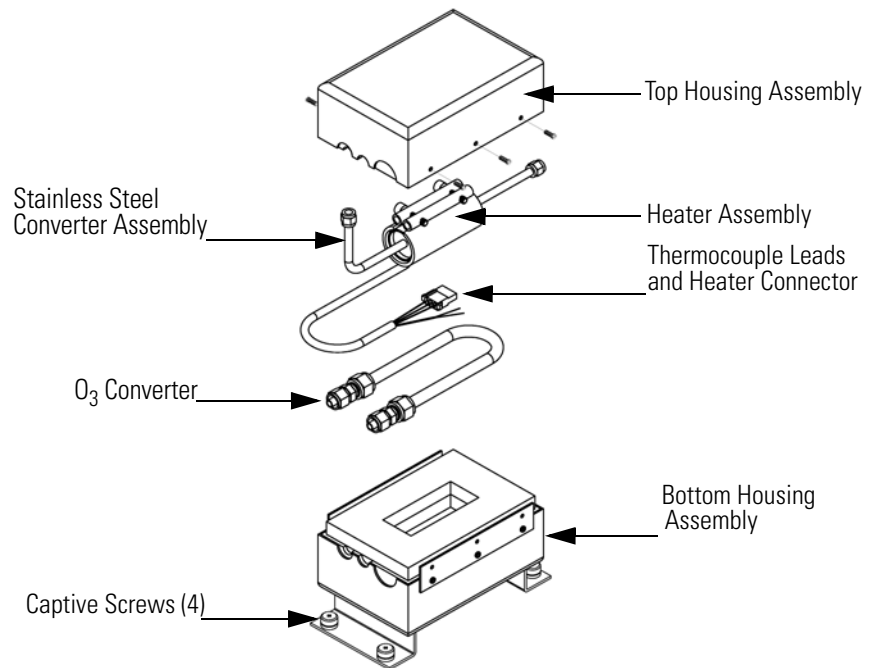

Figure 7-10. NO₂-to-NO Stainless Steel Converter Assembly

6. Remove the six screws holding the top housing assembly to the bottom half.
7. Remove the converter cartridge/heater assembly from the bottom housing assembly.
8. Loosen the heater clamp, pry heater apart no wider than necessary and remove the converter cartridge noting the proper orientation of heater wires and thermocouple probe.
9. To replace converter, follow previous steps in reverse. Be sure to wrap the O₃ converter tube snugly around the heater.

Solenoid Valve Replacement

Use the following procedure to replace the solenoid valve (Figure 7-11).

Equipment Required:

Solenoid valve

Wrench, 5/16-inch

Philips screwdriver



Equipment Damage Some internal components can be damaged by small amounts of static electricity. A properly grounded antistatic wrist strap must be worn while handling any internal component. ▲

1. Refer to “Removing the Measurement Bench and Lowering the Partition Panel” in this chapter to lower the partition panel, then proceed to the next step below.
2. Disconnect solenoid from the Measurement Interface board (NO/NO_x connector). Note electrical connections to facilitate re-connection.
3. Remove plumbing from solenoid. Note plumbing connections to facilitate re-connection.
4. Pull solenoid valve from mounting clip.
5. To replace solenoid, follow above in reverse.
6. Re-install the measurement bench. Refer to “Removing the Measurement Bench and Lowering the Partition Panel” in this chapter.

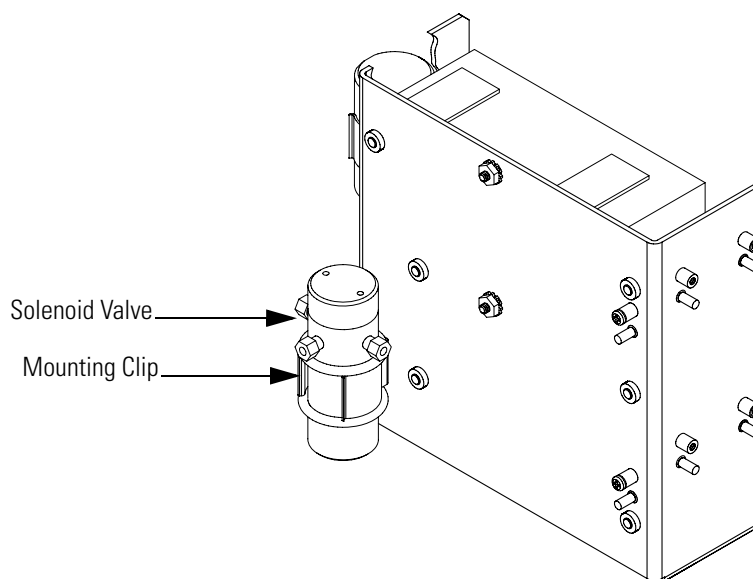

Figure 7-11. Replacing the Solenoid Valve

Ozonator Assembly Replacement

Use the following procedure to replace the ozonator assembly (Figure 7-12).

Equipment Required:

Ozonator assembly

Wrench, 5/8-inch

Philips screwdriver



Equipment Damage Some internal components can be damaged by small amounts of static electricity. A properly grounded antistatic wrist strap must be worn while handling any internal component. ▲

1. Refer to “Removing the Measurement Bench and Lowering the Partition Panel” in this chapter to lower the partition panel, then proceed to the next step below.
2. Carefully disconnect the plumbing at the glass inlet and outlet of the ozonator.

Servicing

Ozonator Assembly Replacement

3. Loosen the four captive screws securing the ozonator bracket to the floor plate.

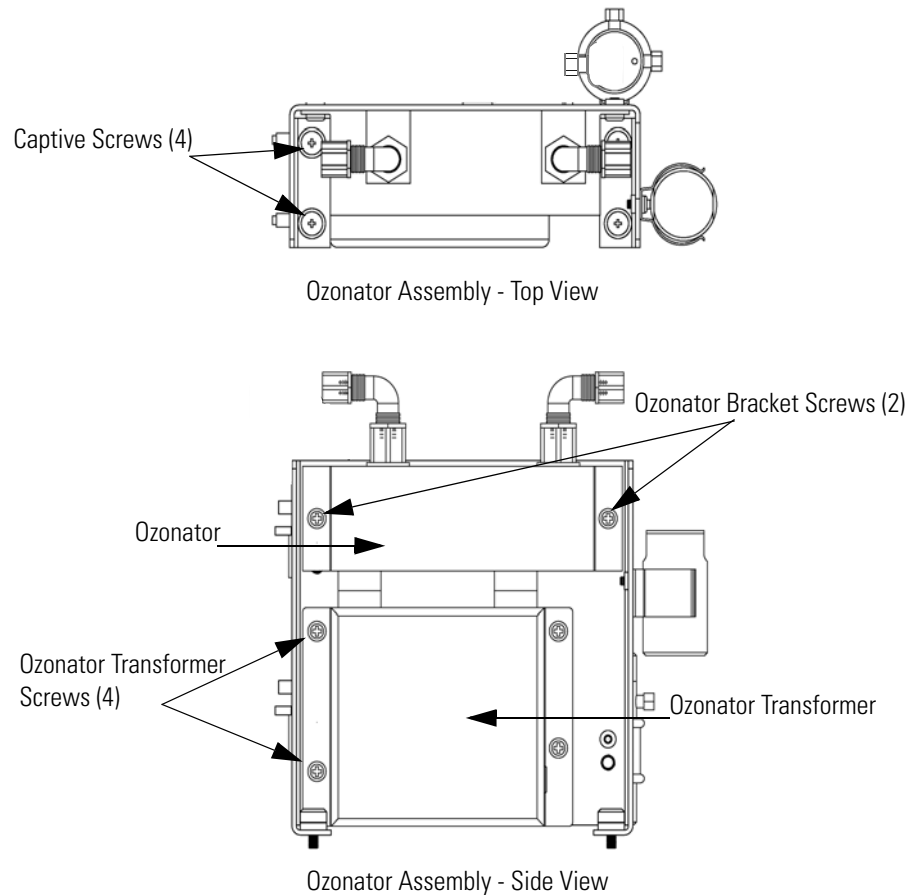

Figure 7-12. Replacing the Ozonator Assembly

4. Remove the two screws securing the ozonator to the ozonator bracket.
5. Unplug the ozonator from the ozonator transformer by lifting the ozonator straight up.
6. To install the ozonator, follow the previous steps in reverse.
7. Re-install the measurement bench. Refer to “Removing the Measurement Bench and Lowering the Partition Panel” in this chapter.

Ozonator Transformer Replacement

Use the following procedure to replace the ozonator transformer (Figure 7-12).

Equipment Required:

Ozonator transformer

Philips screwdriver



Equipment Damage Some internal components can be damaged by small amounts of static electricity. A properly grounded antistatic wrist strap must be worn while handling any internal component. ▲

1. Turn instrument OFF, unplug the power cord, and remove the cover.
2. Remove the ozonator assembly as described in “Ozonator Assembly Replacement.”
3. Disconnect the plug connecting the ozonator transformer to the measurement interface board (OZONATOR connector).
4. Remove the four screws holding the ozonator transformer to the ozonator bracket and remove the ozonator transformer.
5. To install the ozonator transformer, follow the previous steps in reverse.
6. Re-install the measurement bench. Refer to “Removing the Measurement Bench and Lowering the Partition Panel” in this chapter.

Input Board Replacement

Use the following procedure to replace the input board (Figure 7-13).

Equipment Required:

Input board

Philips screwdriver



Equipment Damage Some internal components can be damaged by small amounts of static electricity. A properly grounded antistatic wrist strap must be worn while handling any internal component. ▲

1. Refer to “Removing the Measurement Bench and Lowering the Partition Panel” in this chapter to lower the partition panel, then proceed to the next step below.
2. Disconnect the BNC signal and the ribbon cable.
3. Loosen the two screws holding the assembly bracket to the floor plate, move the assembly towards the rear, and lift the assembly off the screws.
4. Loosen the two screws holding the input box to the assembly bracket and lift the input box off the screws.

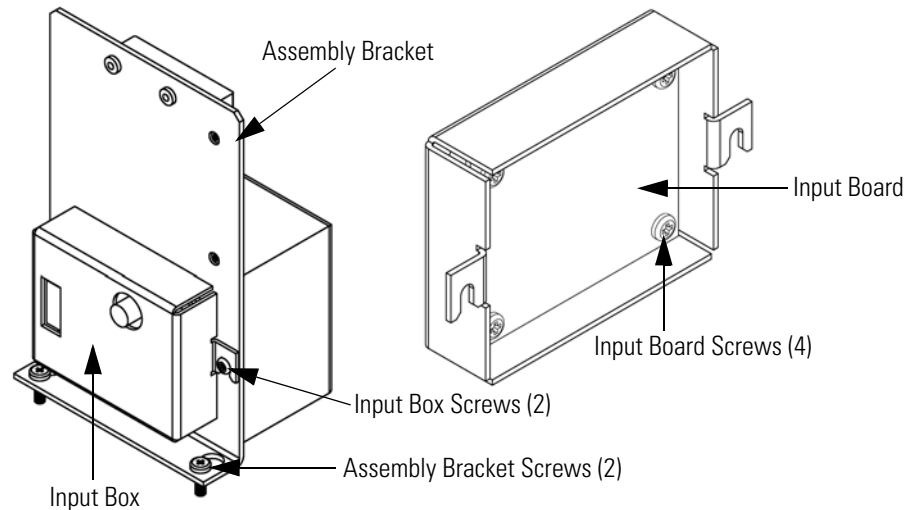

Figure 7-13. Replacing the Input Board

5. Remove the four screws holding the input board to the input box and remove the input board.
6. Install the input board by following the previous steps in reverse.

7. Re-install the measurement bench. Refer to “Removing the Measurement Bench and Lowering the Partition Panel” in this chapter.
8. Perform an input board calibration. See the “Input Board Calibration” procedure that follows.

Input Board Calibration

After replacing the input board, use the following procedure to calibrate the input board.







WARNING The service procedures in this manual are restricted to qualified service representatives. ▲





1. From the Main Menu, press  to scroll to Service > press  >  to scroll to **Input Board Calibration** > and press .

The Input Board Calibration screen appears.



If the Service Mode is not displayed on the Main Menu, use the following procedure to display it.



- a. At the Main Menu, press  to scroll to Instrument Controls > press  >  to scroll to Service Mode > and press .

The Service Mode screen appears.

- b. Press  to toggle the Service Mode to ON.
 - c. Press  >  to return to the Main Menu.
 - d. Continue the procedure at the beginning of Step 1 to access the Set PMT Voltage screen.
2. At the Input Board Calibration screen, press  to select Manual Input Cal, and press  to calibrate.

The screen displays the frequency at GAIN 1.

3. Make a note of the FREQ value displayed at GAIN 1, then press  or  to change the GAIN to 100.

4. At the GAIN 100 screen, use   to increment the D/A counts until the FREQ value matches or is slightly above (within 50 counts) the value noted in the previous step.
5. Press  to store the value.

The screen flashes **Calculating - Please Wait!** and **Done - Values Saved!** messages.

DC Power Supply Replacement

Use the following procedure to replace the DC power supply ([Figure 7-14](#)).

Equipment Required:

DC power supply

Philips screwdriver



Equipment Damage Some internal components can be damaged by small amounts of static electricity. A properly grounded antistatic wrist strap must be worn while handling any internal component. ▲

1. Turn instrument OFF, unplug the power cord, and remove the cover.
2. Disconnect all the power supply electrical connections. Note connector locations to facilitate re-connection.
3. Loosen the captive screw securing the power supply to the chassis plate and lift out the power supply.

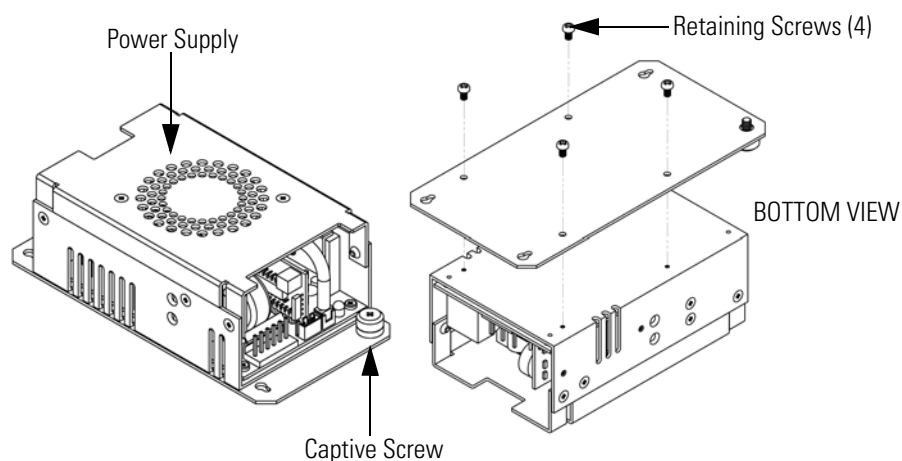

Figure 7-14. Replacing the DC Power Supply

4. Turn the power supply upside down and remove the four retaining screws securing the power supply to the power supply plate and remove the power supply.
5. To install the DC power supply, follow the previous steps in reverse.

Analog Output Testing

The analog outputs should be tested if the concentration value on the front panel display disagrees with the analog outputs. To check the analog outputs, you connect a meter to an analog voltage output channel and compare the meter reading with the output value set on the Test Analog Outputs screen.

Use the following procedure to test the analog outputs.

1. Connect a meter to the channel to be tested. [Figure 7-15](#) shows the analog output pins and [Table 7-3](#) identifies the associated channels.

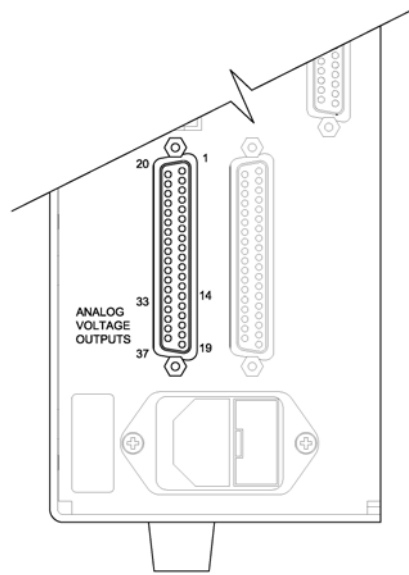

Figure 7-15. Rear Panel Analog Voltage Output Pins

Table 7-3. Analog Output Channels and Rear Panel Pin Connections

Channel	Pin
1	14
2	33
3	15
4	34
5	17
6	36
Ground	16, 18, 19, 35, 37

2. From the Main Menu, press to scroll to Diagnostics, > press > to scroll to Test Analog Outputs, and press .

The Test Analog Outputs screen appears.

3. Press to scroll to the channel (Voltage Channel 1-6) corresponding to the rear panel terminal pin where the meter is connected, and press .

The Set Analog Outputs screen appears.

4. Press  to set the output to full scale.

The Output Set To: field displays Full Scale.

5. Check that the meter is displaying the full scale value. If the meter reading differs by more than one percent, the analog outputs should be adjusted. Refer to the “Analog Output Adjustment” procedure that follows.

6. Press  to set the output to zero.





The Output Set To: field displays Zero.

7. Check that the meter is displaying a zero value. If the meter reading differs by more than one percent, the analog outputs should be adjusted. Refer to the “Analog Output Adjustment” procedure that follows.

Analog Output Adjustment





Use the following procedure to adjust the analog voltage outputs if a meter reading in the “Analog Output Testing” procedure differed by more than one percent.

1. Connect a meter to the channel to be adjusted. [Figure 7-15](#) shows the analog output pins and [Table 7-3](#) identifies the associated channels.

2. From the Main Menu, press  to scroll to Service > press  >  to scroll to Analog Output Calibration > and press .

The Analog Output Cal screen appears





If the Service Mode is not displayed on the Main Menu, use the following procedure to display it.

- a. At the Main Menu, press  to scroll to Instrument Controls > press  >  to scroll to Service Mode > and press .

The Service Mode screen appears.

Servicing



Pressure Transducer Assembly Replacement

- b. Press  to toggle the Service Mode to ON.
 - c. Press  >  to return to the Main Menu.
 - d. Continue the procedure at Step 2.
3. At the Analog Output Cal screen, press  to scroll to the channel (Voltage Channel 1-6) corresponding to the rear panel terminal pin where the meter is connected, then press .

The Analog Output Cal: screen appears.



4. With the cursor at Calibrate Zero, press .

The Analog Output Cal: line displays Zero



5. Use   until the meter reads 0V, then press  to save the value.

6. Press  to return to the Analog Output Cal: screen.

The Analog Output Cal: screen appears.

7. Press   to select Calibrate Full Scale.

The Analog Output Cal: Span screen appears.

8. Use   until the meter reads the value shown in the Set Output To: line, then press  to save the value.

Pressure Transducer Assembly Replacement

Use the following procedure to replace the pressure transducer assembly (Figure 7-16).

Equipment Required:

Pressure transducer assembly

Philips screwdriver



Equipment Damage Some internal components can be damaged by small amounts of static electricity. A properly grounded antistatic wrist strap must be worn while handling any internal component. ▲

1. Turn instrument OFF, unplug the power cord, and remove the cover.
2. Disconnect plumbing from the pressure transducer assembly. Note the plumbing connections to facilitate reconnection.
3. Disconnect the pressure transducer cable.

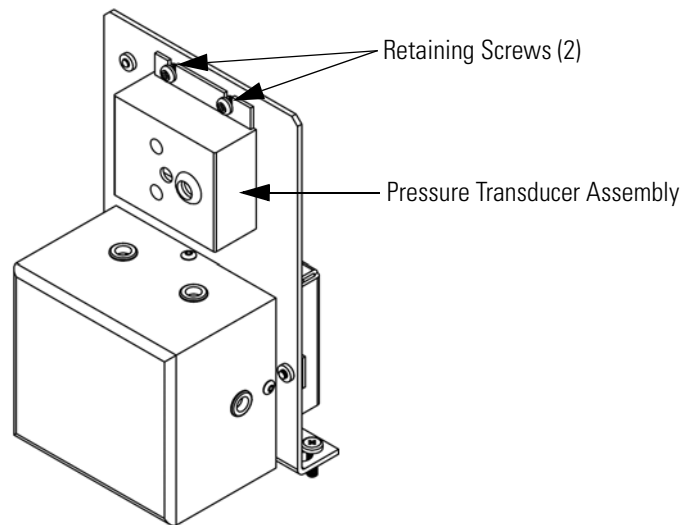

Figure 7-16. Replacing the Pressure Transducer

4. Remove the two pressure transducer assembly retaining screws and remove the pressure transducer assembly.
5. To install the pressure transducer assembly, follow previous steps in reverse.
6. Calibrate the pressure transducer. Refer to the “Pressure Transducer Calibration” procedure that follows.

Pressure Transducer Calibration

Use the following procedure to calibrate the pressure transducer.

Equipment Required:

Vacuum pump



WARNING The service procedures in this manual are restricted to qualified service representatives. ▲

If the equipment is operated in a manner not specified by the manufacturer, the protection provided by the equipment may be impaired. ▲







Equipment Damage Some internal components can be damaged by small amounts of static electricity. A properly grounded antistatic wrist strap must be worn while handling any internal component. ▲

Note An error in the zero setting of the pressure transducer does not introduce a measurable error in the output concentration reading. Therefore, if only a barometer is available and not a vacuum pump, only adjust the span setting.

















A rough check of the pressure accuracy can be made by obtaining the current barometric pressure from the local weather station or airport and comparing it to the pressure reading. However, since these pressures are usually corrected to sea level, it may be necessary to correct the reading to local pressure by subtracting 0.027 mm Hg per foot of altitude.

Do not try to calibrate the pressure transducer unless the pressure is known accurately. ▲

1. Remove the cover.
2. Disconnect the tubing from the pressure transducer and connect a vacuum pump known to produce a vacuum less than 1 mm Hg.
3. From the Main Menu, press  to scroll to Service > press  >  to scroll to **Pressure Calibration** > and press .

The Pressure Sensor Cal screen appears

If the Service Mode is not displayed on the Main Menu, use the following procedure to display it.

- a. At the Main Menu, press  to scroll to Instrument Controls > press  >  to scroll to Service Mode > and press .
The Service Mode screen appears.
 - b. Press  to toggle the Service Mode to ON.
 - c. Press  >  to return to the Main Menu.
 - d. Continue the procedure at Step 3 to access the Pressure Sensor Cal screen.
4. At the Pressure Sensor Cal screen, press  to select **Zero**.
The Calibrate Pressure Zero screen appears.
 5. Wait at least 10 seconds for the zero reading to stabilize, then press  to save the zero pressure value.
 6. Disconnect the pump from the pressure transducer.
 7. Press  to return to the Pressure Sensor Cal screen.
 8. At the Pressure Sensor Cal screen, press   to select **Span**.
The Calibrate Pressure Span screen appears.
 9. Wait at least 10 seconds for the ambient reading to stabilize, use   and   to enter the known barometric pressure, and press  to save the pressure value.
 10. Reconnect the instrument tubing to the pressure transducer.
 11. Install the cover.

Temperature Control Board Replacement

Use the following procedure to replace the temperature control board (Figure 7-6).

Equipment Required:

Temperature control board

Small flat-blade screwdriver



Equipment Damage Some internal components can be damaged by small amounts of static electricity. A properly grounded antistatic wrist strap must be worn while handling any internal component. ▲

1. Turn instrument OFF, unplug the power cord, and remove the cover.
2. Disconnect all connectors from the temperature control board. Use a small flat-blade screwdriver to loosen the two screws securing the CONV TC cable. Note that the red wire is towards the rear and the yellow wire is towards the front.
3. Snap off the board from the board mounts.
4. To install the temperature control board, follow previous steps in reverse.

Ambient Temperature Calibration

Use the following procedure to calibrate the ambient internal temperature for the instrument.

Equipment Required:

Calibrated thermometer or 10K \pm 1% Resistor



WARNING The service procedures in this manual are restricted to qualified service representatives. ▲

If the equipment is operated in a manner not specified by the manufacturer, the protection provided by the equipment may be impaired. ▲







Equipment Damage Some internal components can be damaged by small amounts of static electricity. A properly grounded antistatic wrist strap must be worn while handling any internal component. ▲

1. Remove the instrument cover.
2. Tape the thermistor (plugged into the measurement interface board) to a calibrated thermometer (Figure 7-2).





Note Since the thermistors are interchangeable to an accuracy of ± 0.2 °C, and have a value of 10K ohms at 25 °C, an alternate procedure is to connect an accurately known 10K resistor to the thermistor input (AMB TEMP) on the measurement interface board, and enter the temperature reading. ▲

A 1 °C change corresponds to a $\pm 5\%$ change in resistance, thus this alternative procedure can be quite accurate as a check; however, it clearly is not NIST traceable. ▲



3. From the Main Menu, press  to scroll to Service > press  >  to scroll to **Temperature Calibration** > and press .





The Calibrate Ambient Temperature screen appears.

If the Service Mode is not displayed on the Main Menu, use the following procedure to display it.

- a. At the Main Menu, press  to scroll to Instrument Controls > press  >  to scroll to Service Mode > and press .

The Service Mode screen appears.

- b. Press  to toggle the Service Mode to ON.
- c. Press  >  to return to the Main Menu.
- d. Continue the procedure at the beginning of Step 3 to access the Calibrate Ambient Temperature screen.

4. Wait at least 10 seconds for the ambient reading to stabilize, use   and   to enter the known temperature, and press  to save the temperature value.

5. Install the cover.

Fuse Replacement

Use the following procedure to replace the fuse.

Equipment Required:

Replacement fuses:

250VAC, 4 Amp, SlowBlow (for 100VAC and 110VAC models)

250VAC, 2 Amp, SlowBlow (for 220-240VAC models)

1. Turn instrument OFF and unplug the power cord.
2. Remove fuse drawer, located on the AC power connector.
3. If either fuse is blown, replace both fuses.
4. Insert fuse drawer and reconnect power cord.

Scrubber Replacement

Use the following procedure to replace the ammonia scrubber ([Figure 7-17](#)).

Equipment Required:

Ammonia scrubber



Equipment Damage Some internal components can be damaged by small amounts of static electricity. A properly grounded antistatic wrist strap must be worn while handling any internal component. ▲

1. Turn instrument OFF, unplug the power cord, and remove the cover.
2. Unscrew the Teflon tubing at both ends of the scrubber.
3. Pull the scrubber off the mounting clips.
4. Push the replacement scrubber into the mounting clips.

5. Attach the Teflon tubing at both ends of the scrubber.
6. Replace the cover.

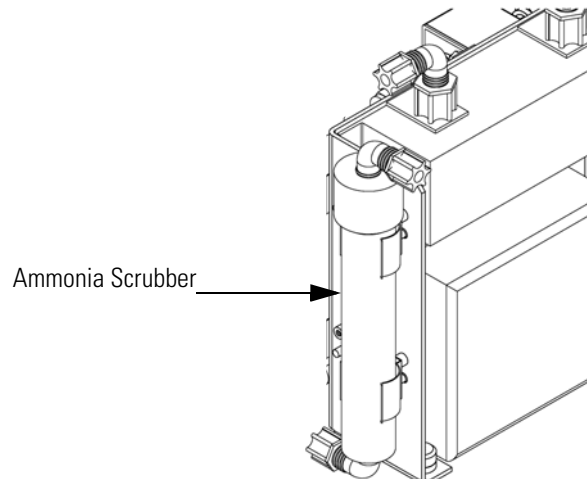

Figure 7-17. Replacing the Scrubber

I/O Expansion Board (Optional) Replacement

Use the following procedure to replace the optional I/O expansion board (Figure 7-18).

Equipment Required:

I/O expansion board

Nut driver, 3/16-inch



Equipment Damage Some internal components can be damaged by small amounts of static electricity. A properly grounded antistatic wrist strap must be worn while handling any internal component. ▲

1. Turn instrument OFF, unplug the power cord, and remove the cover.
2. Unplug the I/O expansion board cable from the EXPANSION BD connector on the motherboard.
3. Remove the standoffs holding the I/O expansion board connector to the rear panel (Figure 7-19).

Servicing

Digital Output Board Replacement

4. Pop off the board from the mounting studs and remove the board.
5. To install the I/O expansion board, follow previous steps in reverse.

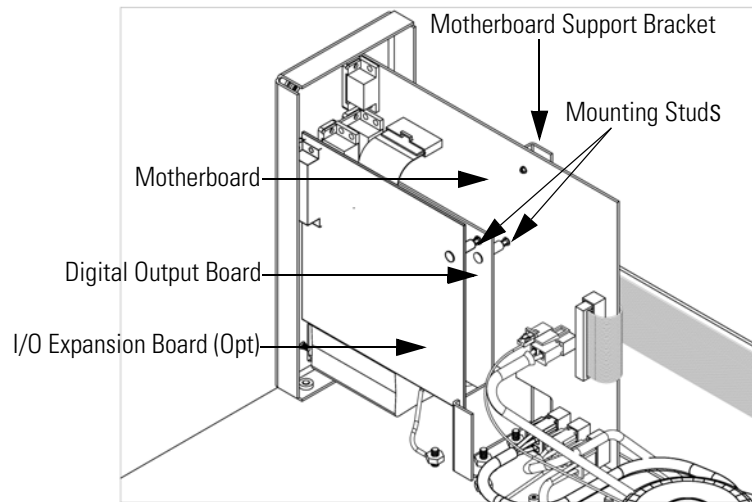

Figure 7-18. Replacing the I/O Expansion Board (Optional)

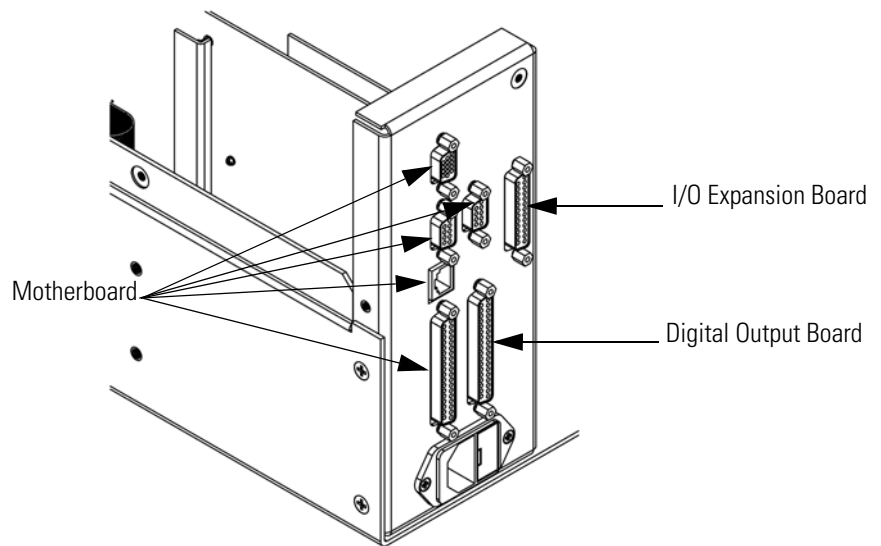

Figure 7-19. Rear Panel Board Connectors

Digital Output Board Replacement

Use the following procedure to replace the digital output board ([Figure 7-18](#)).

Equipment Required:

Digital output board

Nut driver, 3/16-inch



Equipment Damage Some internal components can be damaged by small amounts of static electricity. A properly grounded antistatic wrist strap must be worn while handling any internal component. ▲

1. Turn instrument OFF, unplug the power cord, and remove the cover.
2. Remove the I/O expansion board (optional), if used. See the “I/O Expansion Board Replacement” procedure in this chapter.
3. Disconnect the digital output board ribbon cable from the motherboard.
4. Using the nut driver, remove the standoffs securing the board to the rear panel (Figure 7-19).
5. Pop off the digital output board from the mounting studs and remove the board.
6. To install the digital output board, follow previous steps in reverse.

Motherboard Replacement

Use the following procedure to replace the motherboard (Figure 7-18).

Equipment Required:

Motherboard

Philips screwdriver

Nut driver, 3/16-inch



Equipment Damage Some internal components can be damaged by small amounts of static electricity. A properly grounded antistatic wrist strap must be worn while handling any internal component. ▲

1. Turn instrument OFF, unplug the power cord, and remove the cover.
2. Remove the I/O expansion board (optional), if used. See the “I/O Expansion Board Replacement” procedure in this chapter.
3. Remove the digital output board. See the “Digital Output Board Replacement” procedure in this chapter.
4. Unplug all connectors from the motherboard. Note connector locations to facilitate reconnection.
5. Using the nut driver, remove the standoffs securing the board to the rear panel.
6. Pop off the motherboard from motherboard support bracket, and remove the motherboard.
7. To install the motherboard, follow previous steps in reverse.

Measurement Interface Board Replacement

Use the following procedure to replace the measurement interface board (Figure 7-20).

Equipment Required:

Measurement interface board

Philips screwdriver



Equipment Damage Some internal components can be damaged by small amounts of static electricity. A properly grounded antistatic wrist strap must be worn while handling any internal component. ▲

1. Refer to “Removing the Measurement Bench and Lowering the Partition Panel” in this chapter to lower the partition panel, then proceed to the next step below.
2. Unplug all connectors. Note the locations of the connectors to facilitate reconnection.
3. Pop off the measurement interface board from the four mounting studs and remove the board.
4. To install the measurement interface board, follow previous steps in reverse.
5. Re-install the measurement bench. Refer to “Removing the Measurement Bench and Lowering the Partition Panel” in this chapter.

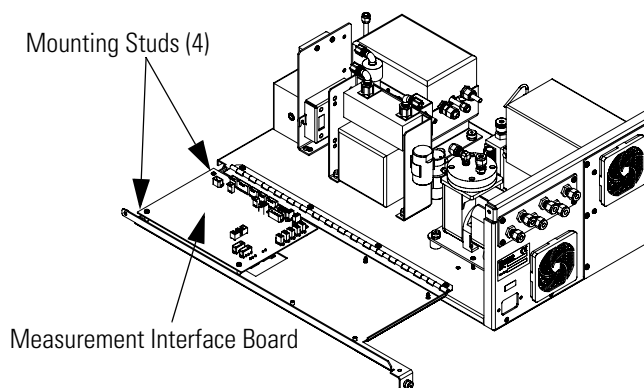

Figure 7-20. Replacing the Measurement Interface Board

Front Panel Board Replacement

Use the following procedure to replace the front panel board (Figure 7-21).

Equipment Required:

- Front panel board



Equipment Damage Some internal components can be damaged by small amounts of static electricity. A properly grounded antistatic wrist strap must be worn while handling any internal component. ▲

1. Turn instrument OFF, unplug the power cord, and remove the cover.

2. Remove the three ribbon cables and the two-wire connector from the front panel board.
3. Pop off the board from the two top mounting studs and remove the board by lifting it up and off the bottom support.
4. Replace the front panel board by following previous steps in reverse.

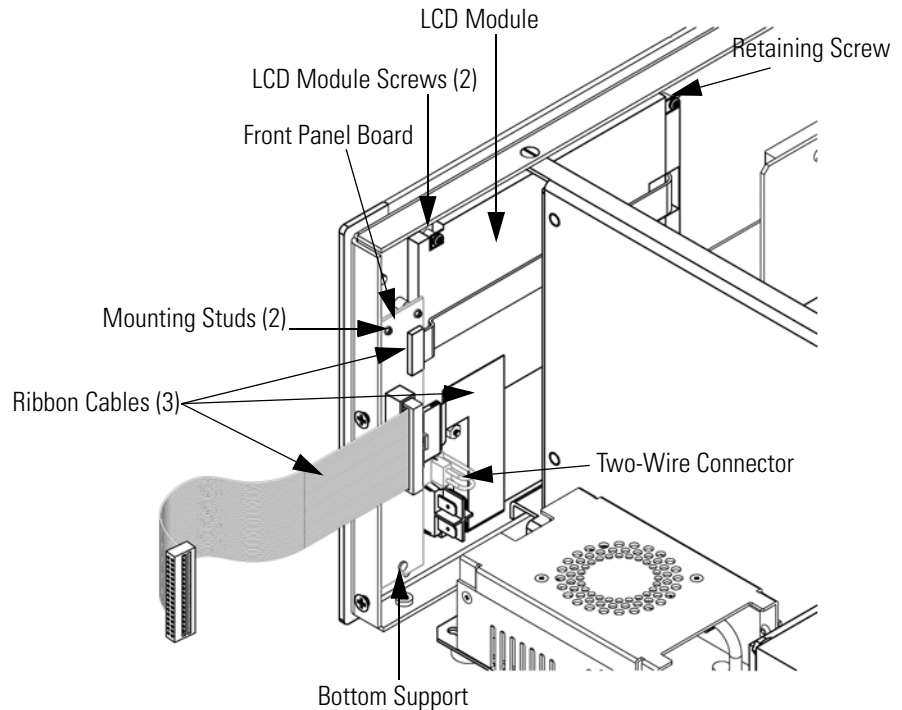

Figure 7-21. Replacing the Front Panel Board and the LCD Module

LCD Module Replacement

Use the following procedure to replace the LCD module (Figure 7-21).

Equipment Required:

LCD module

Philips screwdriver



CAUTION If the LCD panel breaks, do not let the liquid crystal contact your skin or clothes. If the liquid crystal contacts your skin or clothes, wash it off immediately using soap and water. ▲



Equipment Damage Some internal components can be damaged by small amounts of static electricity. A properly grounded antistatic wrist strap must be worn while handling any internal component. ▲

Do not remove the panel or frame from the module. ▲

The polarizing plate is very fragile, handle it carefully. ▲

Do not wipe the polarizing plate with a dry cloth, it may easily scratch the plate. ▲

Do not use alcohol, acetone, MEK or other Ketone based or aromatic solvents to clean the module, use a soft cloth moistened with a naphtha cleaning solvent. ▲

Do not place the module near organic solvents or corrosive gases. ▲

Do not shake or jolt the module. ▲

1. Turn instrument OFF, unplug the power cord, and remove the cover.
2. Remove the two screws from right side of LCD module (viewed front front).
3. Disconnect the ribbon cable and the two-wire connector from the front panel board.
4. Loosen left-side retaining screw (viewed from front) and slide the LCD module out towards the right and rear of the instrument.
5. Replace the LCD module by following previous steps in reverse.

Service Locations

For additional assistance, service is available from exclusive distributors worldwide. Contact one of the phone numbers below for product support and technical information or visit us on the web at www.thermo.com/aqi.

1-866-282-0430 Toll Free

1-508-520-0430 International

Chapter 8 System Description

This chapter describes the function and location of the system components, provides an overview of the software structure, and includes a description of the system electronics and input/output connections and functions.

- “Hardware” on page 8-1 describes the analyzer components.
- “Software” on page 8-4 provides an overview of the software organization and detailed information on the software tasks.
- “Electronics” on page 8-6 describes the system boards, assemblies, and connectors.
- “I/O Components” on page 8-9 describes the input and output communication functions and components.

Hardware

Hardware components (Figure 8-1) include:

- NO₂-to-NO converter
 - Mode solenoid
- Reaction chamber
 - Optical filter
 - Pressure transducer
- Ozonator
 - Ozone flow switch
- Photomultiplier tube
- Photomultiplier tube cooler
- Pump

- Sample capillary
- Dry air capillary

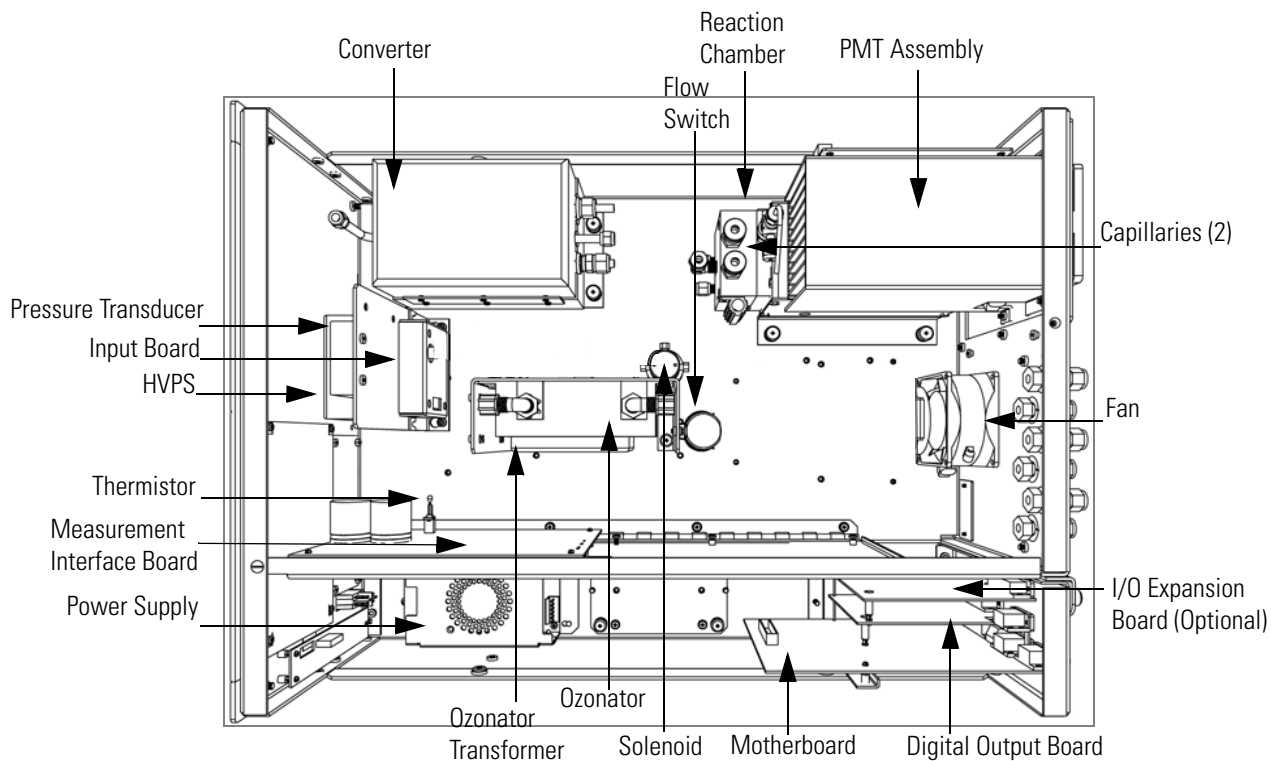

Figure 8-1. Hardware Components

NO₂-to-NO Converter

The NO₂-to-NO converter heats stainless steel to 625 °C in order to convert and detect NO₂. The converter consists of an insulated housing, heater, replaceable cartridge, and a type K thermocouple sensor.

Mode Solenoid

The mode solenoid valve switches analyzer operation between the NO mode and NO_x mode. It routes the ambient air sample either through the reaction chamber (NO mode) or through the NO₂-to-NO converter and then to the reaction chamber (NO_x mode).

Reaction Chamber

The reaction chamber is where the sample reacts with ozone and produces excited NO₂ that gives off a photon of energy when it decays.

The reaction chamber is heated and controlled to approximately 50 °C in order to ensure the greatest instrument stability. The sample and ozone flow capillaries and a thermistor sensor are also housed in/on the reaction chamber assembly.

Optical Filter

The optical filter housed in the reaction chamber limits the spectral region viewed by the detector and eliminates possible interferences due to other chemiluminescent reactions.

Pressure Transducer

The pressure transducer measures the reaction chamber pressure.

Ozonator

The ozonator generates the necessary ozone concentration required for the chemiluminescent reaction. The ozone reacts with the NO in the ambient air sample to produce the electronically excited NO₂ molecules.

Ozonator Flow Switch

The ozonator flow switch located at the ozonator inlet completes an electrical safety circuit when air flows through the sensor to the ozonator. If airflow stops, the flow sensor breaks the electrical circuit to the ozonator and shuts it off to prevent the ozonator from overheating.

Photomultiplier Tube

The photomultiplier tube (PMT) provides the infrared sensitivity required to detect the NO₂ luminescence resulting from the reaction of the ozone with the ambient air sample.

Optical energy from the reaction is converted to an electrical signal by the PMT and sent to the input board that transmits it to the processor.

Photomultiplier Tube Cooler

The thermoelectric PMT cooler reduces the PMT temperature to approximately -3 °C to minimize dark current and increase instrument sensitivity. The cooler helps to increase zero and span stability over a wide ambient temperature range. The cooler housing also shields the PMT from external electrical and optical interferences.

External Pump

The external vacuum pump draws the reacted gasses out of the reaction chamber.

Sample Capillary

The sample capillary along with the pump is used to control flow in the sample line.

Dry Air Capillary

The dry air capillary along with the pump is used to control flow in the dry air line.

Software

The processor software tasks are organized into four areas:

- Instrument Control
- Monitoring Signals
- Measurement Calculations
- Output Communications

Instrument Control

Low-level embedded processors are used to control the various functions on the boards, such as analog and digital I/O and heater control. These processors are controlled over a serial interface with a single high-level processor that also controls the front-panel user interface. The low-level processors all run a common piece of firmware that is bundled with the high-level firmware and loaded on power-up if a different version is detected.

Each board has a specific address that is used to identify to the firmware what functions are supported on that board. This address is also used for the communications between the low-level processors and the high-level processor.

Every tenth of a second the frequency counters, analog I/O, and digital I/O are read and written to by the low-level processor. The counters are accumulated over the past second and the analog inputs are averaged over that second. The high-level processor polls the low-level processors once per second to exchange the measurement and control data.

Monitoring Signals

Signals are gathered from the low-level processors once per second, and then processed by the high-level processor to produce the final measurement values. The one-second accumulated counts representing the NO/NO_x are accumulated and reported for the user-specified averaging time. If this averaging time is greater than ten seconds, the measurement is reported every 10 seconds. The one-second average of the other analog inputs are reported directly (no additional signal conditioning is performed by the high-level processor).

In auto mode, every ten seconds the NO/NO_x solenoid switches and the processor waits three seconds for the reaction chamber to flush and stabilize. After those three seconds, it accumulates the signal counts for seven seconds before again switching the solenoid.

Measurement Calculations

The calculation of the NO and NO_x concentrations is lengthy and uses the high-level processor to provide the most accurate readings. The calculation begins by subtracting the appropriate electronic offset from the seven-second count accumulation. Following this correction, the raw accumulated counts are scaled according to the gain setting of the input board.

Next, the uncorrected NO and NO_x values are determined according to a unique averaging algorithm which minimizes errors resulting from rapidly changing gas concentrations. This algorithm results in NO and NO_x values which are stored in RAM in a circular buffer that holds all the ten second data from the previous five minutes. This data is averaged over the selected time interval, which can be any multiple of ten between 10 and 300 (the manual modes have additional intervals of 1, 2, and 5 seconds).

The background values for NO and NO_x, which are corrected for temperature, are subtracted from their respective averages. The NO reading is corrected by the stored span factor and by the temperature factor. The NO_x reading is partially corrected by the span factor, temperature factor, and balance factor. The corrected NO value is subtracted from the partially corrected NO_x value to yield an uncorrected NO₂ value. The NO₂ value is then corrected for converter efficiency to give a corrected NO₂ reading. Finally, the corrected NO₂ reading is added to the corrected NO reading to yield a fully corrected NO_x value.

Output Communication

The front panel display, serial and Ethernet data ports, and analog outputs are the means of communicating the results of the above calculations. The front panel display presents the NO, NO₂, and NO_x concentrations simultaneously. The display is updated every 1-10 seconds, depending on the averaging time.

The analog output ranges are user selectable via software. The analog outputs are defaulted based on the measurement range. The defaults are calculated by dividing the data values by the full-scale range for each of the three parameters and then multiplying each result by the user-selected output range. Negative concentrations can be represented as long as they are within -5% of full-scale. The zero and span values may be set by the user to any desired value.

Electronics

All electronics operate from a universal switching supply, which is capable of auto-sensing the input voltage and working over the entire operating range.

Internal pumps and heaters all operate on 110VAC. An optional transformer is required if operating on the 210-250VAC or 90-110VAC ranges.

An on/off switch controls all power to the instrument, and is accessible on the front panel.

Motherboard

The motherboard contains the main processor, power supplies, a sub-processor and serves as the communication hub for the instrument. The motherboard receives operator inputs from the front panel mounted function key panel and/or over I/O connections on the rear panel and sends commands to the other boards to control the functions of the instrument and to collect measurement and diagnostic information. The motherboard outputs instrument status and measurement data to the front-panel mounted graphics display and to the rear-panel I/O. The motherboard also contains I/O circuitry and the associated connector to monitor external digital status lines and to output analog voltages that represent the measurement data. Connectors located on the motherboard include:

External Connectors

External connectors include:

- External Accessory
- RS-232/485 Communications (two connectors)
- Ethernet Communications
- I/O connector with Power Fail Relay, 16 Digital Inputs, and 6 Analog Voltage Outputs.

Internal Connectors

Internal connectors include:

- Function key panel and Display
- Measurement Interface Board Data
- I/O Expansion Board Data
- Digital Output Board

- AC distribution

Measurement Interface Board

The measurement interface board serves as a central connection area for all measurement electronics in the instrument. It contains power supplies and interface circuitry for sensors and control devices in the measurement system. It sends status data to the motherboard and receives control signals from the motherboard.

Measurement Interface Board Connectors

Connectors located on the measurement interface board include:

- Data communication with the motherboard
- 24V and 120VAC power supply inputs
- Fans and solenoid outputs
- Cooler control
- 120VAC outputs for the pump and temperature control board
- Ozonator
- Pressure sensor
- Ambient temperature sensor
- Temperature control board
- PMT high voltage supply
- Measurement input board
- Permeation oven option

Pressure Sensor Assembly

The pressure sensor assembly consists of a board containing an instrumentation amplifier and a pressure transducer with a gas input fitting. The pressure transducer output is produced by measuring the pressure difference between the sample gas pressure and ambient air pressure.

Temperature Control Board

The temperature control board regulates and sets the temperature of the reaction chamber and converter.

The reaction chamber temperature is measured with a thermistor. The voltage across the thermistor is fed to the main processor for use in calculating and displaying the reaction chamber temperature. The voltage across the thermistor is also compared to a set-point voltage and used to control that the reaction chamber heaters to maintain a constant temperature of 50 °C. Protective circuitry prevents over heating in the event of broken wires to the thermistor.

The converter temperature is measured by a conditioned thermocouple signal and fed back to the main processor to be used to display and control the converter temperature. The temperature control board receives control signals from the main processor software to control the converter heater to the desired set point. Protective circuitry prevents over heating in the event of broken wires to the thermocouple or processor faults.

PMT Power Supply Assembly

The PMT power supply produces high voltage to operate the photo multiplier tube used in the measurement system. The output voltage is adjustable from approximately 600 to 1200 volts under software control.

Input Board Assembly

The input board accepts the current signal from the PMT and converts it to a voltage, which is scaled by a factor of approximately 1, 10, or 100 depending on the full-scale range of the NO channel. The scaled voltage signal is converted to a frequency and sent to the microprocessor.

The input board includes a test signal that can be activated under software control. The test signal is injected at the first stage of the input board in parallel with the PMT input. This allows the input board and the connection to the processor system to be tested and calibrated without using the PMT.

Digital Output Board

The digital output board connects to the motherboard and provides solenoid driver outputs and relay contact outputs to a connector located on the rear panel of the instrument. Ten relay contacts normally open (with power off) are provided which are electrically isolated from each other. Eight solenoid driver outputs (open collector) are provided along with a corresponding +24VDC supply pin on the connector.

I/O Expansion Board (Optional)

The I/O expansion board connects to the motherboard and adds the capability to input external analog voltage inputs and to output analog currents via a connector located on the rear panel of the instrument. It contains local power supplies, a DC/DC isolator supply, a sub-processor and

analog circuits. Eight analog voltage inputs are provided with an input voltage range of 0V to 10VDC. Six current outputs are provided with a normal operating range of 0 to 20 mA.

Front Panel Connector Board

The front panel connector board interfaces between the motherboard and the front panel mounted function key panel and Graphics display. It serves as central location to tie the three connectors required for the function key panel, the graphics display control lines, and the graphics display backlight to a single ribbon cable extending back to the motherboard. This board also includes signal buffers for the graphics display control signals and a high voltage power supply for the graphics display backlight.

I/O Components

External I/O is driven from a generic bus that is capable of controlling the following devices:

- Analog output (voltage and current)
- Analog input (voltage)
- Digital output (TTL levels)
- Digital input (TTL levels)

Note The instrument has spare solenoid valve drivers and I/O support for future expansion. ▲

Analog Voltage Outputs

The instrument provides six analog voltage outputs. Each may be software configured for any one of the following ranges, while maintaining a minimum resolution of 12 bits:

- 0-100mV
- 0-1V
- 0-5V
- 0-10V

The user can calibrate each analog output zero and span point through firmware. At least 5% of full-scale over and under range are also supported.

The analog outputs may be assigned to any measurement or diagnostic channel with a user-defined range in the units of the selected parameter. The voltage outputs are independent of the current outputs.

Analog Current Outputs (Optional)

The optional I/O Expansion board includes six isolated current outputs. These are software configured for any one of the following ranges, while maintaining a minimum resolution of 11 bits:

- 0-20 mA
- 4-20 mA

The user can calibrate each analog output zero and span point through firmware. At least 5% of full-scale over and under range are also supported.

The analog outputs may be assigned to any measurement or diagnostic channel with a user-defined range in the units of the selected parameter. The current outputs are independent of the voltage outputs. The current outputs are isolated from the instrument power and ground, but they share a common return line (Isolated GND).

Analog Voltage Inputs (Optional)

The optional I/O expansion board includes eight analog voltage inputs. These inputs are used to gather measurement data from third-party devices such as meteorological equipment. The user may assign a label, unit, and a voltage to user-defined unit conversion table (up to 16 points). All voltage inputs have a resolution of 12 bits over the range of 0 to 10 volts.

Digital Relay Outputs

The instrument includes one power fail relay on motherboard and ten digital output relays on the digital output board. These are reed relays rated for at least 500 mA @ 200VDC.

The power fail relay is Form C (both normally opened and normally closed contacts). All other relays are Form A (normally opened contacts) and are used to provide alarm status and mode information from the analyzer, as well as remote control to other devices, such as for controlling valves during calibration. The user may select what information is sent out each relay and whether the active state is opened or closed.

Digital Inputs

Sixteen digital inputs are available which may be programmed to signal instrument modes and special conditions including:

- NO Measure Mode

- NO_x Measure Mode
- Zero Gas Mode
- Span Gas Mode

The actual use of these inputs will vary based on analyzer configuration.

The digital inputs are TTL level compatible and are pulled up within the analyzer. The active state can be user defined in firmware.

Serial Ports

Two serial ports allow daisy chaining so that multiple analyzers may be linked using one PC serial port.

The standard bi-directional serial interface can be configured for either RS-232 or RS-485. The serial baud rate is user selectable in firmware for standard speeds from 1200 to 19,200 baud. The user can also set the data bits, parity, and stop bits. The following protocols are supported:

- C-Link
- Streaming Data
- Modbus Slave

The Streaming Data protocol transmits user-selected measurement data via the serial port in real-time for capture by a serial printer, data logger, or PC.

RS-232 Connection

A null modem (crossed) cable is required when connecting the analyzer to an IBM Compatible PC. However, a straight cable (one to one) may be required when connecting the analyzer to other remote devices. As a general rule, when the connector of the host remote device is female, a straight cable is required and when the connector is male, a null modem cable is required.

Data Format:

1200, 2400, 4800, 9600, 19200, 38400, 57600, or 115200 BAUD

8 data bits

1 stop bit

no parity

All responses are terminated with a carriage return (hex 0D)

Refer to [Table 8-1](#) for the DB9 connector pin configuration.

Table 8-1. RS-232 DB Connector Pin Configurations

DB9 Pin	Function
2	RX
3	TX
7	RTS
8	CTS
5	Ground

RS-485 Connection

The instrument uses a four wire RS-485 configuration with automatic flow control (SD). Refer to [Table 8-2](#) for the DB9 connector pin configuration.

Table 8-2. RS-485 DB Connector Pin Configuration

DB9 Pin	Function
2	+ receive
8	- receive
7	+ transmit
3	- transmit
5	ground

Ethernet Connection

An RJ45 connector is used for the 10Mbps Ethernet connection supporting TCP/IP communications via standard IPV4 addressing. The IP address may be configured for static addressing or dynamic addressing (set using a DHCP server).

Any serial port protocols may be accessed over Ethernet in addition to the serial port.

External Accessory Connector

The external accessory connector is not used.

Note This port is used in other models to communicate with smart external devices that may be mounted hundreds of feet from the analyzer using an RS-485 electrical interface. ▲

Chapter 9 Optional Equipment

The Model 42i High Level is available with the following options:

- “Internal Zero/Span Assembly” on page 9-1
- “Bypass Flow” on page 9-3
- “Ammonia Scrubber” on page 9-3
- “Teflon Particulate Filter” on page 9-4
- “Ozone Particulate Filter” on page 9-4
- “NO₂-to-NO Converter” on page 9-4
- “I/O Expansion Board Assembly” on page 9-4
- “Terminal Block and Cable Kits” on page 9-4
- “Mounting Options” on page 9-5

Internal Zero/Span Assembly

With the internal zero/span assembly option, a source of span gas is connected to the SPAN port and a source of zero air is connected to the ZERO port as shown in [Figure 9-1](#). Zero and span gas should be supplied at atmospheric pressure. It may be necessary to use an atmospheric dump bypass plumbing arrangement to accomplish this. Refer to “Setup Procedure” in the “Installation” chapter for an illustration of an atmospheric dump bypass arrangement.

For more information, refer to the “Installation” chapter. If this option is installed, refer to the “Operation” chapter for more information.

Optional Equipment
Internal Zero/Span Assembly

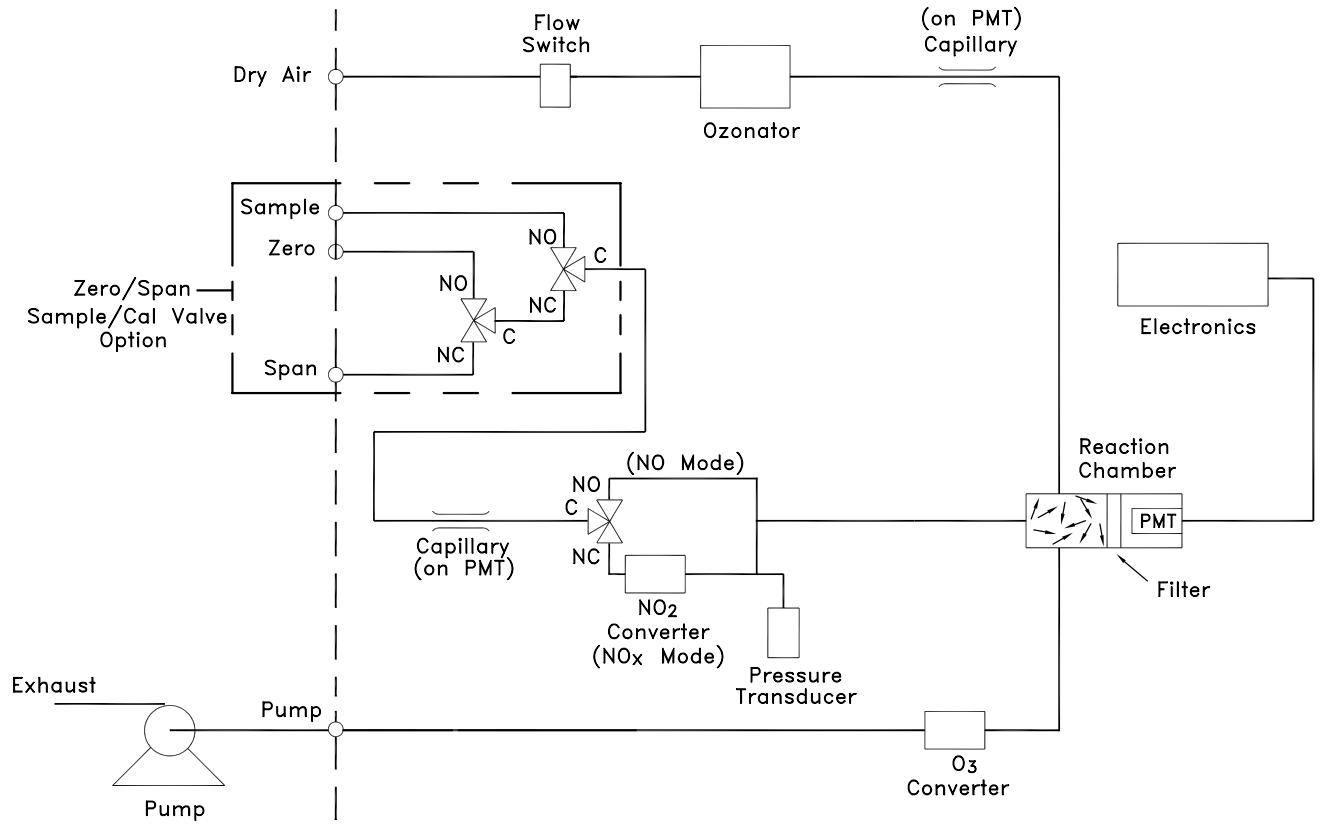

Figure 9-1. Zero/Span Option Flow Diagram

Bypass Flow

The regulated bypass flow system is used when the sample must be transported over a long distance. It is also used when an unstable flow is being provided. The regulated bypass flow system provides make-up air through the sample regulator and eliminates instrument drift due to pressure changes.

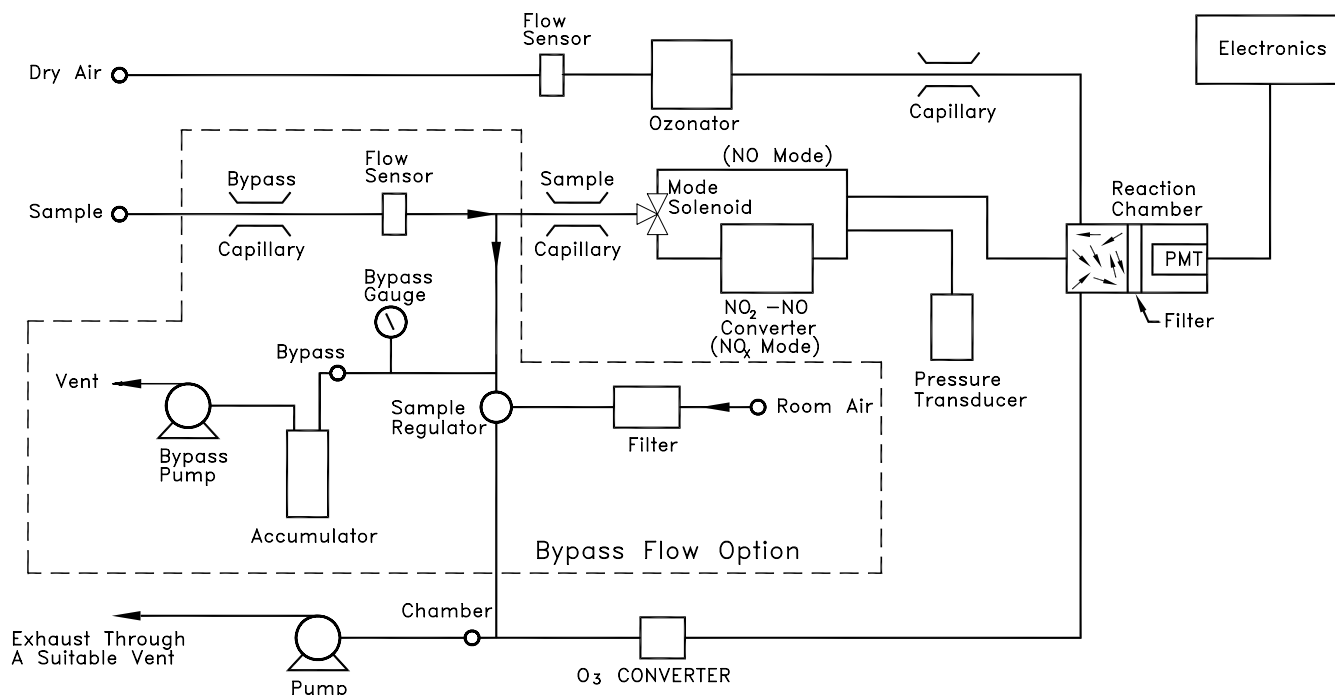

Figure 9-2. Bypass Flow Option Flow Schematic

Permeation Dryer Assembly

The permeation dryer minimizes routine maintenance procedures by providing a continuous stream of dry air to the ozonator (using the selective water permeation characteristics of the dryer). With the permeation dryer option, it is not necessary to constantly replenish the ozonator air-drying column as in the standard instrument.

Refer to the “Operation” chapter for more information.

Ammonia Scrubber

The ammonia scrubber is mounted internally and removes ammonia from the sample air.

Teflon Particulate Filter

A 5-10 micron pore size, two-inch diameter Teflon® element is available for the Model 42i High Level. This filter should be installed just prior to the SAMPLE bulkhead. When using a filter, all calibrations and span checks must be performed through the filter.

Ozone Particulate Filter

The ozone particulate filter minimizes the potential for contamination of the ozonator by trapping any particulate matter before passing through the ozonator.

NO₂-to-NO Converter

The Model 42i High Level includes a stainless steel NO₂-to-NO converter as standard equipment.

I/O Expansion Board Assembly

For a detailed description, refer to the “System Description” chapter.

Terminal Block and Cable Kits

The terminal block and cable kit provides a convenient way to connect devices to the analyzer. The kit breaks out the signals on the rear panel connector to individual numbered terminals.

Two types of terminal block and cable kits are available. One kit is for the DB37 connectors and can be used for either the analog output connector or the relay output connector. The other kit is for the DB25 connector and can be used for the optional I/O expansion board. The parts available in these kits can also be purchased separately.

Each kit consists of:

- one six-foot cable
- one terminal block
- one snap track

Note Supporting all of the connections on units with the optional I/O expansion board requires:

two DB37 kits

one DB25 kit

Mounting Options

The analyzer can be installed in the configurations described in [Table 9-1](#) and shown in [Figure 9-3](#) through [Figure 9-6](#).

Table 9-1. Mounting Options

Mounting Type	Description
Bench	Positioned on bench, includes mounting feet, and front panel side-trim ears.
EIA rack	Mounted in an EIA-style rack, includes mounting slides, and front panel EIA-rack mounting ears.
Retrofit rack	Mounted in a Thermo non-EIA rack, includes mounting slides, and retrofit front panel rack-mounting ears.

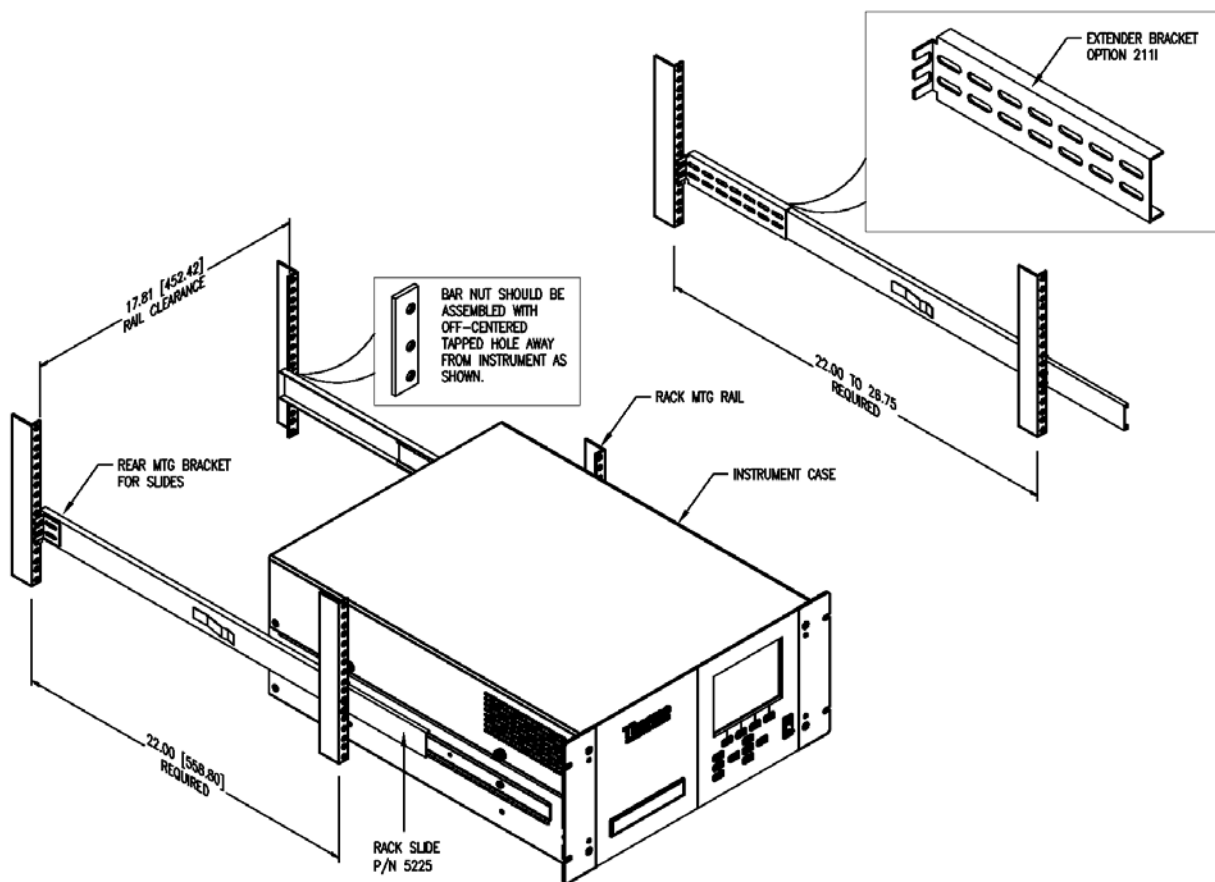

Figure 9-3. Rack Mount Option Assembly

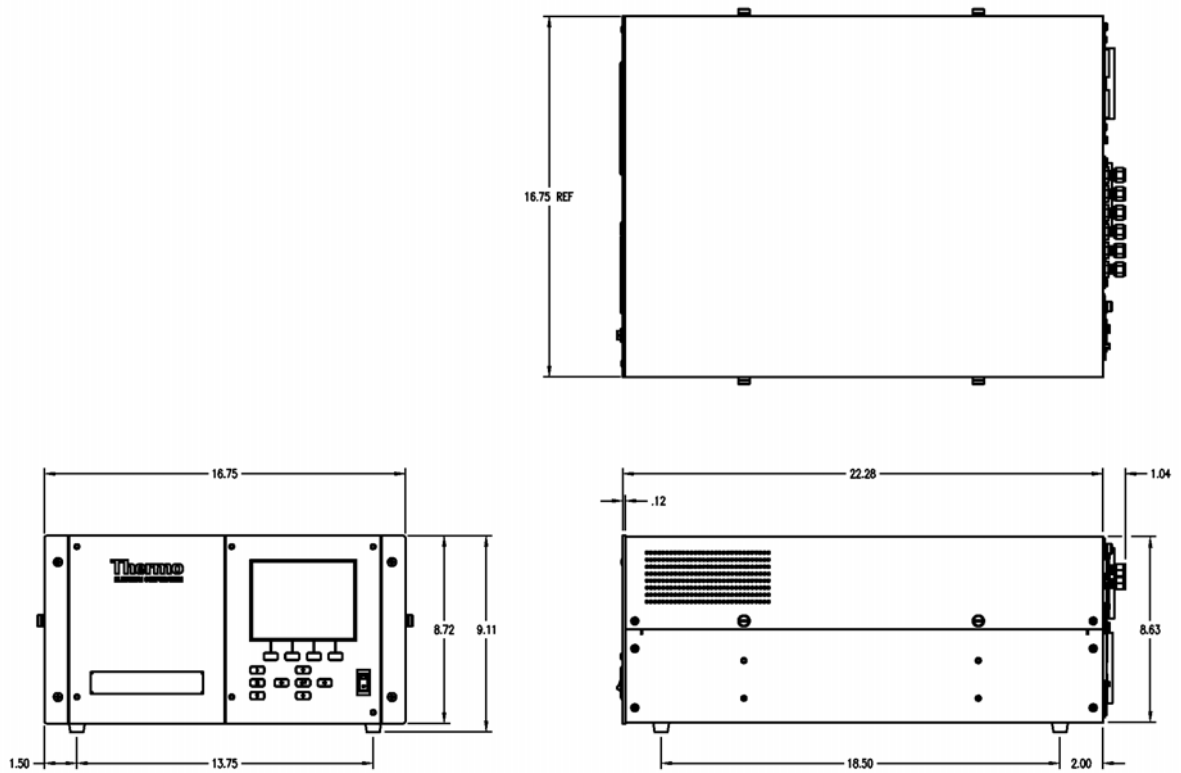

Figure 9-4. Bench Mounting

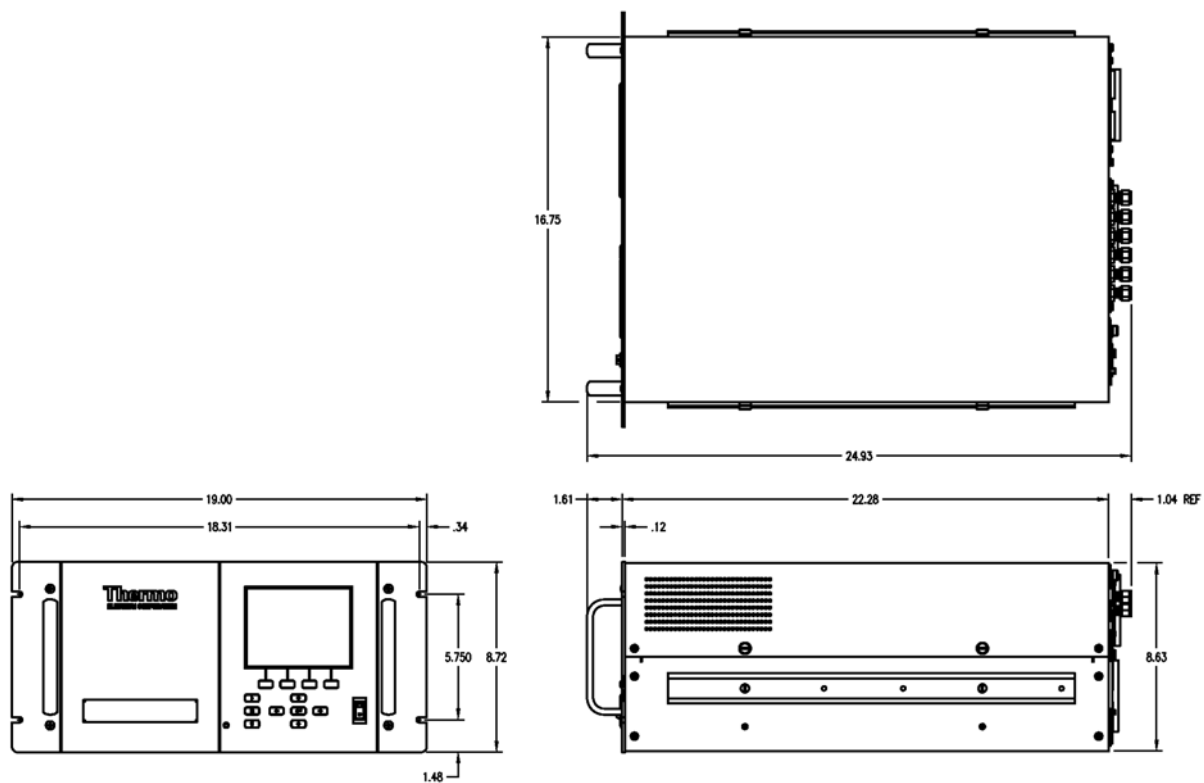

Figure 9-5. EIA Rack Mounting

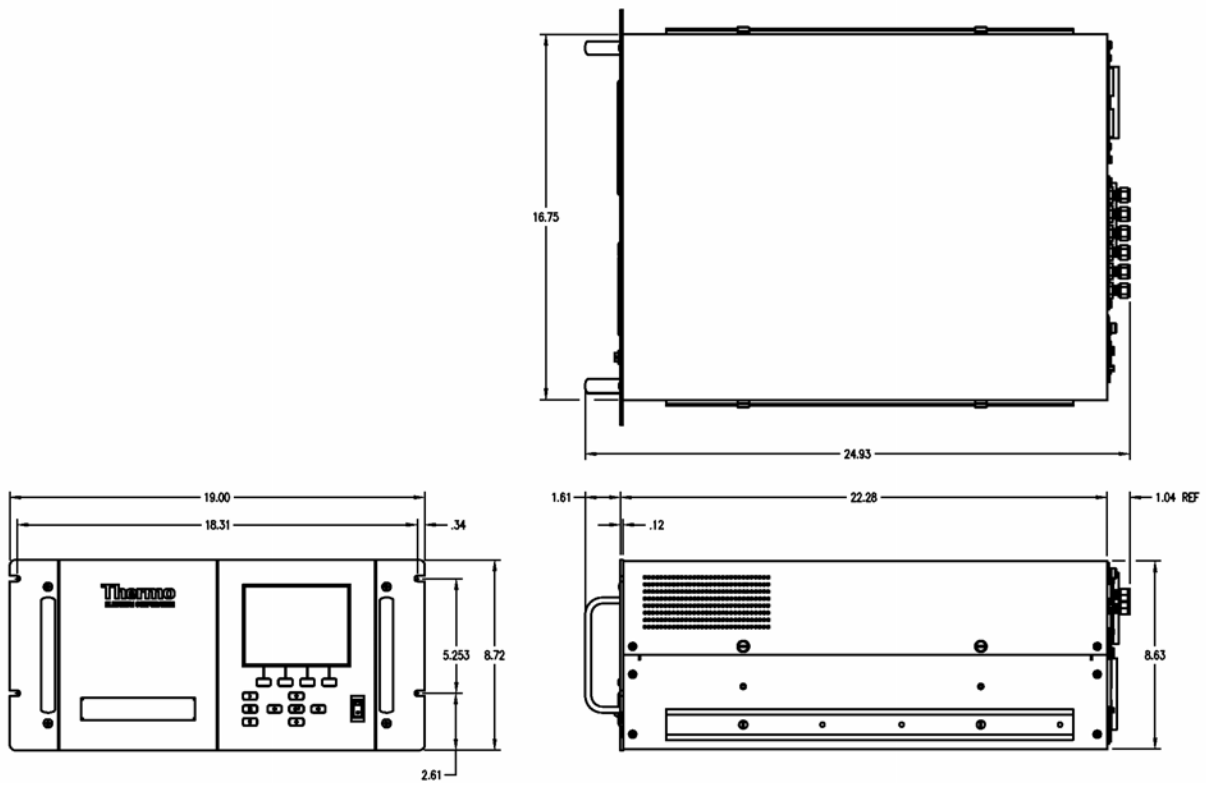

Figure 9-6. Retrofit Rack Mounting

Appendix A Warranty

Seller warrants that the Products will operate or perform substantially in conformance with Seller's published specifications and be free from defects in material and workmanship, when subjected to normal, proper and intended usage by properly trained personnel, for the period of time set forth in the product documentation, published specifications or package inserts. If a period of time is not specified in Seller's product documentation, published specifications or package inserts, the warranty period shall be one (1) year from the date of shipment to Buyer for equipment and ninety (90) days for all other products (the "Warranty Period"). Seller agrees during the Warranty Period, to repair or replace, at Seller's option, defective Products so as to cause the same to operate in substantial conformance with said published specifications; provided that (a) Buyer shall promptly notify Seller in writing upon the discovery of any defect, which notice shall include the product model and serial number (if applicable) and details of the warranty claim; (b) after Seller's review, Seller will provide Buyer with service data and/or a Return Material Authorization ("RMA"), which may include biohazard decontamination procedures and other product-specific handling instructions; and (c) then, if applicable, Buyer may return the defective Products to Seller with all costs prepaid by Buyer. Replacement parts may be new or refurbished, at the election of Seller. All replaced parts shall become the property of Seller. Shipment to Buyer of repaired or replacement Products shall be made in accordance with the Delivery provisions of the Seller's Terms and Conditions of Sale. Consumables, including but not limited to lamps, fuses, batteries, bulbs and other such expendable items, are expressly excluded from the warranty under this warranty.

Notwithstanding the foregoing, Products supplied by Seller that are obtained by Seller from an original manufacturer or third party supplier are not warranted by Seller, but Seller agrees to assign to Buyer any warranty rights in such Product that Seller may have from the original manufacturer or third party supplier, to the extent such assignment is allowed by such original manufacturer or third party supplier.

In no event shall Seller have any obligation to make repairs, replacements or corrections required, in whole or in part, as the result of (i) normal wear and tear, (ii) accident, disaster or event of force majeure, (iii) misuse, fault or negligence of or by Buyer, (iv) use of the Products in a manner for which they were not designed, (v) causes external to the Products such as, but not

limited to, power failure or electrical power surges, (vi) improper storage and handling of the Products or (vii) use of the Products in combination with equipment or software not supplied by Seller. If Seller determines that Products for which Buyer has requested warranty services are not covered by the warranty hereunder, Buyer shall pay or reimburse Seller for all costs of investigating and responding to such request at Seller's then prevailing time and materials rates. If Seller provides repair services or replacement parts that are not covered by the warranty provided in this warranty, Buyer shall pay Seller therefor at Seller's then prevailing time and materials rates. ANY INSTALLATION, MAINTENANCE, REPAIR, SERVICE, RELOCATION OR ALTERATION TO OR OF, OR OTHER TAMPERING WITH, THE PRODUCTS PERFORMED BY ANY PERSON OR ENTITY OTHER THAN SELLER WITHOUT SELLER'S PRIOR WRITTEN APPROVAL, OR ANY USE OF REPLACEMENT PARTS NOT SUPPLIED BY SELLER, SHALL IMMEDIATELY VOID AND CANCEL ALL WARRANTIES WITH RESPECT TO THE AFFECTED PRODUCTS.

THE OBLIGATIONS CREATED BY THIS WARRANTY STATEMENT TO REPAIR OR REPLACE A DEFECTIVE PRODUCT SHALL BE THE SOLE REMEDY OF BUYER IN THE EVENT OF A DEFECTIVE PRODUCT. EXCEPT AS EXPRESSLY PROVIDED IN THIS WARRANTY STATEMENT, SELLER DISCLAIMS ALL OTHER WARRANTIES, WHETHER EXPRESS OR IMPLIED, ORAL OR WRITTEN, WITH RESPECT TO THE PRODUCTS, INCLUDING WITHOUT LIMITATION ALL IMPLIED WARRANTIES OF MERCHANTABILITY OR FITNESS FOR ANY PARTICULAR PURPOSE. SELLER DOES NOT WARRANT THAT THE PRODUCTS ARE ERROR-FREE OR WILL ACCOMPLISH ANY PARTICULAR RESULT.

Appendix B C-Link Protocol Commands

This appendix provides a description of the C-Link protocol commands that can be used to remotely control a Model 42*i* High Level analyzer using a host device such as a PC or a datalogger. C-Link protocol may be used over RS-232, RS-485, or Ethernet. C-Link functions can be accessed over Ethernet using TCP/IP port 9880.

- “Instrument Identification Number” on page B-2 describes the C-Link command format.
- “Commands” on page B-2 lists all the 42*i* High Level C-Link commands in Table B-1.
- “Measurements” on page B-9 describes and gives examples of the measurement commands.
- “Alarms” on page B-12 describes and gives examples of the alarm commands.
- “Diagnostics” on page B-16 describes and gives examples of the diagnostic commands.
- “Datalogging” on page B-17 describes and gives examples of the datalogging commands.
- “Calibration” on page B-24 describes and gives examples of the calibration commands.
- “Keys/Display” on page B-27 describes and gives examples of the keys and display commands.
- “Measurement Configuration” on page B-29 describes and gives examples of the measurement configuration commands.
- “Hardware Configuration” on page B-32 describes and gives examples of the hardware commands.
- “Communications Configuration” on page B-36 describes and gives examples of the communication commands.

- “I/O Configuration” on page B-40 describes and gives examples of the I/O commands.
- “Record Layout Definition” on page B-44 describes and gives examples of the record layouts.

Instrument Identification Number

Each command sent to the analyzer must begin with the American Standard Code for Information Interchange (ASCII) symbol or byte value equivalent of the instrument's identification number plus 128. For example, if the instrument ID is set to 25, then each command must begin with the ASCII character code 153 decimal. The analyzer ignores any command that does not begin with its instrument identification number. If the instrument ID is set to 0, then this byte is not required. For more information on changing Instrument ID, see Chapter 3, “Operation”.

Commands

The analyzer must be in the remote mode in order to change instrument parameters via remote. However, the command “set mode remote” can be sent to the analyzer to put it in the remote mode. Report commands (commands that don't begin with “set”) can be issued either in the remote or local mode. For information on changing modes, see Chapter 3, “Operation.”

The commands can be sent in either uppercase or lowercase characters. Each command must begin with the proper instrument identification number (ASCII) character. The command in the example below begins with the ASCII character code 170 decimal, which directs the command to the Model 42i, High Level and is terminated by a carriage return “CR” (ASCII character code 13 decimal).

<ASCII 170>	T	I	M	E	<CR>
-------------	---	---	---	---	------

If an incorrect command is sent, a “bad command” message will be received. The example below sends the incorrect command “set unit ppm” instead of the correct command “set gas unit ppm.”

```
Send:      set unit ppm
Receive:   set unit ppm bad cmd
```

The “save” and “set save params” commands stores parameters in FLASH. It is important that each time instrument parameters are changed, that this command be sent. If changes are not saved, they will be lost in the event of a power failure.

Table B-1 lists the 42i High Level C-Link protocol commands. The interface will respond to the command strings outlined below.

Table B-1. C-Link Protocol Commands

Command	Description	Page
addr dns	Reports/sets domain name server address	B-36
addr gw	Reports/sets default gateway address	B-36
addr ip	Reports/sets IP address	B-36
addr nm	Reports/sets netmask address	B-37
alarm chamber temp max	Reports/sets chamber temperature alarm maximum value	B-12
alarm chamber temp min	Reports/sets chamber temperature alarm minimum value	B-12
alarm conc no max	Reports/sets current NO concentration alarm maximum value	B-13
alarm conc no min	Reports/sets current NO concentration alarm minimum value	B-13
alarm conc no2 min	Reports/sets current NO ₂ concentration alarm maximum value	B-13
alarm conc no2 max	Reports/sets current NO ₂ concentration alarm minimum value	B-13
alarm conc nox max	Reports/sets current NO _x concentration alarm minimum value	B-13
alarm conc nox min	Reports/sets current NO _x concentration alarm maximum value	B-13
alarm converter temp max	Reports/sets NO ₂ converter temperature alarm maximum value	B-13
alarm converter temp min	Reports/sets NO ₂ converter temperature alarm minimum value	B-14
alarm cooler temp max	Reports/sets PMT cooler temperature alarm maximum value	B-13
alarm cooler temp min	Reports/sets PMT cooler temperature alarm minimum value	B-14
alarm internal temp max	Reports/sets internal temperature alarm maximum value	B-14
alarm internal temp min	Reports/sets internal temperature alarm minimum value	B-14
alarm pressure max	Reports/sets pressure alarm maximum value	B-14
alarm pressure min	Reports/sets pressure alarm minimum value	B-14
alarm sample flow max	Reports/sets sample flow (or bypass flow if installed) alarm maximum value	B-15
alarm sample flow min	Reports/sets sample flow (or bypass flow if installed) alarm minimum value	B-15
alarm trig conc no	Reports/sets current NO concentration alarm warning value	B-15
alarm trig conc no2	Reports/sets current NO ₂ concentration alarm warning value	B-15
alarm trig conc nox	Reports/sets current NO _x concentration alarm warning value	B-15

Table B-1. C-Link Protocol Commands, continued

Command	Description	Page
analog iout range	Reports analog current output range per channel	B-40
analog vin	Retrieves analog voltage input data per channel	B-40
analog vout range	Reports analog voltage output range per channel	B-41
avg time	Reports/sets averaging time	B-9
baud	Reports/sets current baud rate	B-37
cal high no coef	Sets/auto-calibrates high range NO coefficient	B-24
cal high no2 coef	Sets/auto-calibrates high range NO ₂ coefficient	B-24
cal high nox coef	Sets/auto-calibrates high range NO _x coefficient	B-24
cal low no coef	Sets/auto-calibrates low range NO coefficient	B-24
cal low no2 coef	Sets/auto-calibrates low range NO ₂ coefficient	B-24
cal low nox coef	Sets/auto-calibrates low range NO _x coefficient	B-24
cal no bkg	Sets/auto-calibrates NO background	B-24
cal no coef	Sets/auto-calibrates NO coefficient	B-24
cal no2 coef	Sets/auto-calibrates NO ₂ coefficient	B-24
cal nox bkg	Sets/auto-calibrates NO _x background	B-24
cal nox coef	Sets/auto-calibrates NO _x coefficient	B-24
cal pres	Sets current measured pressure as pressure during calibration (for pressure compensation)	B-27
clr lrecs	Clears away only long records that have been saved	B-17
clr records	Clears away all logging records that have been saved	B-17
clr srecs	Clears away only short records that have been saved	B-17
contrast	Reports/sets current screen contrast	B-32
conv set temp	Reports/sets temperature setpoint for NO ₂ converter	B-33
conv temp	Reports current NO ₂ converter temperature	B-10
cooler temp	Reports temperature of PMT cooler (same as PMT temperature)	B-10
copy lrec to sp	Sets/copies current lrec selection into the scratch pad	B-22
copy sp to lrec	Sets/copies current selections in scratch pad into lrec list	B-22
copy sp to srec	Sets/copies current selections in scratch pad into srec list	B-22
copy sp to stream	Sets/copies current selections in scratch pad into stream list	B-22
copy srec to sp	Sets/copies current srec selection into the scratch pad	B-22
copy stream to sp	Sets/copies current streaming data selection into the scratch pad	B-22
custom	Reports/sets defined custom range concentration	B-30
date	Reports/sets current date	B-33

Table B-1. C-Link Protocol Commands, continued

Command	Description	Page
default params	Sets parameters to default values	B-34
dhcp	Reports/sets state of use of DHCP	B-37
diag volt iob	Reports diagnostic voltage level for I/O expansion board	B-16
diag volt mb	Reports diagnostic voltage level for motherboard	B-16
diag volt mib	Reports diagnostic voltage level for measurement interface board	B-16
dig in	Reports status of the digital inputs	B-41
din	Reports/sets digital input channel and active state	B-41
do (down)	Simulates pressing down pushbutton	B-27
dout	Reports/sets digital output channel and active state	B-42
dtoa	Reports outputs of the digital to analog converters per channel	B-42
en (enter)	Simulates pressing enter pushbutton	B-27
er	Returns a brief description of the main operating conditions in the format specified in the commands	B-18
erec	Returns a brief description of the main operating conditions in the format specified in the command	B-18
erec format	Reports/sets erec format (ASCII or binary)	B-20
erec layout	Reports current layout of erec data	B-20
flags	Reports 8 hexadecimal digits (or flags) that represent the status of the ozonator, PMT, gas mode, and alarms	B-11
flow	Reports current measured flow	B-10
format	Reports/sets current reply termination format	B-38
gas mode	Reports current mode of sample, zero, or span	B-31
gas unit	Reports/sets current gas units	B-31
he (help)	Simulates pressing help pushbutton	B-27
high avg time	Reports/sets high range averaging time	B-9
high no	Reports NO concentration calculated with high range coefficients	B-10
high no coef	Reports/sets high range NO coefficients	B-25
high no gas	Reports/sets high range NO span gas concentration	B-25
high no2	Reports NO ₂ concentration calculated with high range coefficients	B-10
high no2 coef	Reports/sets high range NO ₂ coefficients	B-25
high no2 gas	Reports/sets high range NO ₂ span gas concentration	B-25
high nox	Reports NO _x concentration calculated with high range coefficients	B-10

Table B-1. C-Link Protocol Commands, continued

Command	Description	Page
high nox coef	Reports/sets high range NO _x coefficients	B-25
high nox gas	Reports high range NO _x span gas concentration	B-25
high range no	Reports/selects current NO high range	B-29
high range no2	Reports/selects current NO ₂ high range	B-29
high range nox	Reports/selects current NO _x high range	B-29
host name	Reports/sets host name string	B-38
instr name	Reports instrument name	B-39
instrument id	Reports/sets instrument id	B-39
internal temp	Reports current internal instrument temperature	B-10
isc (iscreen)	Retrieves framebuffer data used for the display	B-27
layout ack	Disables stale layout/layout changed indicator ("**")	B-40
le (left)	Simulates pressing left pushbutton	B-27
list din	Lists current selection for digital input	B-17
list dout	Lists current selection for digital output	B-17
list lrec	Lists current selection lrec logging data	B-17
list sp	Lists current selection in the scratchpad list	B-17
list srec	Lists current selection srec logging data	B-17
list stream	Lists current selection streaming data output	B-17
list var aout	Reports list of analog output, index numbers, and variables	B-43
list var din	Reports list of digital input, index numbers, and variables	B-43
list var dout	Reports list of digital output, index numbers, and variables	B-43
low avg time	Reports/sets low averaging time	B-9
low no	Reports NO concentration calculated with low range coefficients	B-10
low no coef	Reports/sets low range NO coefficient	B-25
low no gas	Reports/sets low range NO span gas concentration	B-25
low no2	Reports NO ₂ concentration calculated with low range coefficients	B-10
low no2 coef	Reports/sets low range NO ₂ coefficient	B-25
low no2 gas	Reports/sets low range NO ₂ span gas concentration	B-25
low nox	Reports NO _x concentrations calculated with low range coefficients	B-10
low nox coef	Reports/sets low range NO _x coefficient	B-24
low nox gas	Reports/sets low range NO _x span gas concentration	B-25
low range no	Reports/sets current NO low range	B-29

Table B-1. C-Link Protocol Commands, continued

Command	Description	Page
low range no2	Reports/sets current NO ₂ low range	B-29
low range nox	Reports/sets current NO _x low range	B-29
lr	Outputs long records in the format specified in the command	B-18
lrec	Outputs long records	B-18
lrec format	Reports/sets output format for long records (ASCII or binary)	B-20
lrec layout	Reports current layout of lrec data	B-20
lrec mem size	Reports maximum number of long records that can be stored	B-21
lrec per	Reports/sets long record logging period	B-21
malloc lrec	Reports/sets memory allocation for long records	B-21
malloc srec	Reports/sets memory allocation for short records	B-21
me (menu)	Simulates pressing menu pushbutton	B-27
meas mode	Reports/sets which measurement mode is active	B-31
mode	Reports operating mode in local, service, or remote	B-39
no	Reports current NO concentration	B-10
no bkg	Reports/sets current NO background	B-26
no coef	Reports/sets current NO coefficient	B-25
no gas	Reports/sets NO span gas concentration	B-25
no of lrec	Reports/sets number of long records stored in memory	B-21
no of srec	Reports/sets number of short records stored in memory	B-21
no2	Reports current NO ₂ concentration	B-10
no2 coef	Reports/sets current NO ₂ coefficient	B-25
no2 gas	Reports/sets NO ₂ span gas concentration	B-25
nox	Reports current NO _x concentration	B-10
nox bkg	Reports/sets current NO _x background	B-26
nox coef	Reports/sets current NO _x coefficient	B-25
nox gas	Reports/sets NO _x span gas concentration	B-25
ozonator	Reports/sets ozonator on or off	B-34
ozonator flow	Reports current ozonator flow	B-34
ozonator safety	Reports/sets ozonator safety on or off	B-34
ozonator status	Reports status of ozonator and safety	B-35
pmt status	Reports/sets PMT status on or off	B-35
pmt temp	Reports temperature of the PMT cooler (same as cooler temperature)	B-11
pmt voltage	Reports current PMT voltage	B-11

Table B-1. C-Link Protocol Commands, continued

Command	Description	Page
pres	Reports current reaction chamber pressure	B-11
pres cal	Reports/sets pressure used for calibration	B-27
pres comp	Reports/sets pressure compensation on or off	B-32
program no	Reports analyzer program number	B-39
push	Simulates pressing a key on the front panel	B-27
range mode	Reports/sets current range mode	B-30
range no	Reports/sets current NO range	B-29
range no2	Reports/sets current NO ₂ range	B-29
range nox	Reports/sets current NO _x range	B-29
react temp	Reports current reaction chamber temperature	B-11
relay stat	Reports/sets relay logic status to for the designated relay(s)	B-43
ri (right)	Simulates pressing right pushbutton	B-27
ru (run)	Simulates pressing run pushbutton	B-27
sample	Sets zero/span valves to sample mode	B-31
save	Stores parameters in FLASH	B-35
save params	Stores parameters in FLASH	B-35
sc (screen)	C-series legacy command that reports a generic response (Use iscreen instead)	B-28
sp field	Reports/sets item number and name in scratch pad list	B-22
span	Sets zero/span valves to span mode	B-31
sr	Reports last short record stored	B-18
srec	Reports maximum number of short records	B-18
srec format	Reports/sets output format for short records (ASCII or binary)	B-20
srec layout	Reports current layout of short record data	B-20
srec mem size	Reports maximum number of short records	B-21
srec per	Reports/sets short record logging period	B-21
stream per	Reports/sets current set time interval for streaming data	B-23
stream time	Reports/sets a time stamp to streaming data or not	B-23
temp comp	Reports/sets temperature compensation on or off	B-32
time	Reports/sets current time (24-hour time)	B-35
up	Simulates pressing up pushbutton	B-27
zero	Sets zero/span valves to zero mode	B-31

Measurements

avg time

high avg time

low avg time

These commands report the averaging time in seconds when operating in single range, or averaging time used with the high and low ranges when operating in dual or auto range mode. The example below shows that the averaging time is 300 seconds, according to [Table B-2](#).

```
Send:    avg time
Receive: avg time 11: 300 sec
```

set avg time selection

set high avg time selection

set low avg time selection

These commands set the averaging time, high and low averaging times, according to [Table B-2](#). The example below sets the low range averaging time to 120 seconds.

```
Send:    set low avg time 8
Receive: set low avg time 8 ok
```

Table B-2. Averaging Times

<i>Selection</i>	Time, NO Measure Mode, NO_x Measure Mode	Time, NO/NO_x Measure Mode
0	1 seconds	
1	2	
2	5	
3	10	10 seconds
4	20	20
5	30	30
6	60	60
7	90	90
8	120	120
9	180	180
10	240	240
11	300	300

no
no2
nox
high no
high no2
high nox
low no
low no2
low nox

These commands report the measured NO, NO₂, and NO_x concentrations when operating in single range, or high and low NO, NO₂, and NO_x when operating in dual or auto range mode. The example below shows that the NO concentration is 62.7 ppm.

Send: no
Receive: no 6270E-2 ppm

conv temp

This command reports the current NO₂ converter temperature. The example below reports that the current converter temperature is 625 °C.

Send: conv temp
Receive: conv temp 625 deg C

cooler temp

This command reports the photomultiplier tube cooler temperature. The example below reports that the PMT cooler temperature is -2.8 °C.

Send: pmt temp
Receive: pmt temp -2.8 deg C

flow

This command reports the current measured flow. The example below reports that the flow measurement is 0.700 LPM.

Send: flow
Receive: flow 0.7 l/min

internal temp

This command reports the current internal instrument temperature. The example below shows that the internal temperature is 28.6 °C.

Send: internal temp
Receive: internal temp 28.6 deg C, actual 28.6

pmt temp

This command reports the PMT cooler temperature. The example below reports that the PMT cooler temperature is -2.8 °C.

```
Send:    pmt temp
Receive: pmt temp -2.8 deg C
```

pmt voltage

This command reports the current PMT voltage. The example below reports that the current PMT voltage is -750 volts.

```
Send:    pmt voltage
Receive: pmt voltage -750
```

pres

This command reports the current reaction chamber pressure. The example below shows that the actual reaction chamber pressure is 33.8 mmHg.

```
Send:    pres
Receive: pres 33.8 mm Hg
```

react temp

This command reports the current reaction chamber temperature. The example below reports that the current reaction chamber temperature is 49.0 °C.

```
Send:    react temp
Receive: react temp 49.0 deg C
```

flags

This reports 8 hexadecimal digits (or flags) that represent status of the ozonator, PMT, pressure and temperature compensation status, gas units, gas mode, and alarms. To decode the flags, each hexadecimal digit is converted to binary as shown in the [Figure B-1](#). It is the binary digits that define the status of each parameter. In the example below, the instrument is reporting that the ozonator and PMT are both on, that the instrument is in the span gas mode, that at least one of the alarm temperature is activated, and that the NO₂ high concentration alarm is activated.

```
Send:    flags
Receive: flags C0028008
```

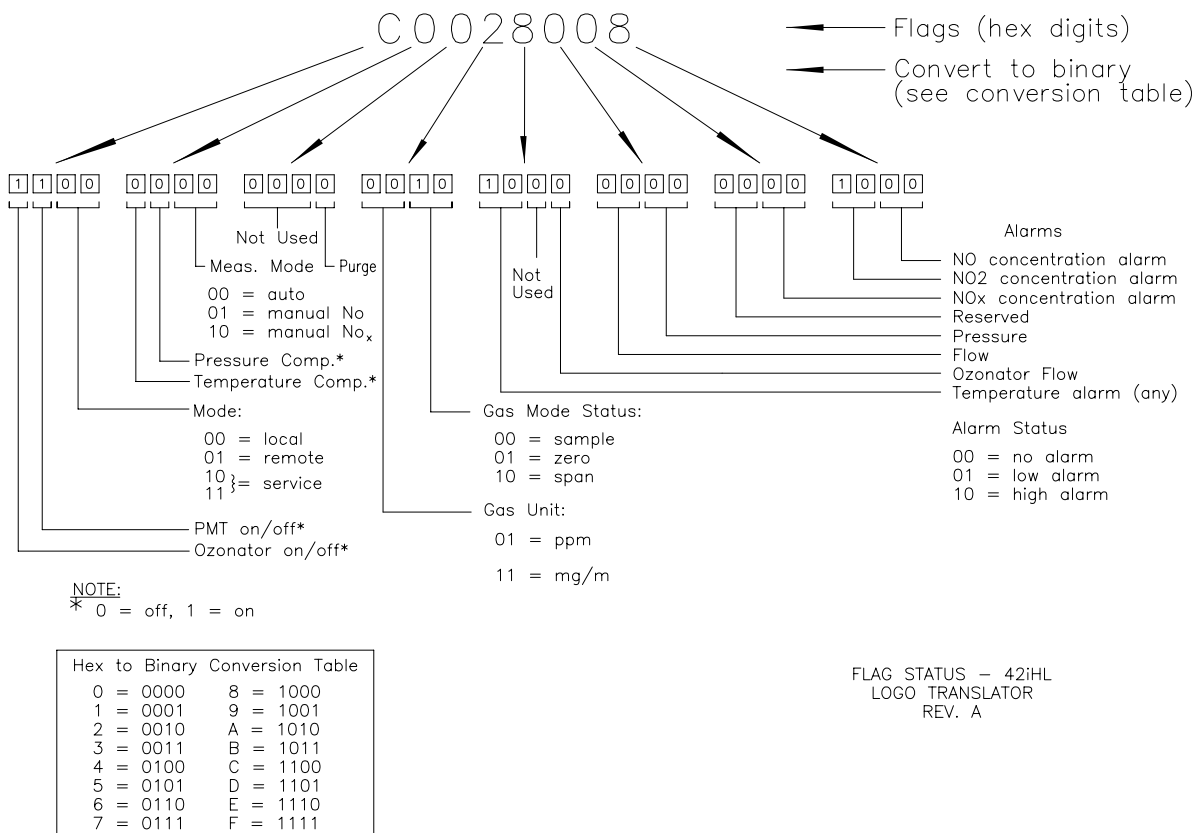

Figure B-1. Flag Status

Alarms

alarm chamber temp min

alarm chamber temp max

These commands report the chamber temperature alarm minimum and maximum value current settings. The example below reports that the chamber temperature alarm minimum value is 47.0 °C.

```
Send:    alarm chamber temp min
Receive: alarm chamber temp min 47.0 deg C
```

set alarm chamber temp min *value*

set alarm chamber temp max *value*

These commands set the chamber temperature alarm minimum and maximum values to *value*, where *value* is a floating-point number representing chamber temperature alarm limits in degrees C. The example below sets the chamber temperature alarm maximum value to 50.0 °C.

```
Send:      set alarm chamber temp max 50.0
Receive:   set alarm chamber temp max 50.0 ok
```

alarm conc no min
alarm conc no2 min
alarm conc nox min
alarm conc no max
alarm conc no2 max
alarm conc nox max

These commands report the NO, NO₂, and NO_x concentrations alarm minimum and maximum value current setting. The example below reports that the NO concentration minimum is 5.2 ppm.

```
Send:      alarm conc no min
Receive:   alarm conc no min 5.2 ppm
```

set alarm conc no min *value*
set alarm conc no2 min *value*
set alarm conc nox min *value*
set alarm conc no max *value*
set alarm conc no2 max *value*
set alarm conc nox max *value*

These commands set the NO, NO₂, and NO_x concentrations alarm minimum and maximum value to *value*, where *value* is a floating-point representation of the concentration alarm limits. Values must be in the units that are currently set for use. The example below sets the NO concentration alarm maximum value to 215.

```
Send:      set alarm conc no max 215
Receive:   set alarm conc no max 215 ok
```

alarm converter temp min
alarm converter temp max

These commands report the converter temperature alarm minimum and maximum value current settings. The example below reports that the converter temperature alarm minimum value is 600.0 °C.

```
Send:      alarm converter temp min
Receive:   alarm converter temp min 600.0 deg C
```

set alarm converter temp min *value*
set alarm converter temp max *value*

These commands set the converter temperature alarm minimum and maximum values to *value*, where *value* is a floating-point number representing converter temperature alarm limits in degrees C. The example below sets the converter temperature alarm maximum value to 640.0 °C.

```
Send:      set alarm converter temp max 640
Receive:   set alarm converter temp max 640 ok
```

alarm cooler temp min**alarm cooler temp max**

These commands report the cooler temperature alarm minimum and maximum value current settings. The example below reports that the cooler temperature alarm minimum value is -10.0 °C.

```
Send:      alarm cooler temp min
Receive:   alarm cooler temp min -10.0 deg C
```

set alarm cooler temp min *value***set alarm cooler temp max *value***

These commands set the cooler temperature alarm minimum and maximum values to *value*, where *value* is a floating-point number representing cooler temperature alarm limits in degrees C. The example below sets the cooler temperature alarm maximum value to -2.0 °C.

```
Send:      set alarm cooler temp max -2
Receive:   set alarm cooler temp max -2 ok
```

alarm internal temp min**alarm internal temp max**

These commands report the internal temperature alarm minimum and maximum value current settings. The example below reports that the internal temperature alarm minimum value is 15.0 °C.

```
Send:      internal temp alarm min
Receive:   internal temp alarm min 15.0 deg C
```

set internal temp alarm min *value***set internal temp alarm max *value***

These commands set the internal temperature alarm minimum and maximum values to *value*, where *value* is a floating-point number representing internal temperature alarm limits in degrees C. The example below sets the internal temperature alarm maximum value to 35.0 °C.

```
Send:      set internal temp alarm max 35
Receive:   set internal temp alarm max 35 ok
```

alarm pressure min**alarm pressure max**

These commands report the pressure alarm minimum and maximum value current settings. The example below reports that the pressure alarm minimum value is 20 mmHg.

Send: pressure alarm min
Receive: pressure alarm min 20 mm Hg

set alarm pressure min *value*

set alarm pressure max *value*

These commands set the pressure alarm minimum and maximum values to *value*, where *value* is a floating-point number representing pressure alarm limits in millimeters of mercury. The example below sets the pressure alarm maximum value to 90 mmHg.

Send: set alarm pressure max 90
Receive: set alarm pressure max 90 ok

alarm sample flow min

alarm sample flow max

These commands report the sample (or bypass, if installed) flow alarm minimum and maximum value current settings. The example below reports that the sample flow alarm minimum value is 0.300 LPM.

Send: alarm sample flow min
Receive: alarm sample flow min 0.3 l/min

set alarm sample flow min *value*

set alarm sample flow max *value*

These commands set the sample (or bypass, if installed) flow alarm minimum and maximum values to *value*, where *value* is a floating-point number representing sample flow alarm limits in liters per minute. The example below sets the sample flow alarm maximum value to 1.000 LPM.

Send: set alarm sample flow max 1
Receive: set alarm sample flow max 1 ok

alarm trig conc no

alarm trig conc no2

alarm trig conc nox

These commands report the NO, NO₂, and NO_x concentrations alarm trigger action for minimum alarm, current setting, to either floor or ceiling. The example below shows the NO concentration minimum alarm trigger to ceiling, according to [Table B-3](#).

Send: alarm trig conc no
Receive: alarm trig conc no 1

set alarm trig conc no *value*

set alarm trig conc no2 *value*

set alarm trig conc nox *value*

These commands set the NO, NO₂, and NO_x concentrations alarm minimum *value*, where *value* is set to either floor or ceiling, according to [Table B-3](#). The example below sets the NO concentration minimum alarm trigger to ceiling.

```
Send:    set alarm trig conc no 1
Receive: set alarm trig conc no 1 ok
```

Table B-3. Alarm Trigger Values

<i>Value</i>	Alarm Trigger
0	Floor
1	Ceiling

Diagnostics

diag volt mb

This command reports the diagnostic voltage measurements on the motherboard. The sequence of voltages is: Positive 24, positive 15, positive 5, positive 3.3, and negative 3.3. Each voltage value is separated by a space.

```
Send:    diag volt mb
Receive:  diag volt mb 24.1 14.9 4.9 3.2 -3.2
```

diag volt mib

This command reports the diagnostic voltage measurements on the measurement interface board. The sequence of voltages is: Positive 24, positive 15, negative 15, positive 5, positive 3.3, and positive 15. Each voltage value is separated by a space.

```
Send:    diag volt mib
Receive:  diag volt mib 24.1 14.9 -14.9 4.9 3.2 14.9
```

diag volt iob

This command reports the diagnostic voltage measurements on the I/O expansion board. The sequence of voltages is: Positive 24, positive 5, positive 3.3, and negative 3.3. Each voltage value is separated by a space.

```
Send:    diag volt iob
Receive:  diag volt iob 24.1 4.9 3.2 -3.2
```

Datalogging

clr records

This command will clear all long and short records that have been saved.

Send: clear records
Receive: clear records ok

set clr lrecs

set clr srecs

These commands will clear only the long records or only the short records that have been saved. The example below clears short records.

Send: set clr srecs
Receive: set clr srecs ok

list din

list dout

These commands report the current selection for the digital outputs in the format. Output no Index number variable name active state. The active state for digital outputs is open or closed. The active state for digital inputs is high or low.

Send: list dout
Receive: list dout
output index variable state
1 35 CONC ALARM open
3 4 UNITS open
4 11 GEN ALARM closed
7 7 NO MODE open
8 8 NOX MODE open

list lrec

list srec

list stream

list sp

These commands report the list of current selections for long record logging data, short record logging data, streaming data output, or the scratch pad (sp) list. The example below shows the list for streaming data output.

Send: list stream
Receive: list stream
field index variable
x x time
1 1 no
2 2 no2
3 3 nox
4 18 intt
5 25 pres
6 26 smplf

er *xy***lr** *xy***sr** *xy*

$x = | 0 | 1 |$: Reply termination format (see “set format *format*” command)

$y = | 0 | 1 | 2 |$: Output format (see “set errec/lrec/srec format *format*” command)

These commands report the last long and short records stored or the dynamic data record. In the example below, the command requests a long record with no checksum, in ASCII format with text. For details on how to decode the flag fields within these records, see [Figure B-1](#) in the “flags” command.

```
Send:      lr01
Receive:   lr01
12:31 02-22-03 flags 54089100 no -8413E-1 nox -8485E-1 lono -6471E-1
lonox -6527E-1 pres 130.9 pmtt 53.2 intt 80.0 rctt 80.0 convt 61 smplf
0.500 ozonf 0.000 pmtv -115
```

errec

This command returns a brief description of the main operating conditions at the time the command is issued (i.e. dynamic data). The example below shows a typical response. The format is defined by the current settings of “format” and “errec format” commands. For details on how to decode the flag fields within these records, see [Figure B-1](#) in the “flags” command.

```
Send:      errec
Receive:   errec
10:11 04-06-05 flags DD008000 no 0.000 nox 0.000 no2 0.000 1 lono
147.500 lonox 0.000 lono2 0.000 1 pmtv 805.491 tempal 1 pres 172.278
pcal 150.000 smplf 0.000 ozonf 0.050 hiavgtime 10 loavgtime 10 nobkg
0.000 noxbkg 0.000 nocoef 1.000 noxcoef 1.000 no2coef 1.000 lonocof
1.000 lonoxcoef 1.000 lono2coef 1.000 norange 100000.000 noxrange
100000.000 no2range 100000.000 lonorange 100000.000 lonoxrange
100000.000 lono2range 100000.000
```

lrec**srec****lrec** *xxxx yy***srec** *xxxx yy***lrec** *aa:bb oo-pp-qq yy***srec** *aa:bb oo-pp-qq yy*

xxxx = the number of past records

yy = the number of records to return (1 to 10)

aa = hours (01 to 24)

bb = minutes (01 to 59)

oo = month (01 to 12)

pp = day (01 to 31)

qq = year

These commands output long or short records and dynamic data. The output format is determined by the “set lrec format”, and “set srec format” commands. The logging time is determined by the “set lrec per” and “set srec per” commands. In dual range, the long records and short records contain the high and low NO and NO_x concentrations. In single range the low NO and low NO_x values are set to 0 and the high NO and high NO_x are used. In NO or NO_x only mode, the pertinent high value used, other concentrations are set to 0. Concentrations are stored in either ppm or mg/m³.

In the following example, there are 740 long records currently stored in memory. When the command lrec 100 5 is sent, the instrument counts back 100 records from the last record collected (record 740), and then returns 5 records: 640, 641, 642, 643, and 644. For details on how to decode the flag fields within these records, see [Figure B-1](#) in the “flags” command.

```
Send:      lrec 100 5
Receive:   lrec 100 5
11:03 02-22-03  flags 54089100 no 8416E-1 nox 8458E-1 lono 6474E-1
lonox 6506E-1 pres 131.4 pmtt 53.1 intt 80.0 rctt 80.0 convt 61 smplf
0.500 ozonf 0.000 pmtv -116
11:04 02-22-03  flags 54089100 no 8421E-1 nox 8457E-1 lono 6477E-1
lonox 6505E-1 pres 131.5 pmtt 53.1 intt 80.0 rctt 80.0 convt 61 smplf
0.500 ozonf 0.000 pmtv -116
11:05 02-22-03  flags 54089100 no 8440E-1 nox 8456E-1 lono 6492E-1
lonox 6505E-1 pres 131.5 pmtt 53.2 intt 80.0 rctt 80.0 convt 61 smplf
0.500 ozonf 0.000 pmtv -116
11:06 02-22-03  flags 54089100 no 8432E-1 nox 8483E-1 lono 6486E-1
lonox 6525E-1 pres 133.0 pmtt 53.0 intt 80.0 rctt 80.0 convt 61 smplf
0.500 ozonf 0.000 pmtv -116
11:07 02-22-03  flags 54089100 no 8442E-1 nox 8383E-1 lono 6494E-1
lonox 6449E-1 pres 131.5 pmtt 53.1 intt 80.0 rctt 80.0 convt 61 smplf
0.500 ozonf 0.000 pmtv -116
```

where:

pmtv = PMT Voltage

pmtt = PMT Temperature

intt = Internal Temperature

rctt = Reaction Chamber Temperature

convt = NO₂ Converter Temperature

smplf = Sample Flow

ozonf = Ozonator Flow

pres = Pressure

erec format

srec format

lrec format

These commands report the output format for long and short records, and dynamic data in various formats such as ASCII without text, ASCII with text, or binary. The example below shows the output format for long records is ASCII with text, according to [Table B-4](#).

```
Send:      lrec format
Receive:   lrec format 1
```

set erec format *format*

set lrec format *format*

set srec format *format*

These commands set the output format for long and short records, and dynamic data, according to [Table B-4](#). The example below sets the long record output format to ASCII with text.

```
Send:      set lrec format 1
Receive:   set lrec format 1 ok
```

Table B-4. Record Output Formats

<i>Format</i>	Output Format
0	ASCII no text
1	ASCII with text
2	binary data

erec layout

lrec layout

srec layout

These commands reports the layout (string indicating the data formats) for data that is sent out in response to the erec, lrec, srec, and related commands. The example below shows a typical response. For details on how to interpret the strings, see “Record Layout Definition” later in this appendix.

```
Send:      lrec layout
Receive:   lrec layout %s %s %lx %f %f %f %f %f %f %f %f %f %f %f %f
t D L ffffffff
flags no nox hino hinox pres pmtt intt rctt convt smplf ozonf pmtv
```

lrec mem size**srec mem size**

These commands report the long and short records that can be stored with the current settings and the number of blocks reserved for long and short records. To calculate the number of short records per block, add 2 to the number of records, and then divide by the number of blocks. The example below shows that 7 blocks were reserved for long records, and the maximum number of long records that can be stored in memory is 1426.

```
Send:    lrec mem size
Receive: lrec mem size 1426 recs, 7 blocks
```

lrec per**srec per**

These commands report the long and short records logging period. The example below shows that the short record logging period is 5 minutes.

```
Send:    srec per
Receive: srec per 5 min
```

set srec per *value***set lrec per *value***

value = | 1 | 5 | 15 | 30 | 60 |

These commands set the long and short records logging period to *value* in minutes. The example below sets the long record logging period to 15 minutes.

```
Send:    set lrec per 15
Receive: set lrec per 15 ok
```

no of lrec**no of srec**

These commands report the number of long and short records stored in the long and short records memory. The example below shows that 50 long records have been stored in the memory.

```
Send:    no of lrec
Receive: no of lrec 50 recs
```

malloc lrec**malloc srec**

These commands report the currently set memory allocation for long and short records in percent of total memory.

```
Send:    malloc lrec
Receive: malloc lrec 10%
```

set malloc lrec *value*

set malloc srec *value*

value = 0 to 100

These commands set the percent of memory space allocated for long and short records to *value*, where *value* is a floating-point number representing percent. The example below sets the memory allocation for long records to 10.

Note Issuing these commands will clear all the logging data memory. All the existing records should be retrieved using appropriate commands, if required. ▲

Send: set malloc lrec 10
Receive: set malloc lrec 10 ok

set copy sp to lrec

set copy sp to srec

set copy sp to stream

These commands copy the current selections in scratch pad (sp) into the long record, short record, or streaming data list. The example below copies the current list in scratch pad into the long records list.

Send: set copy sp to lrec
Receive: set copy sp to lrec ok

set copy lrec to sp

set copy srec to sp

set copy stream to sp

These commands copy the current contents of the long record, short record, or streaming data list into the scratch pad (sp). These commands are useful in easy modification of current long record, short record, or streaming data lists. The example below copies the current list of long records into the scratch pad.

Send: set copy lrec to sp
Receive: set copy lrec to sp ok

sp field *number*

This command reports the variable *number* and name stored at index in the scratch pad list. The example below shows that the field 5 in the scratch pad is set to index number 13, which is for the variable NO_x concentration.

Send: sp field 5
Receive: sp field 5 13 pres

sp field *number value*

number = 1-32 is the maximum number of fields in long and short record lists.

number = 1-18 is for streaming data lists.

This command sets the scratch pad field *number* (item number in scratch pad list) to *value*, where *value* is the index number of a variable in the analog out variable list. Available variables and their corresponding index numbers may be obtained using the command “list var aout”. The “set sp field” command is used to create a list of variables which can then be transferred into the long record, short record, or streaming data lists, using the “set copy sp to lrec”, “set copy sp to srec”, or “set copy sp to stream” commands.

```
Send:      set sp field 1 34
Receive:   set sp field 1 34 ok
```

stream per

This command reports the currently set time interval in seconds for streaming data.

```
Send:      stream per
Receive:   stream per 10
```

set stream per *number value*

number value = | 1 | 2 | 5 | 10 | 20 | 30 | 60 | 90 | 120 | 180 | 240 | 300 |

This command sets the time interval between two consecutive streaming data strings to *number value* in seconds. The example below sets the number value to 10 seconds.

```
Send:      set stream per 10
Receive:   set stream per 10 ok
```

stream time

This command reports if the streaming data string will have a time stamp attached to it or not, according to [Table B-5](#).

```
Send:      stream time
Receive:   stream time 1
```

set stream time *value*

This command enables *value*, where *value* is to attach or disable time stamp to streaming data string, according to [Table B-5](#). The example below attaches a time stamp to streaming data.

Send: set stream time 0
 Receive: set stream time 0 ok

Table B-5. Stream Time Values

<i>Value</i>	Stream Time
0	Attaches time stamp to streaming data string
1	Disables time stamp to streaming data string

Calibration

set cal no coef

set cal no2 coef

set cal nox coef

set cal high no coef

set cal high no2 coef

set cal high nox coef

set cal low no coef

set cal low no2 coef

set cal low nox coef

These commands will auto-calibrate the NO, NO₂, and NO_x coefficients based on the NO, NO₂, and NO_x span gas concentrations. The high and low commands are only available in dual and auto range mode. If the mode is incorrect, the instrument responds with “can’t, wrong settings”. The example below shows a successful auto-calibration of the low NO coefficient.

Send: set cal low no coef
 Receive: set cal low no coef ok

set cal no bkg

set cal nox bkg

These commands will auto-calibrate the NO and NO_x backgrounds. If the instrument is set to manual NO_x mode, the response to “set cal no bkg” will be “can’t, wrong settings”. The example below shows a successful auto-calibration of the NO background.

Send: set cal no bkg
 Receive: set cal no bkg ok

no coef
no2 coef
nox coef
high no coef
high no2 coef
high nox coef
low no coef
low no2 coef
low nox coef

These commands report the NO, NO₂, and NO_x coefficients in single range mode, or the high and low range coefficients in dual or auto range mode. If the mode is incorrect, the instrument responds with “can’t, wrong settings”. The example below reports that the NO coefficient is 1.000.

Send: no coef
Receive: no coef 1.000

set no coef *value*
set no2 coef *value*
set nox coef *value*
set high no coef *value*
set high no2 coef *value*
set high nox coef *value*
set low no coef *value*
set low no2 coef *value*
set low nox coef *value*

These commands set the NO, NO₂, and NO_x coefficients to user-defined values to *value*, where *value* is a floating-point representation of the coefficient. The example below sets the NO coefficient to 1.005.

Send: set no coef 1.005
Receive: set no coef 1.005 ok

no gas
no2 gas
nox gas
high no gas
high no2 gas
high nox gas
low no gas
low no2 gas
low nox gas

These commands report the low NO, NO₂, and NO_x span gas concentrations used to auto-calibrate low NO, NO₂, and NO_x coefficients. The high and low commands are only available in dual and auto range

mode. If the mode is incorrect, the instrument responds with “can’t, wrong settings”. The example below shows that the NO low span gas concentration is 240.0 ppm.

```
Send:    low no gas
Receive: low no gas 240E-1 ppm
```

```
set no gas value
set no2 gas value
set nox gas value
set high no gas value
set high no2 gas value
set high nox gas value
set low no gas value
set low no2 gas value
set low nox gas value
```

These commands set the NO, NO₂, and NO_x span gas concentrations used by the auto-calibration routine to *value*, where *value* is a floating-point representation of the gas concentration in current selected units. The gas units are the same as those chosen by the user. The example below sets the NO span gas concentration to 123.4 ppm.

```
Send:    set no gas 123.4
Receive: set no gas 123.4 ok
```

```
no bkg
nox bkg
```

These commands report the current NO and NO_x backgrounds. The example below reports that the NO background is 55 ppm.

```
Send:    no bkg
Receive: no bkg 55 ppm
```

```
set no bkg value
set nox bkg value
```

These commands are used to set NO and NO_x backgrounds to user-defined values to *value*, where *value* is a floating-point representation of the background in current selected units. The example below sets the NO background to 55 ppm.

```
Send:    set no bkg 55
Receive: set no bkg 55 ok
```

pres cal

This command reports the pressure recorded at the time of calibration. The example below shows that the pressure at calibration is 33.8 mmHg.

```
Send:    pres cal
Receive: pres cal 33.8 mmHg
```

set pres cal

This command automatically sets the current pressure as the calibration pressure. The example below successfully sets the calibration pressure to 35.0 mmHg.

```
Send:    set pres cal 35.0
Receive: set pres cal 35.0 ok
```

set cal pres

This command automatically sets the current pressure as the calibration pressure. The example below successfully sets the calibration pressure.

```
Send:    set cal pres
Receive: set cal pres ok
```

Keys/Display

push *button*

button = | do | down | en | enter | he | help | le | left | me | menu | ri | right |
ru | run | up | 1 | 2 | 3 | 4 |

These commands simulates pressing the front panel pushbuttons. The numbers represent the front-panel soft keys, from left to right.

```
Send:    push enter
Receive: push enter ok
```

isc**iscreen**

This command retrieves the framebuffer data used for the display on the iSeries instrument. It is 19200 bytes in size, 2-bits per pixel, 4 pixels per byte arranged as 320 by 240 characters. The data is sent in RLE encoded form to save time in transmission. It is sent as a type '5' binary c_link response with no checksum.

The RLE encoding consists of a 0 followed by an 8-bit count of consecutive 0xFF bytes. The following 'c' code will expand the incoming data.

```

Void    unpackDisplay ( void far* tdib, unsigned char far* rlescreen )
{
int i,j,k;
unsigned char far *sc4bpp, *sc2bpp, *screen, *ptr;

ptr = screen = (unsigned char far *)malloc(19200);
//RLE decode the screen
for (i=0; i<19200 && (ptr - screen) < 19200; i++)
{
    *(ptr++) = *(rlescreen + i);
    if (*(rlescreen + i) == 0)
    {
        unsigned char rlecount = *(unsigned char *)(rlescreen + ++i);
        while (rlecount)
        {
            *(ptr++) = 0;
            rlecount--;
        }
    }
    else if (*(rlescreen + i) == 0xff)
    {
        unsigned char rlecount = *(unsigned char *)(rlescreen + ++i);

        while (rlecount)
        {
            *(ptr++) = 0xff;
            rlecount--;
        }
    }
}
}

```

To convert this data into a BMP for use with windows, it needs to be turned into a 4BPP as that is the smallest windows can display. Also note that BMP files are upside down relative to this data, i.e. the top display line is the last line in the BMP.

sc
screen

This command is meant for backward compatibility on the C series. Screen information is reported using the “iScreen” command above.

Send: screen

Receive: screen This is an I series Instrument. Screen Information not available

Measurement Configuration

range no
range no2
range nox
high range no
high range no2
high range nox
low range no
low range no2
low range nox

These commands report the NO, NO₂, and NO_x ranges in single range mode, or the high and low ranges in dual or auto range mode, according to [Table B-6](#). If the mode is incorrect, the instrument responds with “can’t, wrong settings”. The example below reports that the NO range is 20 ppm.

Send: range no
Receive: range no 0: 2000E-2 ppm

set range no *selection*
set range no2 *selection*
set range nox *selection*
set high range no *selection*
set high range no2 *selection*
set high range nox *selection*
set low range no *selection*
set low range no2 *selection*
set low range nox *selection*

These commands select the NO, NO₂, and NO_x full-scale ranges, according to [Table B-6](#). The example below sets the NO_x full-scale to 2,000 ppm.

Send: set range nox 7
Receive: set range nox 7 ok

Table B-6. Operating Ranges

<i>Selection</i>	ppm	mg/m³
0	10	20
1	20	50
2	50	100
3	100	200
4	200	500
5	500	1,000
6	1,000	2,000
7	2,000	5,000

Table B-6. Operating Ranges, continued

<i>Selection</i>	<i>ppm</i>	<i>mg/m³</i>
8	5,000	7,500
9	C1	C1
10	C2	C2
11	C3	C3

custom range

range = | 1 | 2 | 3 |

This command reports the user-defined value of custom *range* 1, 2, or 3. The example below reports that custom range 1 is defined to 55.0 ppm.

Send: custom 1
Receive: custom 1 5500E-2 ppm

set custom range value

set custom 1 value

set custom 2 value

set custom 3 value

set custom 1 range value

set custom 2 range value

set custom 3 range value

These commands are used to set the maximum concentration for any of the three custom *ranges* 1, 2, or 3 to range *value*, where *value* is a floating-point number representing concentration in ppm or mg/m³. The example below sets the custom 1 range to 55.5 ppm.

Send: set custom 1 range 55.5
Receive: set custom 1 range 55.5 ok

range mode

This command reports the current range mode.

Send: range mode
Receive: range mode single

set range mode mode

This command sets the current range mode to single, dual, or auto. The example below sets the range mode to single.

Send: set range mode single
Receive: set range mode single ok

gas mode

This command reports the current mode of sample, zero, or span. The example below reports that the gas mode is sample.

Send: gas mode
Receive: gas mode sample

set sample

set zero

set span

These commands set the current gas mode to sample, zero, or span. The example below sets the instrument to span mode, that is, the instrument is sampling span gas.

Send: set span
Receive: set span ok

gas unit

This command reports the current gas units (ppm or mg/m³). The example reports that the gas unit is set to ppm.

Send: gas unit
Receive: gas unit ppm

set gas *unit*

unit = | ppm | mg/m³ |

This command sets the gas units to ppm or mg/m³. The example below sets the gas unit to mg/m³.

Send: set gas unit mg/m3
Receive: set gas unit mg/m3 ok

meas mode

This command reports which measurement mode (NO/NO_x, NO, NO_x) is active. The example below reports that the measurement mode is set to NO.

Send: meas mode
Receive: meas mode no

set meas mode *mode*

mode = | no/nox | no | nox |

This command sets the instrument to NO/NO_x (auto) mode, manual NO mode, or manual NO_x mode. The example below sets the instrument to the manual NO mode.

```
Send:      set meas mode no  
Receive:   set meas mode no ok
```

pres comp

This command reports whether pressure compensation is on or off. The example below shows that pressure compensation is on.

```
Send:      pres comp  
Receive:   pres comp on
```

set pres comp *onoff*

These commands turn the pressure compensation *on* or *off*. The example below turns pressure compensation off.

```
Send:      set pres comp off  
Receive:   set pres comp off ok
```

temp comp

This command reports whether temperature compensation is on or off. The example below shows the temperature compensation is off.

```
Send:      temp comp  
Receive:   temp comp off
```

set temp comp *onoff*

These commands turn the temperature compensation *on* or *off*. The example below turns temperature compensation off.

```
Send:      set temp comp off  
Receive:   set temp comp off ok
```

Hardware Configuration

contrast

This command reports the screen's level of contrast. The example below shows the screen contrast is 50%, according to [Table B-7](#).

```
Send:      contrast  
Receive:   contrast 5: 50%
```

set contrast *level*

This command sets the screen's *level* of contrast, according to [Table B-7](#). The example below sets the contrast level to 50%.

```
Send:      set contrast 5  
Receive:   set contrast 5 ok
```

Table B-7. Contrast Levels

<i>Level</i>	Contrast Level
0	0%
1	10%
2	20%
3	30%
4	40%
5	50%
6	60%
7	70%
8	80%
9	90%
10	100%

conv set temp

This command reports the temperature that the NO₂ converter is set to. The example below reports that the converter temperature is set to 625 °C.

```
Send:      conv set temp
Receive:   conv set temp 625 deg C
```

set conv set temp *value*

This command sets the temperature that the NO₂ converter is set to, where *value* is an integer representing degrees C. The example below sets the converter temperature to 625 °C.

```
Send:      set conv set temp
Receive:   set conv set temp 625 deg C ok
```

date

This command reports the current date. The example below reports the date as December 1, 2004.

```
Send:      date
Receive:   date 12-01-04
```

set date *mm-dd-yy*

mm = month

dd = day

yy = year

This command sets the date of the analyzer's internal clock. The example below sets the date to March 19, 2005.

```
Send:      set date 03-19-05
Receive:   set date 03-19-05 ok
```

set default params

This command sets all the parameters to their default values. This does not affect the factory-calibrated parameters.

```
Send:      set default params
Receive:   set default params ok
```

ozonator

This command reports the ozonator on or off. The example below reports that the ozonator is on.

```
Send:      ozonator
Receive:   ozonator on
```

set ozonator *onoff*

These commands set the ozonator *on* or *off*. The example below sets the ozonator off.

```
Send:      set ozonator off
Receive:   set ozonator off ok
```

ozonator flow

This command reports the current ozonator flow. The example below reports that the current ozonator flow is 0.050 LPM.

```
Send:      ozonator flow
Receive:   ozonator flow 0.050 l/m
```

ozonator safety

This command reports the status of the ozonator safety on or off. The example below reports that the ozonator safety is on.

```
Send:      ozonator safety
Receive:   ozonator safety on
```

set ozonator safety *onoff*

These commands set the ozonator safety *on* or *off*. The example below sets the ozonator off.

```
Send:      set ozonator safety off
Receive:   set ozonator safety off ok
```

ozonator status

This command reports the status of the ozonator and safety. The example below reports that the ozonator is off.

Send: ozonator status
Receive: ozonator status off

pmt status

This command reports the status of the PMT on or off. The example below reports that the PMT is on.

Send: pmt status
Receive: pmt status on

set pmt *onoff*

These commands set the PMT *on* or *off*. The example below turns the PMT off.

Send: set pmt off
Receive: set pmt off ok

save**set save params**

This command stores all current parameters in FLASH memory. It is important that each time instrument parameters are changed, that this command be sent. If changes are not saved, they will be lost in the event of a power failure. The example below saves the parameters to FLASH memory.

Send: set save params
Receive: set save params ok

time

This command reports the current time (24-hour time). The example below reports that the internal time is 2:15:30 pm.

Send: time
Receive: time 14:15:30

set time *hh:mm:ss*

hh = hours

mm = minutes

ss = seconds

This command sets the internal clock (24-hour time). The example below sets the internal time to 2:15 pm.

Communications Configuration

Note if seconds are omitted, the seconds default to 00. ▲

```
Send:      set time 14:15
Receive:   set time 14:15 ok
```

addr dns

This command reports the TCP/IP address for the domain name server.

```
Send:      addr dns
Receive:   addr dns 192.168.1.1
```

set addr dns *address*

This command sets the domain name server *address*, where *address* consists of four numbers ranging from 0-255 inclusive, separated by “.”.

```
Send:      set addr dns 192.168.1.1
Receive:   set addr dns 192.168.1.1 ok
```

addr gw

This command reports the default TCP/IP gateway address.

```
Send:      addr gw
Receive:   addr gw 192.168.1.1
```

set addr gw *address*

This command sets the default gateway *address*, where *address* consists of four numbers ranging from 0-255 inclusive, separated by “.”.

```
Send:      set addr gw 192.168.1.1
Receive:   set addr gw 192.168.1.1 ok
```

addr ip

This command reports the IP address of the analyzer.

```
Send:      addr ip
Receive:   addr ip 192.168.1.15
```

set addr ip *address*

This command sets the analyzer's IP *address*, where *address* consists of four numbers ranging from 0-255 inclusive, separated by “.”.

```
Send:      set addr ip 192.168.1.15
Receive:   set addr ip 192.168.1.15 ok
```

addr nm

This command reports the TCP/IP netmask address.

```
Send:    addr nm
Receive: addr nm 255.255.255.0
```

set addr nm *address*

This command sets the netmask *address*, where *address* consists of four numbers ranging from 0-255 inclusive, separated by “.”.

```
Send:    set addr nm 255.255.255.0
Receive: set addr nm 255.255.255.0 ok
```

baud

This command reports the current baud rate for the serial port (RS232/RS485). The example below reports that the current baud rate is 9600.

```
Send:    baud
Receive:  baud 9600
```

set baud *rate*

rate = | 1200 | 2400 | 4800 | 9600 | 19200 | 38400 | 57600 | 115200 |

This command sets the instrument baud *rate*. The example below sets the instrument’s baud rate to 115200.

Note After the command is sent, the baud rate of the sending device must be changed to agree with the instrument. ▲

```
Send:    set baud 115200
Receive: set baud 115200 ok
```

dhcp

This command reports the current state of use of DHCP on or off. DHCP is used to assign an IP address to the analyzer automatically. The example below shows that DHCP is on.

```
Send:    dhcp
Receive:  dhcp on
```

set dhcp *onoff*

These commands enables and disables the DHCP service by either *on* or *off*. Changes to this parameter will only take effect when the analyzer is powered up. The example below sets the DHCP service on.

Note When DHCP is set to on, the user-supplied `addr gw`, `addr dns`, `addr ip`, and `addr nm` parameters are not used. ▲

```
Send:      set dhcp on
Receive:   set dhcp on ok
```

format

This command reports the current reply termination format. The example below shows that the reply format is 00, which means reply with no checksum, according to [Table B-8](#).

```
Send:      format
Receive:   format 00
```

set format *format*

This command sets the reply termination *format*, where *format* is set according to [Table B-8](#). The example below sets the reply termination format to checksum.

```
Send:      set format 01
Receive:   set format 01 ok
```

Table B-8. Reply Termination Formats

<i>Format</i>	Reply Termination
00	<CR>
01	<NL> sum xxxx <CR>

where `xxxx` = 4 hexadecimal digits that represent the sum of all the characters (bytes) in the message

host name

This command reports the host name string.

```
Send:      host name
Receive:   host name ISERIES
```

set host name *string*

This command sets the host name *string*, where *string* is 1-13 alphanumeric characters.

```
Send:      set host name analyzer01
Receive:   set host name analyzer01 ok
```

instr name

This command reports the instrument name.

```
Send:      instr name
Receive:   instr name
NO-NO2-NOx Analyzer
NO-NO2-NOx Analyzer
```

instrument id

This command reports the instrument id.

```
Send:      instrument id
Receive:   instrument id 42
```

set instrument id *value*

This command sets the instrument id to *value*, where *value* is a decimal number between 0 and 127 inclusive.

Note sending this command via RS-232 or RS-485 will require the host to use the new id for subsequent commands. ▲

```
Send:      set instrument id 50
Receive:   set instrument id 50 ok
```

mode

This command reports what operating mode the instrument is in: local, service, or remote. The example below shows that the instrument is in the remote mode.

```
Send:      mode
Receive:   mode remote
```

set mode local**set mode remote**

These commands set the instrument to local or remote mode. The example below sets the instrument to the local mode.

```
Send:      set mode local
Receive:   set mode local ok
```

program no

This command reports the analyzer's model information and program version number, which will be dependant on the current version.

```
Send:      program no
Receive:   program no iSeries 42iHL 01.00.01.074
```

set layout ack

This command disables the stale layout/layout change indicator (“*”) that is attached to each response if the layout has changed.

Send: set layout ack
Receive: set layout ack ok

I/O Configuration

analog iout range *channel*

This command reports the analog current output range setting for *channels*, where *channel* must be between 1 and 6, inclusive. The example below reports current output channel 4 to the 4-20 mA range, according to [Table B-9](#). This command responds with “feature not enabled” if the I/O expansion board is not detected.

Send: analog iout range 4
Receive: analog iout range 4 2

set analog iout range *channel range*

This command sets analog current output *channel* to the *channel range* where *channel* is between 1 and 6 inclusive, and *range* is set according to [Table B-9](#). The example below sets current output channel 4 to the 0-20 mA range. This command responds with “feature not enabled” if the I/O expansion board is not detected.

Send: set analog iout range 4 1
Receive: set analog iout range 4 1 ok

Table B-9. Analog Current Output Range Values

<i>Range</i>	Output Range
1	0-20 mA
2	4-20 mA
0 [cannot be set to this, but may report]	Undefined

analog vin *channel*

This command retrieves the analog voltage input *channel* data, both the calculated value and the actual voltage. In the example below, the “calculated” value of channel 1 is 75.325 degrees F, volts are 2.796. This command responds with “feature not enabled” if the I/O expansion board is not detected.

Send: analog vin 1
Receive: analog vin 1 75.325 2.796

analog vout range *channel*

This command reports the analog voltage output *channel* range, where *channel* is between 1 and 6 inclusive, according to [Table B-10](#).

Send: analog vout range 2
Receive: analog vout range 2 3

set analog vout range *channel range*

This command sets analog voltage output *channel* to the range, where *channel* is between 1 and 6 inclusive, and *range* is set according to [Table B-10](#). The example below sets channel 2 to the 0-10 V range.

Send: set analog vout range 2 3
Receive: set analog vout range 2 3 ok

Table B-10. Analog Voltage Output Range Values

<i>Range</i>	Output Range
1	0-1 V
2	0-100 mV
3	0-10 V
4	0-5 V
0 [cannot be set to this, but may report]	Undefined

dig in

This command reports the status of the digital inputs as a 4-digit hexadecimal string with the most significant bit (MSB) being input 16.

Send: dig in
Receive: dig in 0xff7f

din *channel*

This command reports the action assigned to input *channel* and the corresponding active state. The example below reports the input 5 to be assigned an index number 9 corresponding to action of “analog outputs to zero” with the active state being high.

Send: din 5
Receive: din 5 9 AOUTS TO ZERO high

set din *channel index state*

This command assigns digital input *channel* (1-16) to activate the action indicated by *index* (1-35), when the input transitions to the designated *state* (high or low). Use “list din var” command to obtain the list of supported *index* values and corresponding actions.

```
Send:      set din 1 3 high
Receive:   set din 1 3 high ok
```

dout channel

This command reports the index number and output variable and the active state assigned to output *channel*. The example below reports the input 4 to be assigned an index number 11 corresponding to “general alarm” with the active state being open.

```
Send:      dout 4
Receive:   dout 4 11 GEN ALARM open
```

set dout channel index state

This command assigns digital output *channel* to be assigned to the action associated with *index*, and assigns it an active state of *state* (open or closed).

```
Send:      set dout 4 11 open
Receive:   set dout 4 11 open ok
```

dtoa channel

This reports the outputs of the 6 or 12 digital to analog converters, according to [Table B-11](#). The example below shows that the DAC 1 is 97.7% full-scale.

```
Send:      dtoa 1
Receive:   dtoa 1 97.7%
```

Note All channel ranges are user definable. If any customization has been made to the analog output configuration, the default selections may not apply. ▲

Table B-11. Default Output Assignment

D to A	Function	Single Range	Dual Range	Autorange
1	Voltage Output	NO	High NO	High/Low NO
2	Voltage Output	NO ₂	High NO ₂	High/Low NO ₂
3	Voltage Output	NO _x	High NO _x	High/Low NO _x
4	Voltage Output	Not Assigned	Low NO	Range Status
5	Voltage Output	Not Assigned	Low NO ₂	Not Assigned
6	Voltage Output	Not Assigned	Low NO _x	Not Assigned
7	Current Output	NO	High NO	High/Low NO
8	Current Output	NO ₂	High NO ₂	High/Low NO ₂
9	Current Output	NO _x	High NO _x	High/Low NO _x

Table B-11. Default Output Assignment, continued

D to A	Function	Single Range	Dual Range	Autorange
10	Current Output	Not Assigned	Low NO	Range Status
11	Current Output	Not Assigned	Low NO ₂	Not Assigned
12	Current Output	Not Assigned	Low NO _x	Not Assigned

list var aout

list var dout

list var din

These commands report the list of index numbers, and the variables (associated with that index number) available for selection in the current mode (determined by single/dual/auto, gas mode no/no_x or no/no_x) for analog output, digital output and digital inputs. The index number is used to insert the variable in a field location in a list using “set sp *field index*”. The example below reports the list of analog output, index numbers, and variables.

```
Send:      list var aout
Receive:   list var aout
index variable
0 none
1 no
2 no2
3 nox
18 intt
19 rctt
20 pmtt
21 convt
25 pres
26 smp1f
27 pmtv
28 ain1
29 ain2
30 ain3
31 ain4
32 ain5
33 ain6
34 ain7
35 ain8
```

relay stat

This command reports the current relay logic normally “open” or normally “closed,” if all the relays are set to same state, that is all open or all closed. The example below shows that the status when all the relays logic is set to normally “open”.

```
Send:      relay stat
Receive:   relay stat open
```

Note if individual relays have been assigned different logic then the response would be a 4-digit hexadecimal string with the least significant byte (LSB) being relay no 1. ▲

For example:

Receive: relay stat 0x0001 (indicates relay no 1 is set to normally open logic, all others are normally closed)

Receive: relay stat 0x0005 (indicates relay no 1 and 3 are set to be normally open logic, all others are normally closed)

set relay open

set relay open *value*

set relay closed

set relay closed *value*

These commands set the relay logic to normally open or closed for relay number *value*, where *value* is the relay between 1 and 16. The example below sets the relay no 1 logic to normally open.

Note if the command is sent without an appended relay number then all the relays are assigned the set logic of normally open/closed. ▲

Send: set relay open 1

Receive: set relay open 1 ok

Record Layout Definition

The Erec, Lrec, and Srec Layouts contain the following:

- A format specifier for parsing ASCII responses
- A format specifier for parsing binary responses

In addition to these, the Erec Layout contains:

- A format specifier for producing the front-panel displays

In operation, values are read in using either the ASCII or binary format specifiers and converted to uniform internal representations (32-bit floats or 32-bit integers). These values are converted into text for display on the screen using the format specifier for the front-panel display. Normally, the specifier used to parse a particular datum from the input stream will be strongly related to the specifier used to display it (e.g., all of the floating point inputs will be displayed with an 'f' output specifier, and all of the integer inputs will be displayed with a 'd' specifier).

Format Specifier for ASCII Responses

The first line of the Layout response is the scanf-like parameter list for parsing the fields from an ASCII ERec response. Parameters are separated by spaces and the line is terminated by a `\n` (the normal line separator character). Valid fields are:

```
%s - parse a string
%d - parse a decimal number
%ld - parse a long (32-bit) decimal number
%f - parse a floating point number
%x - parse a hexadecimal number
%lx - parse a long (32-bit) hex number
%* - ignore the field
```

Note signed versus unsigned for the integer values does not matter; it is handled automatically.

Format Specifier for Binary Responses

The second line of the Layout response is the binary parameter list for parsing the fields from a binary response. Parameters **MUST** be separated by spaces, and the line is terminated by a `\n`. Valid fields are:

```
t - parse a time specifier (2 bytes)
D - parse a date specifier (3 bytes)
i - ignore one 8-bit character (1 byte)
e - parse a 24-bit floating point number (3 bytes: n/x)
E - parse a 24-bit floating point number (3 bytes: N/x)
f - parse a 32-bit floating point number (4 bytes)

c - parse an 8-bit signed number (1 byte)
C - parse an 8-bit unsigned number (1 byte)
n - parse a 16-bit signed number (2 bytes)
N - parse a 16-bit unsigned number (2 bytes)
m - parse a 24-bit signed number (3 bytes)
M - parse a 24-bit unsigned number (3 bytes)
l - parse a 32-bit signed number (4 bytes)
L - parse a 32-bit unsigned number (4 bytes)
```

There is an optional single digit *d* which may follow any of the numeric fields which indicates that after the field has been parsed out, the resulting value is to be divided by 10^d . Thus the 16-bit field `0xFFC6` would be interpreted with the format specifier `'n3'` as the number `-0.058`.

Format Specifier for Front-Panel Layout

The subsequent lines in the ERec Layout response describe the appearance of the full panel. The full instrument panel as it appears on the screen has two columns of lines. Each line is composed of three major components: (1) a text field, (2) a value field, and (3) a button. None of these three components is required. The text field contains statically displayed text.

The value field displays values which are parsed out of the response to a DATA/ERec command. It also displays, though background changes, alarm status. The button, when pressed, triggers input from either a dialog box or a selection list. There are five kinds of buttons, B, I, L, T, and N.

Each line in the layout string corresponds to one line on the display. The layout string describes each of the three major fields as well as translation mechanisms and corresponding commands.

Text The first field in the layout string is the text. It is delimited by a ':'. The string up to the first ':' will be read and inserted in the text field of the line.

Value String This is followed by a possible string, enclosed in quotes. This is used to place a string into the value field.

Value Source The value source, which is the item (or word) number in the DATA/ERec response, appears next. This is followed by an optional bitfield designator. The datum identified by the value source can be printed as a string 's', hexadecimal 'x', decimal 'd', or floating point 'f', or binary 'b' number. Typically, bitfield extractions are only done for decimal or hexadecimal numbers.

Floating-point numbers can be followed with an optional precision specifier which will be used as an argument to printf's %f format (e.g., a field of '4' would be translated into the printf command of '%.3f'). Alternately, the special character '*' can precede the precision specifier; this causes an indirection on the precision specifier (which now becomes a field number).

This is useful when formatting, for example, numbers which have varying precision depending on the mode of the instrument.

Binary numbers can also have an optional precision specifier which is used to determine how many bits to print. For example, the specifier 'b4' will print the lowest four bits of the parsed number.

There are serious restrictions on where an 's' field may appear: currently sources 1 and 2 must be 's', and no others may be 's'.

Alarm Information The value source is followed by optional alarm information, indicated by a commercial at sign '@' with a source indicator and a starting bit indicator. All alarm information is presumed to be two bits long (low and high). The bitfield extraction is performed on the integer part of the source. Typical alarm information would appear as '@6.4'.

Translation Table Then, there appears an optional translation table within braces '{}'. This is a string of words separated by spaces. An example translation table would be '{Code_0 Code_1 Code_2 Code_3}'. The value, once extracted is used as a zero-based index into the translation table to determine the string to display.

Selection Table Then there appears an optional selection table within parentheses '(...)'. This is a string of numbers separated by spaces '(0 1)'. The selection table lists the translation table entries which the user may select from when setting the parameter. This is not necessarily the same as the entries which may be displayed.

Button Designator Then there appears an optional button designator. This will be one of 'B', 'I', 'L', 'T', or 'N'.

B- Indicates a button which pops up an input dialog prompting the user for a new value using the designated input format. The input format is specified from the 'B' through the subsequent semicolon.

I—Indicates a button which pops up a selection list with input translation. That is, the values read are translated before they are compared to the selection list options.

L—Indicates a button which pops up a selection list without any translation. The output value is number of the selected option.

T—Indicates a button which pops up a selection list with output translation. The number of the option selected is used as an index into the translation table to generate an output string.

N—Indicates a button which only sends the subsequent command to the instrument. No user-prompting happens.

The following string through an optional '|' or the end of the line is the command which is to be sent to the instrument upon the completion of the button selection. The command string should normally contain print-style formatting to include the user input. If a '|' is present, it indicates a command which is sent to the instrument upon successful completion of the button command to update the value field.

This is not currently used.

Examples Some examples ('\n' is the C syntax for an end-of-line character):

```
'Concentrations\n'
```

This is a single text-only line.

```
'\n'
```

This is a single blank line.

```
' NO:3s\n'
```

This is a line which appears slightly indented. The text field is 'NO', the value is taken from the third element of the data response, and interpreted as a string.

```
' NO:18sBd.ddd;set no coef %s\n'
```

This is a line which also appears slightly indented. The next field is also 'NO', but the value is taken from the eighteenth element of the data response, again interpreted as a string. A button appears on this line which, when pressed, pops up an input dialog which will state "Please enter a new value for NO using a d.ddd format." The string entered by the user is used to construct the output command. If the user enters, for example, '1.234', the constructed command will be 'set no coef 1.234'.

```
' NO:21f{Code_0 Code_1 Code_2 Code_3 Code_4 Code_5 Code_6 Code_7  
Code_8 Code_9 Code_10 Code_11}Lset range no %d\n'
```

This is a line which appears slightly indented, the title is again 'NO', and the value the twenty-first element of the data response, interpreted as a floating-point number. There is a no-translation button which creates a selection list of twelve "Code nn" options. The number of the user selection is used to create the output command.

```
'Mode:6.12-13x{local remote service service}(0 1)Tset mode %s\n'
```

This is a line which has a title of 'Mode', and value taken from the sixth field of the data response. There is a bitfield extraction of bits 12 through 13 from the source (the value type is not important here because the value is being translated to an output string). Once the bits have been extracted, they are shifted down to the bit-zero position. Thus, the possible values of this example will be 0 through 3. The translation list shows the words which correspond to each input value, the zeroth value appearing first (0 -> local, 1 -> remote, etc.). The selection list shows that only the first two values, in this case, are to be shown to the user when the button is pressed. The 'T' button indicates full translation, input code to string, and user selection number to output string.

```
'\xC'
```

This is a line that starts a new column (the `\xC` or `^L`),

```
' Comp:6.11x{off on}Tset temp comp %s\n'
```

This shows that the bitfield end (the second part of a bitfield specification) is optional. The bitfield will be one bit long, starting in this case at the eleventh bit.

```
'Background:7f*8Bd.ddd;set o3 bkg %s\n'
```

This shows the use of indirect precision specifiers for floating point displays. The background value is taken from the 7th element, and the precision specifier is taken from the 8th. If the asterisk were not present, it would indicate instead that 8 digits after the decimal point should be displayed.

C-Link Protocol Commands

Record Layout Definition

Appendix C MODBUS Protocol

This appendix provides a description of the MODBUS Protocol Interface and is supported both over RS-232/485 (RTU protocol) as well as TCP/IP over Ethernet.

The MODBUS Commands that are implemented are explained in detail in this document. The MODBUS protocol support for the *iSeries* enables the user to perform the functions of reading the various concentrations and other analog values or variables, read the status of the digital outputs of the analyzer, and to trigger or simulate the activation of a digital input to the instrument. This is achieved by using the supported MODBUS commands listed below.

For details of the Model 42*i* High Level MODBUS Protocol specification, see the following topics:

- “Serial Communication Parameters” on page C-2 describes the parameters used to support MODBUS RTU protocol.
- “TCP Communication Parameters” on page C-2 describes the parameters used for TCP connection.
- “Application Data Unit Definition” on page C-2 describes the formats used over serial and TCP/IP.
- “Function Codes” on page C-3 describes the various function codes supported by the instrument.
- “MODBUS Commands Supported” on page C-8 lists the MODBUS commands supported in Table C-1 through Table C-3.

Additional information on the MODBUS protocol can be obtained at <http://www.modbus.org>. References are from MODBUS Application Protocol Specification V1.1a MODBUS-IDA June 4, 2004.

Serial Communication Parameters

The following are the communication parameters that are used to configure the serial port of the *iSeries* to support MODBUS RTU protocol.

- Number of Data bits : 8
- Number of Stop bits : 1
- Parity : None
- Data rate : from 1200-115200 Baud (9600 is default)

TCP Communication Parameters

iSeries Instruments support the MODBUS/TCP protocol. The register definition is the same as for the serial interface.

TCP connection port for MODBUS : 502

Application Data Unit Definition

Here are the MODBUS ADU (Application Data Unit) formats over serial and TCP/IP:

Serial:	Slave Address	Function Code	Data	Error Check
TCP/IP:	MBAP Header	Function Code	Data	

Slave Address

The MODBUS slave address is a single byte in length. This is the same as the instrument ID used for C-Link commands and can be between 1 and 127 decimal (i.e. 0x01 hex to 0x7F hex). This address is only used for MODBUS RTU over serial connections.

Note Device ID '0' used for broadcast MODBUS commands, is not supported. Device IDs 128 through 247 (i.e. 0x80 hex to 0xF7 hex) are not supported because of limitations imposed by C-Link. ▲

MBAP Header

In MODBUS over TCP/IP, a MODBUS Application Protocol Header (MBAP) is used to identify the message. This header consists of the following components:

Transaction Identifier	2 Bytes	0x0000 to 0xFFFF (Passed back in response)
Protocol Identifier	2 Bytes	0x00 (MODBUS protocol)
Length	2 Bytes	0x0000 to 0xFFFF (Number of following bytes)
Unit Identifier	1 Byte	0x00 to 0xFF (Passed back in response)

A Slave address is not required in MODBUS over TCP/IP because the higher-level protocols include device addressing. The unit identifier is not used by the instrument.

Function Code The function code is a single byte in length. The following function codes are supported by the instrument:

Read Coils	:	0x01
Read Inputs	:	0x02
Read Holding Registers	:	0x03
Read Input Registers	:	0x04
Force (Write) Single Coil	:	0x05
Read Exception Status	:	0x07

If a function code is received that is not in this list, and invalid function exception is returned.

Data The data field varies depending on the function. For more description of these data fields, see “Function Codes” below.

Error Check In MODBUS over Serial an error check is included in the message. This is not necessary in MODBUS over TCP/IP because the higher-level protocols ensure error-free transmission. The error check is a two-byte (16-bit) CRC value.

Function Codes This section describes the various function codes that are supported by the Model 42*i* High Level.

**(0x01/0x02) Read Coils /
Read Inputs**

Read Coils/Inputs reads the status of the digital outputs (relays) in the instrument. Issuing either of these function codes will generate the same response.

These requests specify the starting address, i.e. the address of the first output specified, and the number of outputs. The outputs are addressed starting at zero. Therefore, outputs numbered 1–16 are addressed as 0–15.

The outputs in the response message are packed as one per bit of the data field. Status is indicated as 1 = Active (on) and 0 = Inactive (off). The LSB of the first data byte contains the output addressed in the query. The other outputs follow toward the high order end of this byte, and from low order to high order in subsequent bytes. If the returned output quantity is not a multiple of eight, the remaining bits in the final data byte will be padded with zeros (toward the high order end of the byte). The Byte Count field specifies the quantity of complete bytes of data.

Note The values reported may not reflect the state of the actual relays in the instrument, as the user may program these outputs for either active closed or open. ▲

Request

Function code	1 Byte	0x01 or 0x02
Starting Address	2 Bytes	0x0000 to maximum allowed by instrument
Quantity of outputs	2 Bytes	1 to maximum allowed by instrument
Unit Identifier	1 Byte	0x00 to 0xFF (Passed back in response)

Response

Function code	1 Byte	0x01 or 0x02
Byte count	1 Byte	N*
Output Status	n Byte	n = N or N+1

*N = Quantity of Outputs / 8, if the remainder not equal to zero, then N=N+1

Error Response

Function code	1 Byte	Function code + 0x80
Exception code	1 Byte	01=Illegal Function, 02=Illegal Address, 03=Illegal Data, 04=Slave Device Failure

Here is an example of a request and response to read outputs 2–15:

Request

<i>Field Name</i>	<i>(Hex)</i>
Function	0x01
Starting Address Hi	0x00
Starting Address Lo	0x02
Quantity of Outputs Hi	0x00
Quantity of Outputs Lo	0x0D

Response

<i>Field Name</i>	<i>(Hex)</i>
Function	0x01
Byte Count	0x03
Outputs status 2-10	0xCD
Outputs status 11-15	0x0A

The status of outputs 2–10 is shown as the byte value 0xCD, or binary 1100 1101. Output 10 is the MSB of this byte, and output 2 is the LSB. By convention, bits within a byte are shown with the MSB to the left, and the LSB to the right. Thus the outputs in the first byte are ‘10 through 2’, from left to right. In the last data byte, the status of outputs 15-11 is shown as the byte value 0x0A, or binary 0000 1010. Output 15 is in the fifth bit position from the left, and output 11 is the LSB of this byte. The four remaining high order bits are zero filled.

(0x03/0x04) Read Holding Registers / Read Input Registers

Read holding/input registers reads the measurement data from the instrument. Issuing either of these function codes will generate the same response. These functions read the contents of one or more contiguous registers.

These registers are 16 bits each and are organized as shown below. All of the values are reported as 32-bit IEEE standard 754 floating point format. This uses 2 sequential registers, least significant 16 bits first.

The request specifies the starting register address and the number of registers. Registers are addressed starting at zero. Therefore registers numbered 1–16 are addressed as 0–15. The register data in the response message are packed as two bytes per register, with the binary contents right justified within each byte. For each register, the first byte contains the high order bits and the second contains the low order bits.

Request

Function code	1 Byte	0x03 or 0x04
Starting Address	2 Bytes	0x0000 to maximum allowed by instrument
Quantity of Registers	2 Bytes	1 to maximum allowed by instrument

Response

Function code	1 Byte	0x03 or 0x04
Byte count	1 Byte	2 x N*
Register value	N* x 2 Bytes	n = N or N+1

*N = Quantity of Registers

Error Response

Function code	1 Byte	Function code + 0x80
Exception code	1 Byte	01=Illegal Function, 02=Illegal Address, 03=Illegal Data, 04=Slave Device Failure

Here is an example of a request to read registers 10–13:

Request

<i>Field Name</i>	<i>(Hex)</i>
Function	0x03
Starting Address Hi	0x00
Starting Address Lo	0x09
No. of Registers Hi	0x00
No. of Registers Lo	0x04

Response

<i>Field Name</i>	<i>(Hex)</i>
Function	0x03
Byte Count	0x06
Register value Hi (10)	0x02
Register value Lo (10)	0x2B
Register value Hi (11)	0x00
Register value Lo (11)	0x00
Register value Hi (12)	0x00
Register value Lo (12)	0x64
Register value Hi (13)	0x00
Register value Lo (13)	0x64

The contents of register 10 are shown as the two byte values of 0x02 0x2B. The contents of registers 11–13 are 0x00 0x00, 0x00 0x64 and 0x00 0x64, respectively.

(0x05) Force (Write) Single Coil

The force (write) single coil function simulates the activation of the digital inputs in the instrument, which triggers the respective action.

This function code is used to set a single action to either ON or OFF. The request specifies the address of the action to be forced. Actions are addressed starting at zero. Therefore, action number 1 is addressed as 0. The requested ON/OFF state is specified by a constant in the request data field. A value of 0xFF00 requests the action to be ON. A value of 0x0000 requests it to be OFF. All other values are illegal and will not affect the output. The normal response is an echo of the request, returned after the state has been written.

Request

Function code	1 Byte	0x05
Output Address	2 Bytes	0x0000 to maximum allowed by instrument
Output Value	2 Bytes	0x0000 or 0xFF00

Response

Function code	1 Byte	0x05
Output Address	2 Bytes	0x0000 to maximum allowed by instrument
Output Value	2 Bytes	0x0000 or 0xFF00

Error Response

Function code	1 Byte	Function code + 0x80
Exception code	1 Byte	01=Illegal Function, 02=Illegal Address, 03=Illegal Data, 04=Slave Device Failure

Here is an example of a request to write Coil 5 ON:

Request

<i>Field Name</i>	<i>(Hex)</i>
Function	05
Output Address Hi	00
Output Address Lo	05
Output Value Hi	FF
Output Value Lo	00

Response	
<i>Field Name</i>	<i>(Hex)</i>
Function	05
Output Address Hi	00
Output Address Lo	05
Output Value Hi	FF
Output Value Lo	00

MODBUS Commands Supported

Table C-1 through Table C-3 list the MODBUS commands supported for the Model 42i High Level.

Table C-1. Read Coils for 42i High Level

Coil Number	Status
1	AUTORANGE (NO _x)
2	LOCAL/REMOTE
3	SERVICE
4	UNITS
5	ZERO MODE
6	SPAN MODE
7	NO MODE
8	NO _x MODE
9	NOT USED
10	NOT USED
11	GEN ALARM
12	NO CONC MAX ALARM
13	NO CONC MIN ALARM
14	NO ₂ CONC MAX ALARM
15	NO ₂ CONC MIN ALARM
16	NO _x CONC MAX ALARM
17	NO _x CONC MIN ALARM
18	INT TEMP ALARM
19	CHAMB TEMP ALARM
20	COOLER TEMP ALARM
21	NO ₂ CONVERTER TEMP ALARM
22	NOT USED

Table C-1. Read Coils for 42i High Level, continued

Coil Number	Status
23	NOT USED
24	PRESSURE ALARM
25	FLOW ALARM
26	OZONE FLOW ALARM
27	MOTHERBOARD STATUS ALARM
28	INTERFACE BD STATUS ALARM
29	I/O EXP BD STATUS ALARM
30	NOT USED
31	CONC ALARM
32	SAMPLE MODE

Table C-2. Read Registers for 42i High Level

Register Number	Variable
4001&40002	NO
4003&40004	NO ₂
4005&40006	NO _x
4007&40008	NOT USED
4009&40010	NOT USED
4011&40012	LO NO
4013&40014	LO NO ₂
4015&40016	LO NO _x
4017&40018	NOT USED
4019&40020	NOT USED
4021&40022	HI NO
4023&40024	HI NO ₂
4025&40026	HI NO _x
4027&40028	NOT USED
4029&40030	NOT USED
4031&40032	RANGE (NO _x)
4033&40034	NOT USED
4035&40036	INT TEMP
4037&40038	CHAMBER TEMP

Table C-2. Read Registers for 42*i* High Level, continued

Register Number	Variable
40039&40040	COOLER TEMP
40041&40042	NO ₂ CNV TEMP
40043&40044	NOT USED
40045&40046	NOT USED
40047&40048	NOT USED
40049&40050	CHAMBER PRES
40051&40052	FLOW
40053&40054	PMT VOLTS
40055&40056	ANALOG IN 1
40057&40058	ANALOG IN 2
40059&40060	ANALOG IN 3
40061&40062	ANALOG IN 4
40063&40064	ANALOG IN 5
40065&40066	ANALOG IN 6
40067&40068	ANALOG IN 7
40069&40070	ANALOG IN 8

Table C-3. Write Coils for 42*i* High Level

Coil Number	Action Triggered
101	ZERO MODE
102	SPAN MODE
103	NO MODE
104	NO _x MODE
105	NOT USED
106	NOT USED
107	SET BACKGROUND
108	CAL TO LO SPAN
109	AOUTS TO ZERO
110	AOUTS TO FS
111	CAL TO HI SPAN

Appendix D

Geysitech (Bayern-Hessen) Protocol

This appendix provides a description of the Geysitech (Bayern-Hessen or BH) Protocol Interface and is supported both over RS-232/485 as well as TCP/IP over Ethernet.

The Geysitech Commands that are implemented are explained in detail in this document. The Geysitech protocol support for the *iSeries* enables the user to perform the functions of reading the various concentrations and to trigger the instrument to be in sample/zero/span mode if valid for that instrument. This is achieved by using the supported Geysitech commands listed below.

For details of the Model 42*i* High Level Geysitech Protocol specification, see the following topics:

- [“Serial Communication Parameters”](#) on page D-1
- [“TCP Communication Parameters”](#) on page D-2
- [“Instrument Address”](#) on page D-2
- [“Abbreviations Used”](#) on page D-2
- [“Basic Command Structure”](#) on page D-2
- [“Block Checksum”](#) on page D-3
- [“Geysitech Commands”](#) on page D-3

Serial Communication Parameters

The following are the communication parameters that are used to configure the serial port of the *iSeries* to support Geysitech protocol.

Number of Data bits	: 8
Number of Stop bits	: 1
Parity	: None
Data rate	: from 1200-115200 Baud (9600 is default)

TCP Communication Parameters

iSeries Instruments support the Geysitech/TCP protocol over TCP/IP. The register definition is the same as for the serial interface.

TCP connection port for Geysitech: 9882

Instrument Address

The Geysitech instrument address has a value between 0 and 127 and is represented by 3 digit ASCII number with leading zeros or leading spaces if required (e.g. Instrument address of 1 is represented as 001 or <SP><SP>1)

The instrument Address is the same as the Instrument ID used for C-Link and MODBUS commands. This can be set via the front panel.

The Instrument Address is represented by <address> in the examples throughout this document.

Note Device IDs 128 through 247 are not supported because of limitations imposed by the C-Link protocol. ▲

Abbreviations Used

The following is a list of abbreviations used in this document:

<CR> is abbreviation for Carriage Return (ASCII code 0x0D)

<STX> is abbreviation for Start of Text (ASCII code 0x02)

<ETX> is abbreviation for End of Text (ASCII code 0x03)

<SP> is abbreviation for space (ASCII code 0x20)

Basic Command Structure

The following is the basic structure of a Geysitech command:

<STX>Command text<ETX><BCC>

OR

<STX>Command text<CR>

Each Command is framed by control characters, <STX> at the start and terminated with either <ETX> or <CR>.

If a command is terminated with <ETX> then additional two characters <BCC> is attached after <ETX>, this is the block checksum.

Block Checksum <BCC>

The block checksum is calculated beginning with a seed value of 00000000, binary (0x00), and bitwise exclusive ORing with each of the characters of the command string (or response) including the framing characters <STX> and <ETX>. The checksum works as an error check. The command terminator determines the presence or absence of <BCC>.

If a command is terminated by <ETX> then the next two characters are the checksum, if the command is terminated with <CR> no checksum is attached

The block checksum is represented by two characters, which represent a 2 digit hex number (1byte). (e.g. 1 byte 0xAB hex checksum will be represented by the two characters 'A' & 'B')

The checksum is referred to as <BCC> throughout this document.

Geysitech Commands

The following commands are supported by the Geysitech protocol:

- Instrument Control Command (ST)
- Data Sampling/Data Query Command (DA)

Instrument Control Command (ST)

There are three control commands supported by the Geysitech protocol.

This <control command> is a single letter, which triggers an action in the instrument. These commands are active only when service mode is inactive and the zero/span option is present.

Command 'N' switches the instrument gas mode to Zero mode.

Command 'K' switches the instrument gas mode to Span mode.

Command 'M' switches the instrument gas mode to Sample mode.

The following are the different acceptable formats of the ST command:

<STX>ST<address><control command><ETX><BCC>

OR

<STX>ST<address><control command><CR>

OR

<STX>ST<address><SP><control command><CR>

OR

<STX>ST<address><SP><control command><ETX><BCC>

The <address> is optional, which means it can be left out completely. The <address> if present must match the Instrument Address. Additional space can be present after the <address>.

If the received command does not satisfy the above formats or if the <address> does not match the Instrument Address the command is ignored.

This is a sample command to switch the instrument to zero mode, instrument id 5:

```
<STX>ST005<SP>N<CR>
```

Data Sampling/Data Query Command (DA)

This command DA initiates a data transfer from the instrument. The instrument responds with measurement data, which depends on the range mode and is listed in “[Measurements reported in response to DA command](#)” below.

The command structure for a data query command is as follows:

```
<STX>DA<address><ETX><BCC>
```

The <address> is optional, which means it can be left out completely. The <address> if present must match the Instrument Address. Additional space can be present after the <address>.

If the <address> is left out then no space is allowed in the query string.

A command with no address is also a valid command.

The following are the different acceptable formats of the DA command with Instrument Address 5:

```
<STX>DA<CR>
```

```
<STX>DA005<CR>
```

```
<STX>DA<SP><SP>5<ETX><BCC>
```

```
<STX>DA<ETX><BCC>
```

The data query string is valid and will be answered with data transmission only if the command starts with <STX> which is followed by the characters DA, and the <address> (if present) matches the Instrument Address, and the command is terminated with either <CR> with no checksum or <ETX> followed by the correct checksum <BCC>.

Sample Data Reply String in response to Data Query Command (DA):

In response to a valid data query command (DA) the instrument responds in the following format:

```
<STX>MD02<SP><address><SP><measured
value1><SP><status><SP><SFKT><SP><address+1><SP><measured
value2><SP><status><SP><SFKT><ETX><BCC>
```

The response uses the same command terminators as used by the received command i.e. if the received command was terminated with a <CR> the response is terminated with <CR> and if the command was terminated with a <ETX><BCC> the response is terminated with <ETX> and the computed checksum <BCC>.

The 02 after the MD indicates, that two measurements are present in the reply string, (a 03 for three measurements and so on, this will also determine the length of the reply string).

<address> is the Instrument Address. Each subsequent measurement attached to the response will have the <address + X> where X keeps incrementing by 1 for each measurement included.

<measured value> is the concentration value in currently selected gas units represented as exponential representation with 4 characters mantissa and 2 characters exponent, each with sign.

Mantissa: sign and 4 digits. The decimal point is assumed to be after the first digit and is not transmitted.

Exponent: sign and 2 digits.

Example:

-5384000.0 is represented as -5384+06

+0.04567 is represented as +4567-02

<status>: is formed by < operating status > and < error status > and separated by a space i.e.

```
<operating status><SP><error status>
```

Each of the two (<operating status> and <error status>) are formed by two characters each representing a 2 digit hex number which is one byte (8 Bits) operation status and one byte (8 Bits) error status.

These two bytes contain the information about the main operating conditions of the instrument at that instant. For details on how to interpret the status bytes refer to [Table D-1](#) and [Table D-2](#) below.

<SFKT>: is the space provided for future use for special function, it currently contains a string of ten 0's i.e. <0000000000>.

Operating and Error Status

See [Table D-1](#) for operating status and [Table D-2](#) for error status for the Model 42*i* High Level.

Table D-1. Operating Status for Model 42*i* High Level

	D7	D6	D5	D4		D3	D2	D1	D0
→ Bit	8	7	6	5		4	3	2	1
→ Hex-value	80	40	20	10		08	04	02	01
	MSB					LSB			
Operating status:									
Service Mode (On)	0	0	0	0		0	0	0	1
Maintenance (Local)	0	0	0	0		0	0	1	0
Zero gas (On)	0	0	0	0		0	1	0	0
Span gas (On)	0	0	0	0		1	0	0	0
Gas Unit Indication (ppm OR ppb)	0	0	0	1		0	0	0	0
Ozonator (Off)	0	0	1	0		0	0	0	0
PMT (Off)	0	1	0	0		0	0	0	0
Not used	1	0	0	0		0	0	0	0

Table D-2. Error Status for Model 42*i* High Level

	D7	D6	D5	D4		D3	D2	D1	D0
→ Bit	8	7	6	5		4	3	2	1
→ Hex-value	80	40	20	10		08	04	02	01
	MSB					LSB			
Error status:									
Not Used	0	0	0	0		0	0	0	1
Not Used	0	0	0	0		0	0	1	0
Not Used	0	0	0	0		0	1	0	0
Any Temperature Alarm	0	0	0	0		1	0	0	0
Pressure Alarm	0	0	0	1		0	0	0	0
Sample Flow Alarm	0	0	1	0		0	0	0	0
Ozonator Flow Alarm	0	1	0	0		0	0	0	0
Not used	1	0	0	0		0	0	0	0

